

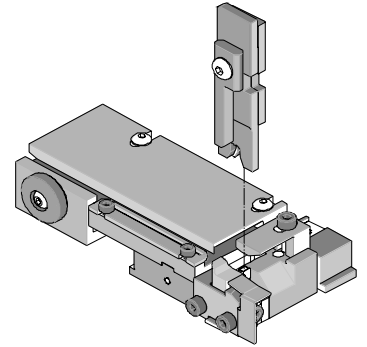

T2 Terminator Tooling Specification Sheet Part No. 63859-0200



FEATURES

- It is ideally suited for mid-volume bench operations
- This terminator can be installed in the TM42 and the TM40 press or Base Unit adapter for 3BF press
- Quick punch removal with the push of a button for fast and easy tooling change
- Track adjustment capabilities in the T2 Terminators for improved control of the bell mouth size and cutoff tab length
- T2 Terminator has standardized tooling with the Molex FineAdjust Applicator which will reduce your inventory requirements

SCOPE

Products: Micro-Fit 3.0™ Crimp Terminal, Male and Female, 20-24 AWG.

Terminal Series No.	Terminal Order No.		Wire Size		Insulation Diameter		Strip Length	
			AWG	mm ²	mm	In.	mm	In.
43030	43030-0001	43030-0051	20-24	0.50-0.20	1.10-1.30	.043-.051	2.54-2.92	.100-.115
	43030-0002	43030-0052						
	43030-0003	43030-0053						
43031	43031-0001	43031-0051	20-24	0.50-0.20	1.10-1.30	.043-.051	2.54-2.92	.100-.115
	43031-0002	43031-0052						
	43031-0003	43031-0053						
	43031-0017	43031-0102						
	43031-0018	43031-0103						
44372	44372-0002	44372-3606	20-24	0.50-0.20	1.10-1.30	.043-.051	2.54-2.92	.100-.115

⚠ This Terminator will crimp small wire insulation diameter above.
 Terminator 63850-8100 should be used for insulation OD 1.30-1.85mm (.051-.073 inch).
 Terminator 63859-0300 should be used for insulation OD 0.91-1.09 mm (.036-.043 inch).

DEFINITION OF TERMS

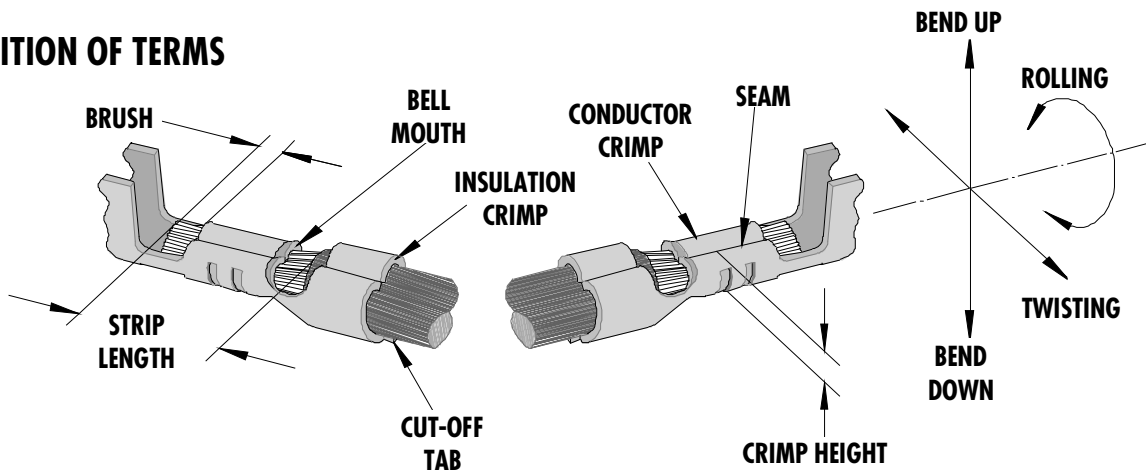

The above terminal drawing is a generic terminal representation. It is not an image of a terminal listed in the scope.

CRIMP SPECIFICATION

Terminal Series No.	Bell mouth		Cut-off Tab Max.		Conductor Brush	
	mm	In.	mm	In.	mm	In.
43030	0.05-0.40	.002-.016	0.15	.006	0.20-0.80	.008-.031
43031	0.05-0.40	.002-.016	0.15	.006	0.20-0.80	.008-.031
44372	0.05-0.40	.002-.016	0.15	.006	0.20-0.80	.008-.031

Terminal Series No.	Bend up	Bend down	Twist	Roll	Punch Width mm (Ref)				Seam
					Conductor		Insulation		
	Degree	Degree	mm	In	mm	In			
43030	3	3	4	8	1.40	.055	1.60	.063	Seam shall not be open and no wire allowed out of the crimping area
43031	3	3	4	8	1.40	.055	1.60	.063	
44372	3	3	4	8	1.40	.055	1.60	.063	

After crimping, the conductor profile should measure the following.

Terminal Order No.	Wire Size		Conductor Crimp Height		Insulation Crimp Height		Pull Force Min.	
	AWG	mm ²	mm	In.	mm	In.	N	Lb.
43030-0001	20	0.50	0.91-0.99	.036-.039	2.30 max	.090 max	57.9	13.0
	22	0.35	0.84-0.91	.033-.036	2.30 max	.090 max	35.6	8.0
	24	0.20	0.79-0.84	.031-.033	2.30 max	.090 max	22.3	5.0
43030-0002	20	0.50	0.91-0.99	.036-.039	2.30 max	.090 max	57.9	13.0
	22	0.35	0.84-0.91	.033-.036	2.30 max	.090 max	35.6	8.0
	24	0.20	0.79-0.84	.031-.033	2.30 max	.090 max	22.3	5.0
43030-0003	20	0.50	0.91-0.99	.036-.039	2.30 max	.090 max	57.9	13.0
	22	0.35	0.84-0.91	.033-.036	2.30 max	.090 max	35.6	8.0
	24	0.20	0.79-0.84	.031-.033	2.30 max	.090 max	22.3	5.0
43030-0051	20	0.50	0.91-0.99	.036-.039	2.30 max	.090 max	57.9	13.0
	22	0.35	0.84-0.91	.033-.036	2.30 max	.090 max	35.6	8.0
	24	0.20	0.79-0.84	.031-.033	2.30 max	.090 max	22.3	5.0
43030-0052	20	0.50	0.91-0.99	.036-.039	2.30 max	.090 max	57.9	13.0
	22	0.35	0.84-0.91	.033-.036	2.30 max	.090 max	35.6	8.0
	24	0.20	0.79-0.84	.031-.033	2.30 max	.090 max	22.3	5.0
43030-0053	20	0.50	0.91-0.99	.036-.039	2.30 max	.090 max	57.9	13.0
	22	0.35	0.84-0.91	.033-.036	2.30 max	.090 max	35.6	8.0
	24	0.20	0.79-0.84	.031-.033	2.30 max	.090 max	22.3	5.0
43031-0001	20	0.50	0.91-0.99	.036-.039	2.30 max	.090 max	57.9	13.0
	22	0.35	0.84-0.91	.033-.036	2.30 max	.090 max	35.6	8.0
	24	0.20	0.79-0.84	.031-.033	2.30 max	.090 max	22.3	5.0
43031-0002	20	0.50	0.91-0.99	.036-.039	2.30 max	.090 max	57.9	13.0
	22	0.35	0.84-0.91	.033-.036	2.30 max	.090 max	35.6	8.0
	24	0.20	0.79-0.84	.031-.033	2.30 max	.090 max	22.3	5.0
43031-0003	20	0.50	0.91-0.99	.036-.039	2.30 max	.090 max	57.9	13.0
	22	0.35	0.84-0.91	.033-.036	2.30 max	.090 max	35.6	8.0
	24	0.20	0.79-0.84	.031-.033	2.30 max	.090 max	22.3	5.0
43031-0017	20	0.50	0.91-0.99	.036-.039	2.30 max	.090 max	57.9	13.0
	22	0.35	0.84-0.91	.033-.036	2.30 max	.090 max	35.6	8.0
	24	0.20	0.79-0.84	.031-.033	2.30 max	.090 max	22.3	5.0
43031-0018	20	0.50	0.91-0.99	.036-.039	2.30 max	.090 max	57.9	13.0
	22	0.35	0.84-0.91	.033-.036	2.30 max	.090 max	35.6	8.0
	24	0.20	0.79-0.84	.031-.033	2.30 max	.090 max	22.3	5.0

T2 Terminator Micro-Fit 3.0™ Crimp Terminals

Terminal Order No.	Wire Size		Conductor Crimp Height		Insulation Crimp Height		Pull Force Min.	
	AWG	mm ²	mm	In.	mm	In.	N	Lb.
43031-0051	20	0.50	0.91-0.99	.036-.039	2.30 max	.090 max	57.9	13.0
	22	0.35	0.84-0.91	.033-.036	2.30 max	.090 max	35.6	8.0
	24	0.20	0.79-0.84	.031-.033	2.30 max	.090 max	22.3	5.0
43031-0052	20	0.50	0.91-0.99	.036-.039	2.30 max	.090 max	57.9	13.0
	22	0.35	0.84-0.91	.033-.036	2.30 max	.090 max	35.6	8.0
	24	0.20	0.79-0.84	.031-.033	2.30 max	.090 max	22.3	5.0
43031-0053	20	0.50	0.91-0.99	.036-.039	2.30 max	.090 max	57.9	13.0
	22	0.35	0.84-0.91	.033-.036	2.30 max	.090 max	35.6	8.0
	24	0.20	0.79-0.84	.031-.033	2.30 max	.090 max	22.3	5.0
43031-0102	20	0.50	0.91-0.99	.036-.039	2.30 max	.090 max	57.9	13.0
	22	0.35	0.84-0.91	.033-.036	2.30 max	.090 max	35.6	8.0
	24	0.20	0.79-0.84	.031-.033	2.30 max	.090 max	22.3	5.0
43031-0103	20	0.50	0.91-0.99	.036-.039	2.30 max	.090 max	57.9	13.0
	22	0.35	0.84-0.91	.033-.036	2.30 max	.090 max	35.6	8.0
	24	0.20	0.79-0.84	.031-.033	2.30 max	.090 max	22.3	5.0
44372-0002	20	0.50	0.91-0.99	.036-.039	2.30 max	.090 max	57.9	13.0
	22	0.35	0.84-0.91	.033-.036	2.30 max	.090 max	35.6	8.0
	24	0.20	0.79-0.84	.031-.033	2.30 max	.090 max	22.3	5.0
44372-3606	20	0.50	0.91-0.99	.036-.039	2.30 max	.090 max	57.9	13.0
	22	0.35	0.84-0.91	.033-.036	2.30 max	.090 max	35.6	8.0
	24	0.20	0.79-0.84	.031-.033	2.30 max	.090 max	22.3	5.0

Pull Force should be measured with no influence from the insulation crimp.

The above specifications are guidelines to an optimum crimp.

PARTS LIST

Terminator 63859-0200				
Item	Order No	Engineering No.	Description	Quantity
Perishable Tooling				
	63859-0270	63859-0270	Tool Kit (All "Y" Items)	REF
1	63444-1421	63444-1421	Conductor Punch	1 Y
2	63445-1436	63445-1436	Conductor Anvil	1 Y
3	63446-1610	63446-1610	Insulation Punch	1 Y
4	63445-1614	63445-1614	Insulation Anvil	1 Y
5	63443-0002	63443-0002	Cut-Off Plunger	1 Y
6	63443-0012	63443-0012	Front Plunger Retainer	1 Y
Other Components				
7	11-18-4083	60707-8	Front Cover	1
8	11-24-1067	4996-4	Cut-off Plunger Spring	1
9	11-40-4039	8302-5	Front Plunger Striker	1
10	63443-0009	63443-0009	Scrape Chute	1
11	63443-0021	63443-0021	Lower Tooling Key	1
12	63443-2409	63443-2409	Anvil Mount	1
13	63443-4005	63443-4005	Wire Stop	1
14	63443-6003	63443-6003	Rear Cover	1
Frame				
15	63800-8500	63800-8500	T2 Terminator	1
Hardware				
16	N/A	N/A	M3 by 6 Long SHCS	2**
17	N/A	N/A	M4 by 6 Long SHCS	1**
18	N/A	N/A	M4 by 10 Long BHCS	2**
19	N/A	N/A	M4 by 20 Long SHCS	1**
20	N/A	N/A	M4 by 50 Long SHCS	1**
21	N/A	N/A	M4 by 16 Long SHCS	1**
22	N/A	N/A	3MM by 6 Long Roll Pin	1**
23	N/A	N/A	#10-32 by 1/4" Long BHCS	1**

** Available from an industrial supply company such as MSC (1-800-645-7270).

Assembly Drawing

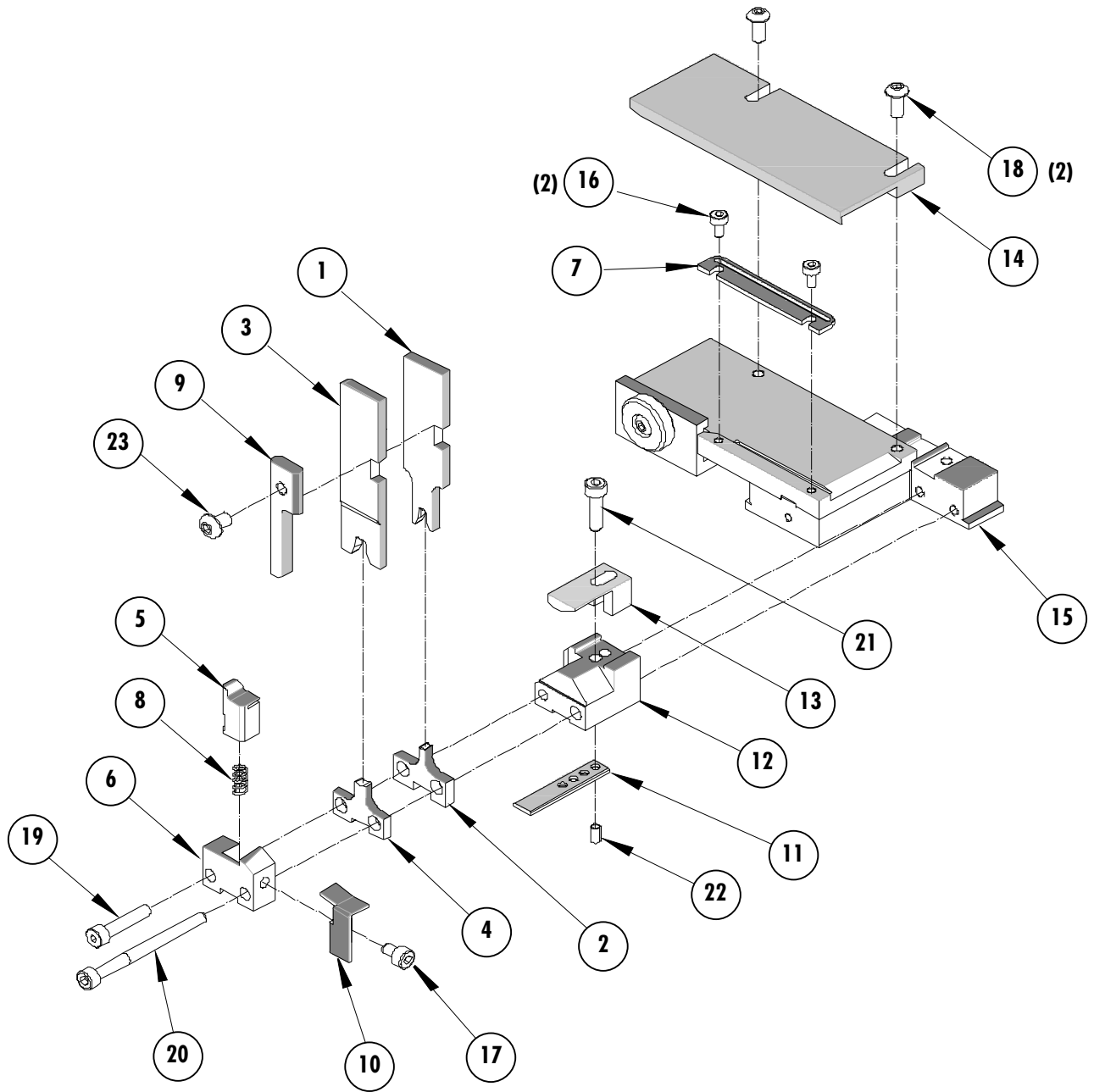

Figure 1

NOTES

Depending on the press vintage a feed finger assembly is supplied with the T2 Terminator.

1. To remove the existing feed finger assembly loosens the M4 x 10 mm set screw in the feed lever.
2. Select T2 Feed finger assembly from Terminator box.
3. Insert a screwdriver into the slot behind the feed lever and force the feed arm spring to the right.
4. Slide the T2 feed finger shaft for TM42 (11-40-5307) or (11-40-0123) for TM40 /Base Unit into the feed lever and to the left of the feed arm spring.
5. Release the feed arm spring.
6. Position feed finger for selected product. (Refer to Figure 5.1 in the T2 Manual).

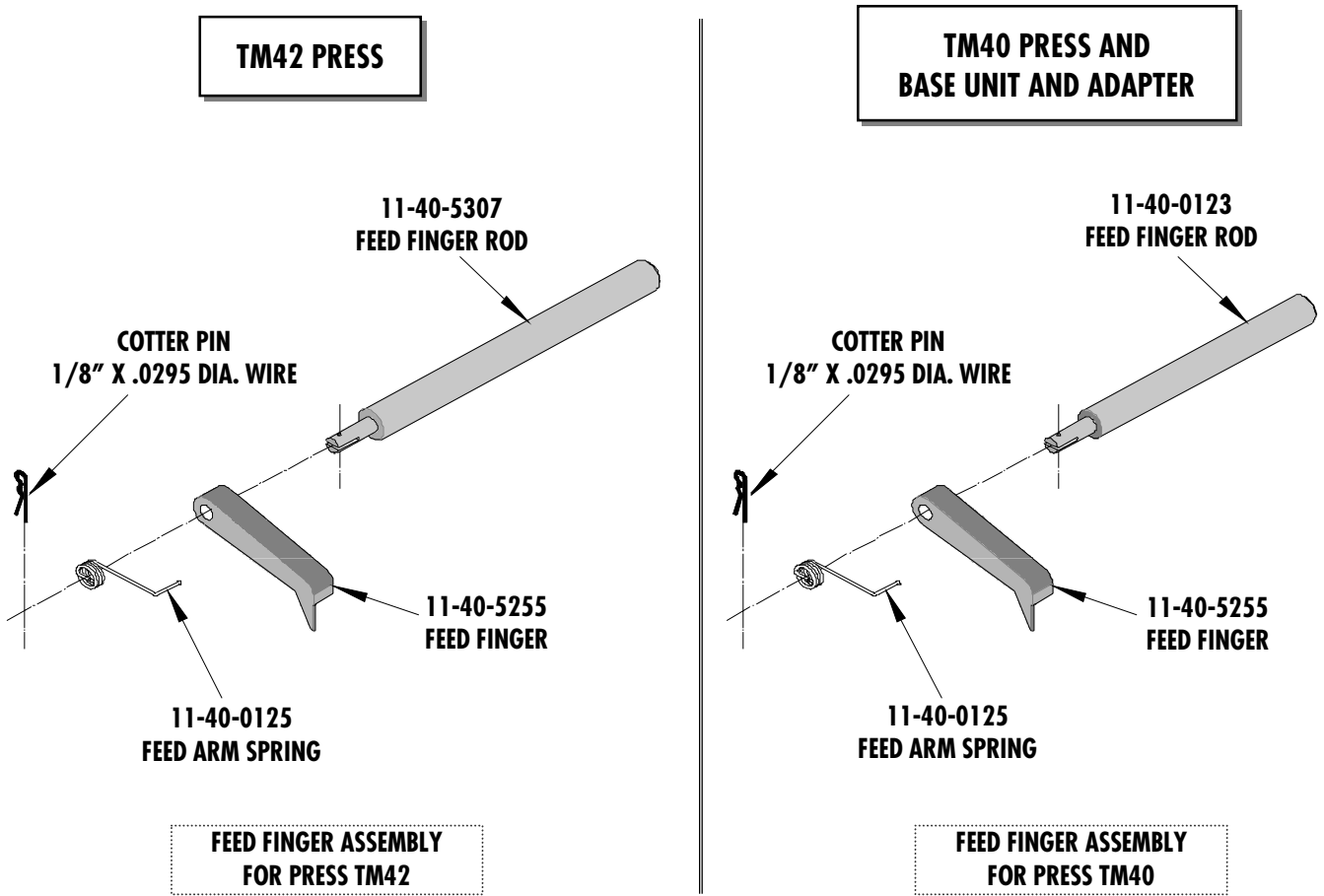

Figure 2

NOTES

1. Molex recommends an extra perishable tooling kit be maintained at your facility.
2. Verify tooling alignment by manually cycling the press before crimping under power. Check that all screws are tight.
3. Slugs, Terminals, Dirt and Oil should be kept clear of work area.
4. This Terminator should be only used in a Molex TM42, TM40, or 3BF Press with a Base Unit adaptor.
5. Wear safety glasses at all times.
6. For recommended maintenance refer to the TM40, TM42 Manual.

CAUTION: To prevent injury never operate this Terminator without the guards supplied with the press in place. Reference the TM42 press manufacturer's instruction manual.

CAUTION: Molex crimp specifications are valid only when used with Molex terminals, applicators and tooling.

Americas Headquarters

Lisle, Illinois 60532 U.S.A.
1-800-78MOLEX
amerinfo@molex.com

Far East North Headquarters

Yamato, Kanagawa, Japan
81-462-65-2324
feninfo@molex.com

Far East South Headquarters

Jurong, Singapore
65-6-268-6868
fesinfo@molex.com

European Headquarters

Munich, Germany
49-89-413092-0
eurinfo@molex.com

Corporate Headquarters

2222 Wellington Ct.
Lisle, IL 60532 U.S.A.
630-969-4550
Fax: 630-969-1352

Visit our Web site at <http://www.molex.com>

Mouser Electronics

Authorized Distributor

Click to View Pricing, Inventory, Delivery & Lifecycle Information:

[Molex:](#)

[63859-0270](#)