

Single/Dual/Quad, SOT23, Single-Supply, High-Speed, Low-Power Comparators

General Description

The MAX976/MAX978/MAX998 dual/quad/single, high-speed, low-power comparators are optimized for +3V/+5V single-supply applications. They achieve a 20ns propagation delay while consuming only 225µA supply current per comparator. The MAX998 features a low-power shutdown mode that places the output in a high-impedance state and reduces supply current to 1nA.

The MAX976/MAX978/MAX998 inputs have a common-mode voltage range that extends 200mV below ground. Their outputs are capable of rail-to-rail operation without external pullup circuitry, making these devices ideal for interface with CMOS/TTL logic. All inputs and outputs can tolerate a continuous short-circuit fault condition to either rail. The comparators' internal hysteresis ensures clean output switching, even with slow-moving input signals.

For space-critical applications, the single MAX998 is available in a 6-pin SOT23 package, the dual MAX976 is available in an 8-pin µMAX® package, and the quad MAX978 is available in a 16-pin QSOP package.

Applications

- Battery-Powered Systems
- Threshold Detectors/Discriminators
- 3V Systems
- IR Receivers
- Digital Line Receivers

Typical Operating Circuit

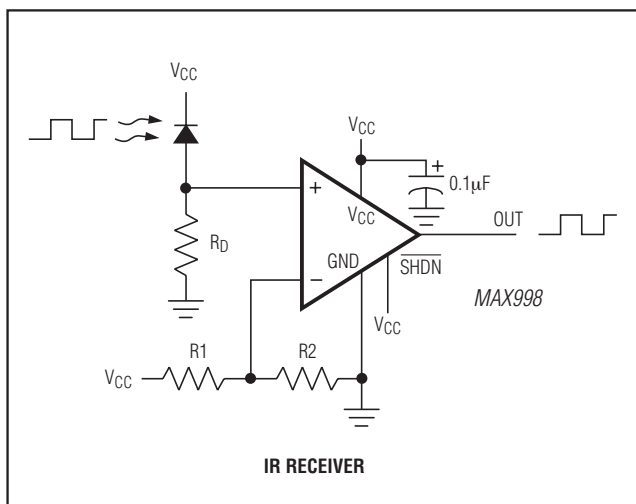

µMAX a registered trademark of Maxim Integrated Products, Inc.

Features

- ◆ Single-Supply Operation Down to 2.7V
- ◆ 20ns Propagation Delay
- ◆ 225µA Supply Current
- ◆ 1nA Shutdown Supply Current
- ◆ Rail-to-Rail Outputs
- ◆ Ground-Sensing Inputs
- ◆ Internal Hysteresis Ensures Clean Switching
- ◆ Available in Space-Saving Packages
 - SOT23 (MAX998)
 - µMAX (MAX976)
 - QSOP (MAX978)

Ordering Information

PART	PIN-PACKAGE	SOT23 TOP MARK
MAX976ESA+	8 SO	—
MAX976EUA+	8 µMAX	—
MAX978ESE+	16 Narrow SO	—
MAX978EEE+	16 QSOP	—
MAX998ESA+	8 SO	—
MAX998EUT+T	6 SOT23	AAAO

Note: All devices are specified over the -40°C to +85°C temperature range.

+ Denotes a lead(Pb)-free/RoHS-compliant package.

Pin Configurations

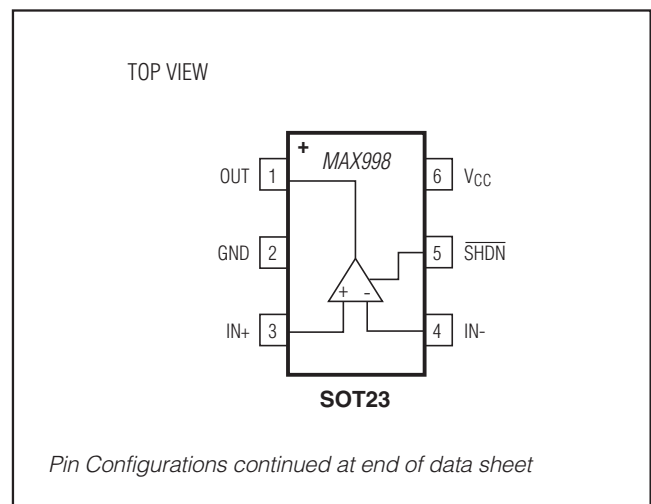

MAX976/MAX978/MAX998

Single/Dual/Quad, SOT23, Single-Supply, High-Speed, Low-Power Comparators

ABSOLUTE MAXIMUM RATINGS

Supply Voltage (V _{CC}).....+6V	8-Pin SO (derate 5.88mW/°C above +70°C).....471mW
SHDN (MAX998).....-0.3V to 6V	16-Pin Narrow SO (derate 8.70mW/°C above +70°C) ..696mW
All Other Pins.....-0.3V to (V _{CC} + 0.3V)	16-Pin QSOP (derate 8.33mW/°C above +70°C).....667mW
Current into Input Pins.....±20mA	Operating Temperature Range-40°C to +85°C
Duration of Output Short Circuit to GND or V _{CC}Continuous	Storage Temperature Range-65°C to +160°C
Continuous Power Dissipation (T _A = +70°C)	Lead Temperature (soldering, 10s).....+300°C
6-Pin SOT23-6 (derate 7.1mW/°C above +70°C)571mW	Soldering Temperature (reflow).....+260°C
8-Pin µMAX (derate 4.10mW/°C above +70°C)330mW	

Stresses beyond those listed under "Absolute Maximum Ratings" may cause permanent damage to the device. These are stress ratings only, and functional operation of the device at these or any other conditions beyond those indicated in the operational sections of the specifications is not implied. Exposure to absolute maximum rating conditions for extended periods may affect device reliability.

ELECTRICAL CHARACTERISTICS

(V_{CC} = +2.7V to +5.5V, V_{CM} = 0V, T_A = -40°C to +85°C, unless otherwise noted. Typical values are at T_A = +25°C.) (Note 1)

PARAMETER	SYMBOL	CONDITIONS	MIN	TYP	MAX	UNITS	
Supply Voltage Range	V _{CC}	Inferred from PSRR test	2.7		5.5	V	
Supply Current per Comparator	I _{CC}	V _{CC} = 5.5V		300	650	µA	
		V _{CC} = 2.7V		225			
Shutdown Supply Current	I _{SD}	MAX998 only, $\overline{\text{SHDN}} = \text{GND}$		1	500	nA	
Power-Supply Rejection Ratio	PSRR	2.7V < V _{CC} < 5.5V	63	100		dB	
Common-Mode Voltage Range	V _{CMR}	(Note 2)	-0.2	V _{CC} - 1.2		V	
Common-Mode Rejection Ratio	CMRR	-0.2V ≤ V _{CM} ≤ (V _{CC} - 1.2V)	66	95		dB	
Input Offset Voltage	V _{OS}	V _{CC} = 5V (Note 3)	T _A = +25°C	0.2	±2	mV	
			T _A = T _{MIN} to T _{MAX}				±3
Input-Referred Hysteresis	V _{HYS}	V _{CC} = 5V (Note 4)	MAX976EUA, MAX998EUT	0.3	1.5	5.0	mV
			All others	0.5	1.5	4.0	
Input Bias Current	I _B			75	300	nA	
Input Offset Current	I _{OS}			±5	±100	nA	
OUT Output-Voltage High	V _{OH}	I _{SOURCE} = 2mA, V _{CC} - V _{OH}		0.1	0.4	V	
OUT Output-Voltage Low	V _{OL}	I _{SINK} = 2mA		0.1	0.4	V	
OUT Short-Circuit Current	I _{SH}	V _{CC} = 5.5V	Sinking		74	mA	
			Sourcing		90		
Input Capacitance	C _{IN}			3		pF	
$\overline{\text{SHDN}}$ Input-Voltage High	V _{IH}	MAX998 only	0.65 x V _{CC}			V	
$\overline{\text{SHDN}}$ Input-Voltage Low	V _{IL}	MAX998 only			0.2 x V _{CC}	V	
OUT Leakage Current	I _{OUT}	MAX998 only, $\overline{\text{SHDN}} = \text{GND}$, V _{OUT} = 0V to V _{CC}		1	200	nA	
$\overline{\text{SHDN}}$ Input Current	I _{SHDN}	MAX998 only		1	200	nA	
Propagation Delay	t _{PD}	C _{LOAD} = 10pF, V _{CC} = 5V (Note 5)	Overdrive = 5mV	28		ns	
			Overdrive = 50mV	20	40		
Propagation-Delay Skew	t _{SKEW}	C _{LOAD} = 10pF (Note 6)		2		ns	
Propagation-Delay Matching Between Channels	Δt _{PD}	MAX976/MAX978 only		1		ns	
Output Rise/Fall Time	t _R /t _F	C _{LOAD} = 10pF		1.6		ns	
Shutdown Delay Time	t _{SD}	MAX998 only, V _{CC} = 5V, I _{CC} = 10% of typical		5		µs	

MAX976/MAX978/MAX998

Single/Dual/Quad, SOT23, Single-Supply, High-Speed, Low-Power Comparators

ELECTRICAL CHARACTERISTICS (continued)

($V_{CC} = +2.7V$ to $+5.5V$, $V_{CM} = 0V$, $T_A = -40^\circ C$ to $+85^\circ C$, unless otherwise noted. Typical values are at $T_A = +25^\circ C$.) (Note 1)

PARAMETER	SYMBOL	CONDITIONS	MIN	TYP	MAX	UNITS
Wake-Up from Shutdown	t_{EN}	MAX998 only, $V_{CC} = 5V$, $I_{CC} = 90\%$ of typical (Note 7)		15		μs
Power-Up Delay	t_{PU}	$V_{CC} = 0V$ to $5V$ step, output valid		3		μs

Note 1: The MAX998EUT specifications are 100% tested at $T_A = +25^\circ C$. Limits over the extended temperature range are guaranteed by design, not production tested.

Note 2: Inferred from CMRR test. Either input can be driven to the absolute maximum limit without false output inversion, as long as the other input is within the common-mode voltage range.

Note 3: V_{OS} is defined as the mean of trip points. The trip points are the extremities of the differential input voltage required to make the comparator output change state (Figure 1).

Note 4: The difference between the upper and lower trip points is equal to the width of the input-referred hysteresis zone (Figure 1).

Note 5: Propagation Delay is guaranteed by design. For low overdrive conditions, V_{TRIP} (Figure 1) is added to the overdrive.

Note 6: Propagation-Delay Skew is the difference between the positive-going and the negative-going propagation delay.

Note 7: For design purposes, the t_{EN} can be as high as $60\mu s$.

Typical Operating Characteristics

($V_{CC} = +5V$, $V_{CM} = 0V$, $T_A = +25^\circ C$, unless otherwise noted.)



MAX976/MAX978/MAX998

Single/Dual/Quad, SOT23, Single-Supply, High-Speed, Low-Power Comparators

Typical Operating Characteristics (continued)

($V_{CC} = +5V$, $V_{CM} = 0V$, $T_A = +25^\circ C$, unless otherwise noted.)

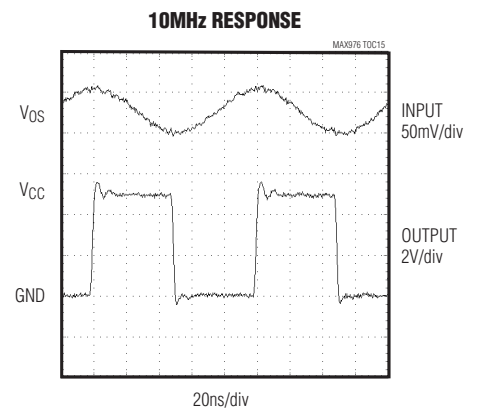
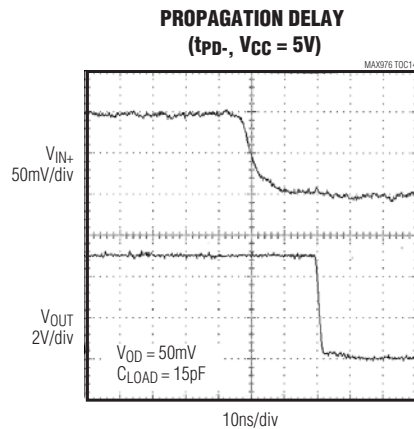
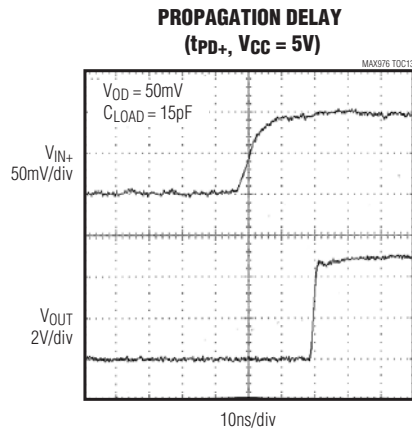
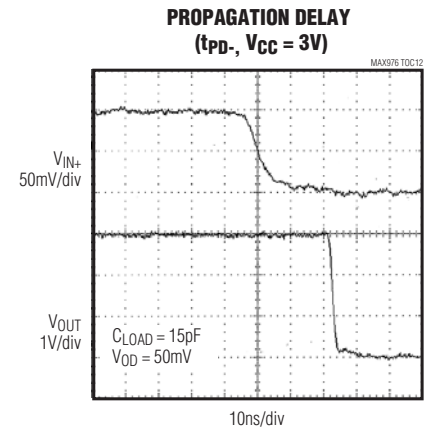
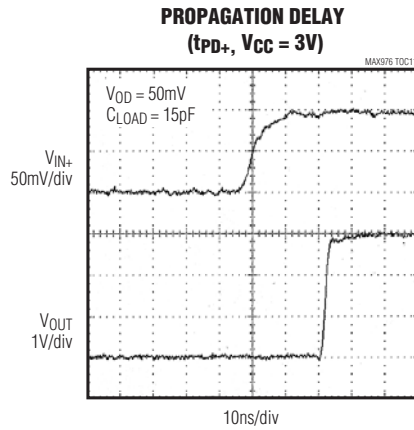
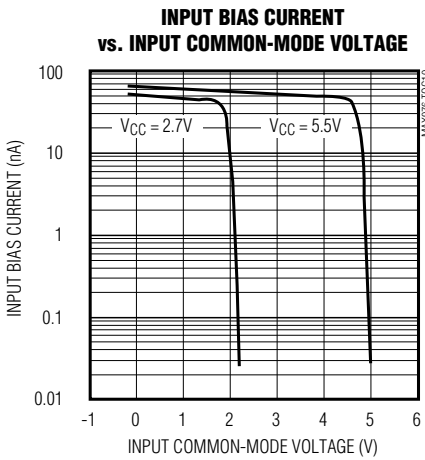
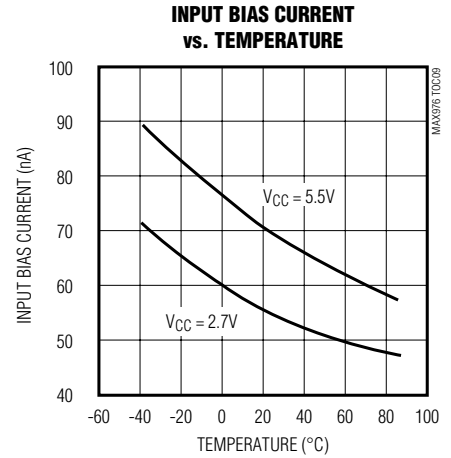
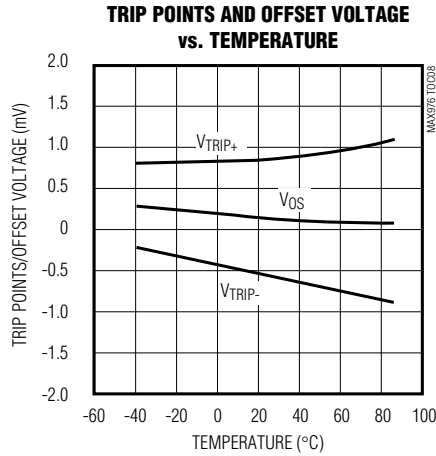
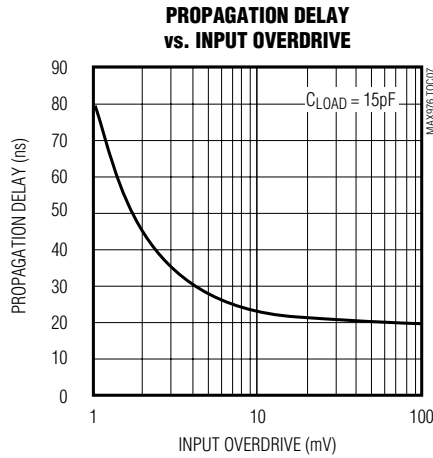

MAX976/MAX978/MAX998

Single/Dual/Quad, SOT23, Single-Supply, High-Speed, Low-Power Comparators

Typical Operating Characteristics (continued)

($V_{CC} = +5V$, $V_{CM} = 0V$, $T_A = +25^\circ C$, unless otherwise noted.)

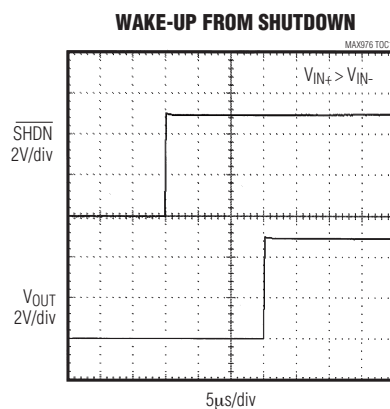
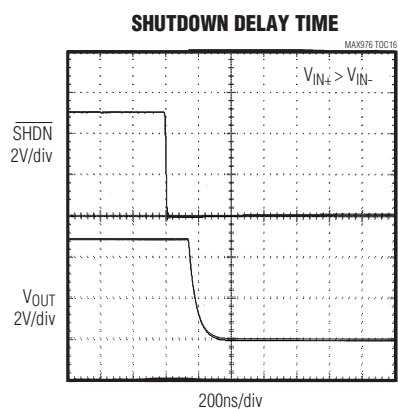

Pin Description

PIN				NAME	FUNCTION
MAX976	MAX978	MAX998			
SO/ μ MAX	SO/QSOP	SOT23-6	SO		
1, 3	1, 3, 5, 7	3	3	IN ₊	Comparator Noninverting Input
2, 4	2, 4, 6, 8	4	2	IN ₋	Comparator Inverting Input
5	9, 13	2	4	GND	Ground
6, 7	10, 11, 14, 15	1	6	OUT ₋	Comparator Output
8	12, 16	6	7	V _{CC}	Supply Voltage, +2.7V to +5.5V
—	—	—	1, 5	N.C.	No Connection. Not internally connected.
—	—	5	8	$\overline{\text{SHDN}}$	Shutdown Input. Drive low for shutdown mode. Drive high or connect to V _{CC} for normal operation.

Detailed Description

The MAX976/MAX978/MAX998 dual/quad/single comparators operate from a single +2.7V to +5.5V supply. They achieve a 20ns propagation delay while consuming only 225 μ A of supply current per comparator. The MAX998 features a low-power shutdown mode that places the output in a high-impedance state and reduces supply current to 1nA. Activate shutdown mode by driving $\overline{\text{SHDN}}$ low.

The MAX976/MAX978/MAX998 comparator inputs have a common-mode voltage range of -0.2V to ($V_{CC} - 1.2V$).

Either input can be driven to the Absolute Maximum Ratings limit without false output inversion, as long as the other input is within the Common-Mode Voltage Range. Their push/pull output structure is capable of rail-to-rail operation without external pull-up circuitry, making these devices ideal for interfacing with CMOS/TTL logic. All inputs and outputs can tolerate a continuous short-circuit fault condition to either supply. The comparator's internal hysteresis ensures clean output switching, even with slow-moving input signals.

MAX976/MAX978/MAX998

Single/Dual/Quad, SOT23, Single-Supply, High-Speed, Low-Power Comparators

Hysteresis

High-speed comparators can oscillate in the linear operating region because of noise or undesired parasitic feedback. This tends to occur when the voltage on one input is equal to or very close to the voltage on the other input. The MAX976/MAX978/MAX998 have internal hysteresis to counter parasitic effects and noise. The hysteresis in a comparator creates two trip points: one for the rising input voltage and one for the falling input voltage (Figure 1). The difference between the trip points is the hysteresis. When the comparator input voltages are equal, the hysteresis effectively causes one comparator input voltage to move quickly past the other, taking the input out of the region where oscillation occurs.

Figure 1 illustrates the case where IN- has a fixed voltage applied and IN+ is varied. If the inputs were reversed, the figure would be the same, except with an inverted output.

Input-Stage Circuitry

The MAX976/MAX978/MAX998 input common-mode voltage range is from -0.2V to ($V_{CC} - 1.2V$). The voltage range for each comparator input extends to both V_{CC} and GND. The output remains in the correct logic state while one or both of the inputs are within the common-mode range. If both input levels are out of the common-mode range, input-stage current saturation occurs, and the output becomes unpredictable.

Shutdown Mode

The MAX998 features a low-power shutdown mode, which is activated by forcing \overline{SHDN} low. Shutdown mode reduces the supply current to 1nA (typical), disables the comparator, and places the output in a high-impedance state. Drive \overline{SHDN} high to enable the comparator. Do not leave \overline{SHDN} unconnected. Since it is a high-impedance input, leaving \overline{SHDN} unconnected could result in indeterminate logic levels, adversely

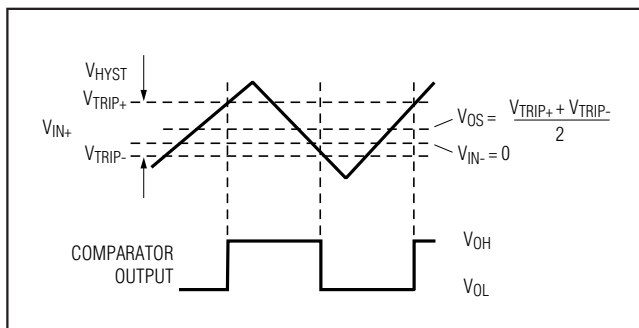

Figure 1. Input and Output Waveforms, Noninverting Input Varied

affecting comparator operation. Likewise, do not three-state \overline{SHDN} . Due to the output leakage currents of three-state devices and the small internal current for \overline{SHDN} , three-stating this pin could also result in indeterminate logic levels.

The maximum input voltage for \overline{SHDN} is 6V, referred to GND, and is not limited by V_{CC} . This allows the use of 5V logic to drive \overline{SHDN} while V_{CC} operates at a lower voltage, such as 3V. The logic threshold limits for \overline{SHDN} are proportional to V_{CC} (see *Electrical Characteristics*).

Applications Information

Circuit Layout and Bypassing

The MAX976/MAX978/MAX998 have a high-gain bandwidth and require careful board layout. We recommend the following design guidelines:

- 1) Use a printed circuit board with an unbroken, low-inductance ground plane. Surface-mount components are recommended.
- 2) Place a decoupling capacitor (a 0.1 μ F ceramic capacitor is a good choice) between V_{CC} and ground as close to the pins as possible.
- 3) Keep lead lengths short on the inputs and outputs to avoid unwanted parasitic feedback around the comparators.
- 4) Solder the devices directly to the printed circuit board instead of using a socket.
- 5) Minimize input impedance.
- 6) For slowly varying inputs, use a small capacitor (~1000pF) across the inputs to improve stability.

Additional Hysteresis

Generate additional hysteresis with three resistors using positive feedback, as shown in Figure 2. This positive feedback method slows the hysteresis response time. Calculate resistor values as follows:

- 1) Select R3. The leakage current of IN+ is typically 75nA, so the current through R3 should be at least 1.0 μ A to minimize errors caused by leakage current. The current through R3 at the trip point is $(V_{REF} - V_{OUT}) / R3$. Consider the two possible output states when solving for R3. The two formulas are:

$$R3 = V_{REF}/1.0\mu A$$

or

$$R3 = (V_{CC} - V_{REF})/1.0\mu A$$

Use the smaller of the two resulting resistor values. For example, if $V_{REF} = 1.2V$ and $V_{CC} = 5.0V$, the two resistor values are 1.2M Ω and 3.8M Ω . Choose a standard value for R3 of 1.2M Ω .

MAX976/MAX978/MAX998

Single/Dual/Quad, SOT23, Single-Supply, High-Speed, Low-Power Comparators



Figure 2. Additional Hysteresis

- Choose the hysteresis band required (V_{HB}). For this example, choose 100mV.
- Calculate R1. $R1 = R3 \times (V_{HB} / V_{CC})$. Plugging in the values for this example,

$$R1 = 1.2M\Omega \times (100mV / 5.0V) = 24k\Omega$$

- Choose the trip point for V_{IN} rising. This is the threshold voltage at which the comparator switches from low to high as V_{IN} rises above the trip point. In this example, choose 3.0V.
- Calculate R2 as follows:

$$R2 = \frac{1}{\left(\frac{V_{THR}}{V_{REF} \times R1}\right) - \frac{1}{R1} - \frac{1}{R3}}$$

$$R2 = \frac{1}{\left(\frac{3.0V}{1.2 \times 24k\Omega}\right) - \frac{1}{24k\Omega} - \frac{1}{1.2M}} = 16.2k\Omega$$

Choose a standard value for R2 of 16k Ω .

- Verify the trip voltage and hysteresis as follows:

$$V_{IN} \text{ rising: } V_{THR} = V_{REF} \times R1 \times \left(\frac{1}{R1} + \frac{1}{R2} + \frac{1}{R3}\right)$$

$$V_{IN} \text{ falling: } V_{THF} = V_{THR} - \left(\frac{R1 \times V_{CC}}{R3}\right)$$

$$\text{Hysteresis} = V_{THR} - V_{THF}$$

IR Receiver

The *Typical Operating Circuit* shows an application using the MAX998 as an infrared receiver. The infrared photodiode creates a current relative to the amount of infrared light present. This current creates a voltage across R_D . When this voltage level crosses the voltage applied by the voltage divider to the inverting input, the output transitions.

Window Comparator

The MAX976 is ideal for making a window detector (undervoltage/overvoltage detector). The schematic shown in Figure 3 uses a MAX6120 reference and component values selected for a 2.0V undervoltage threshold and a 2.5V overvoltage threshold. Choosing different thresholds by changing the values of R1, R2, and R3. OUTA provides an active-low undervoltage indication, and OUTB gives an active-low overvoltage indication. ANDing the two outputs provides an active-high, power-good signal. The design procedure is as follows:

- Select R1. The leakage current into INB- is normally 75nA, so the current through R1 should exceed 1.0 μ A for the thresholds to be accurate. R1 values in the 50k Ω to 100k Ω range are typical.
- Choose the overvoltage threshold (V_{OTH}) when V_{IN} is rising, and calculate R2 and R3 with the following formula:

$$R_{SUM} = R2 + R3 = R1 \times [V_{OTH} / (V_{REF} + V_H) - 1]$$

where $V_H = 1/2V_{HYST}$.

- Choose the undervoltage threshold (V_{UTH}) when V_{IN} is falling, and calculate R2 with the following formula:

$$R2 = (R1 + R_{SUM}) \times [(V_{REF} - V_H) / V_{UTH}] - R1$$

where $V_H = 1/2V_{HYST}$.

- Calculate R3 with the following formula:

$$R3 = (R_{SUM}) - R2$$

- Verify the resistor values. The equations are as follows:

$$V_{OTH} = (V_{REF} + V_H) \times (R1 + R2 + R3) / R1$$

$$V_{UTH} = (V_{REF} - V_H) \times (R1 + R2 + R3) / (R1 + R2)$$

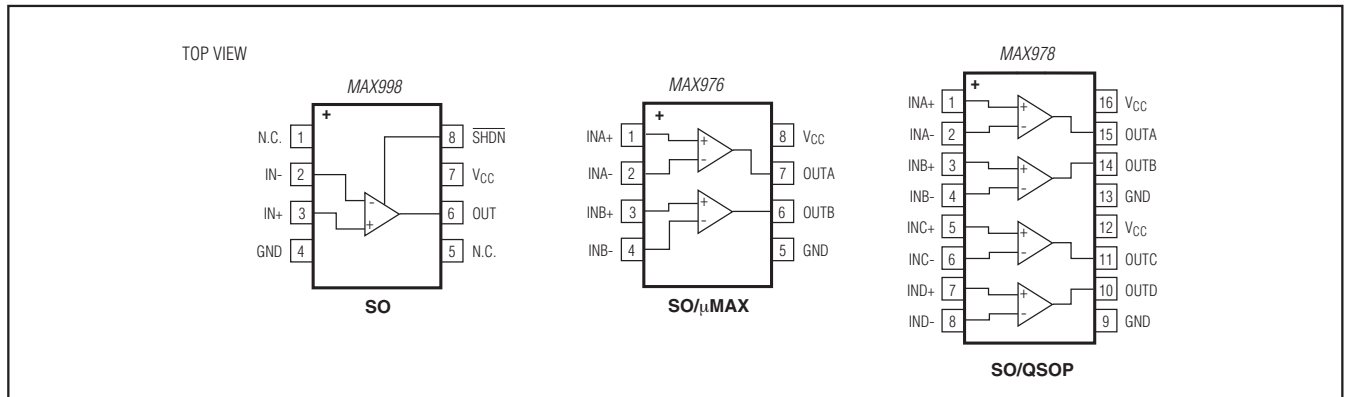

Figure 3. Window Comparator

MAX976/MAX978/MAX998

Single/Dual/Quad, SOT23, Single-Supply, High-Speed, Low-Power Comparators

Pin Configurations (continued)



Chip Information

PROCESS: CMOS

MAX976/MAX978/MAX998

Single/Dual/Quad, SOT23, Single-Supply, High-Speed, Low-Power Comparators

Package Information

For the latest package outline information and land patterns (footprints), go to www.maximintegrated.com/packages. Note that a "+", "#", or "-" in the package code indicates RoHS status only. Package drawings may show a different suffix character, but the drawing pertains to the package regardless of RoHS status.

PACKAGE TYPE	PACKAGE CODE	OUTLINE NO.	LAND PATTERN NO.
6 SOT23	U6+2	21-0058	90-0175
8 SO	S8+2	21-0041	90-0096
8 μ MAX	U8+1	21-0036	90-0092
16 SO	S16M+3	21-0041	90-0097
16 QSOP	E16M+1	21-0055	90-0167

MAX976/MAX978/MAX998

Single/Dual/Quad, SOT23, Single-Supply, High-Speed, Low-Power Comparators

Revision History

REVISION NUMBER	REVISION DATE	DESCRIPTION	PAGES CHANGED
0	10/97	Initial release	—
1	1/98	Adding specs for MAX998	—
2	1/07	Adding input current ratings to Abs Max	—
3	3/09	Update <i>Chip Information</i> , Package Info, correct unit measurement in TOC 8, style changes	1, 3, 4, 8
4	5/14	Added lead-free information to <i>Ordering Information</i> , revised <i>Absolute Maximum Ratings</i> and <i>Package Information</i>	1, 2, 9



Maxim Integrated cannot assume responsibility for use of any circuitry other than circuitry entirely embodied in a Maxim Integrated product. No circuit patent licenses are implied. Maxim Integrated reserves the right to change the circuitry and specifications without notice at any time. The parametric values (min and max limits) shown in the Electrical Characteristics table are guaranteed. Other parametric values quoted in this data sheet are provided for guidance.

Mouser Electronics

Authorized Distributor

Click to View Pricing, Inventory, Delivery & Lifecycle Information:

Maxim Integrated:

[MAX976ESA+](#) [MAX976EUA+](#) [MAX998ESA+](#) [MAX998EUT+T](#) [MAX976ESA+T](#) [MAX976EUA+T](#) [MAX978EEE+](#)
[MAX978EEE+T](#) [MAX978ESE+](#) [MAX978ESE+T](#) [MAX998ESA+T](#) [MAX998EUT-T](#) [MAX976ESA](#) [MAX976ESA-T](#)
[MAX976EUA](#) [MAX976EUA-T](#) [MAX998ESA](#) [MAX998ESA-T](#) [MAX978EEE](#) [MAX978EEE-T](#)