

# IRF7862PbF

HEXFET® Power MOSFET

## Applications

- Synchronous MOSFET for Notebook Processor Power
- Synchronous Rectifier MOSFET for Isolated DC-DC Converters

$V_{DSS}$	$R_{DS(on) \text{ max}}$	$Q_g$
30V	$3.3\text{m}\Omega @ V_{GS} = 10\text{V}$	30nC

## Benefits

- Very Low  $R_{DS(on)}$  at 4.5V  $V_{GS}$
- Ultra-Low Gate Impedance
- Fully Characterized Avalanche Voltage and Current
- 20V  $V_{GS}$  Max. Gate Rating
- 100% tested for Rg
- Lead-Free

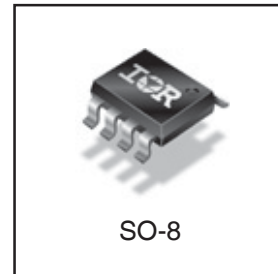
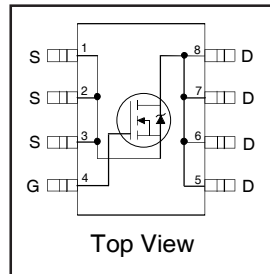

## Absolute Maximum Ratings

	Parameter	Max.	Units
$V_{DS}$	Drain-to-Source Voltage	30	V
$V_{GS}$	Gate-to-Source Voltage	$\pm 20$	
$I_D @ T_A = 25^\circ\text{C}$	Continuous Drain Current, $V_{GS} @ 10\text{V}$	21	A
$I_D @ T_A = 70^\circ\text{C}$	Continuous Drain Current, $V_{GS} @ 10\text{V}$	17	
$I_{DM}$	Pulsed Drain Current ①	170	
$P_D @ T_A = 25^\circ\text{C}$	Power Dissipation	2.5	W
$P_D @ T_A = 70^\circ\text{C}$	Power Dissipation	1.6	
	Linear Derating Factor	0.02	W/ $^\circ\text{C}$
$T_J$	Operating Junction and	-55 to + 150	$^\circ\text{C}$
$T_{STG}$	Storage Temperature Range		

## Thermal Resistance

	Parameter	Typ.	Max.	Units
$R_{\theta JL}$	Junction-to-Drain Lead ⑤	—	20	$^\circ\text{C}/\text{W}$
$R_{\theta JA}$	Junction-to-Ambient ④	—	50	

Notes ① through ⑤ are on page 9

## Static @ T<sub>J</sub> = 25°C (unless otherwise specified)

	Parameter	Min.	Typ.	Max.	Units	Conditions
BV <sub>DSS</sub>	Drain-to-Source Breakdown Voltage	30	—	—	V	V <sub>GS</sub> = 0V, I <sub>D</sub> = 250μA
ΔBV <sub>DSS</sub> /ΔT <sub>J</sub>	Breakdown Voltage Temp. Coefficient	—	0.023	—	V/°C	Reference to 25°C, I <sub>D</sub> = 1mA
R <sub>DS(on)</sub>	Static Drain-to-Source On-Resistance	—	3.0	3.3	mΩ	V <sub>GS</sub> = 10V, I <sub>D</sub> = 20A ③
		—	3.7	4.5		V <sub>GS</sub> = 4.5V, I <sub>D</sub> = 16A ③
V <sub>GS(th)</sub>	Gate Threshold Voltage	1.35	—	2.35	V	V <sub>DS</sub> = V <sub>GS</sub> , I <sub>D</sub> = 100μA
ΔV <sub>GS(th)</sub>	Gate Threshold Voltage Coefficient	—	-5.4	—	mV/°C	V <sub>DS</sub> = V <sub>GS</sub> , I <sub>D</sub> = 250μA
I <sub>DSS</sub>	Drain-to-Source Leakage Current	—	—	1.0	μA	V <sub>DS</sub> = 24V, V <sub>GS</sub> = 0V
		—	—	150		V <sub>DS</sub> = 24V, V <sub>GS</sub> = 0V, T <sub>J</sub> = 125°C
I <sub>GSS</sub>	Gate-to-Source Forward Leakage	—	—	100	nA	V <sub>GS</sub> = 20V
	Gate-to-Source Reverse Leakage	—	—	-100		V <sub>GS</sub> = -20V
gfs	Forward Transconductance	87	—	—	S	V <sub>DS</sub> = 15V, I <sub>D</sub> = 16A
Q <sub>g</sub>	Total Gate Charge	—	30	45	nC	V <sub>DS</sub> = 15V V <sub>GS</sub> = 4.5V I <sub>D</sub> = 16A See Figs. 15 & 16
Q <sub>gs1</sub>	Pre-V <sub>th</sub> Gate-to-Source Charge	—	7.5	—		
Q <sub>gs2</sub>	Post-V <sub>th</sub> Gate-to-Source Charge	—	3.1	—		
Q <sub>gd</sub>	Gate-to-Drain Charge	—	9.8	—		
Q <sub>godr</sub>	Gate Charge Overdrive	—	9.6	—		
Q <sub>sw</sub>	Switch Charge (Q <sub>gs2</sub> + Q <sub>gd</sub> )	—	12.9	—		
Q <sub>oss</sub>	Output Charge	—	18	—	nC	V <sub>DS</sub> = 16V, V <sub>GS</sub> = 0V
R <sub>g</sub>	Gate Resistance	—	1.0	1.6	Ω	
t <sub>d(on)</sub>	Turn-On Delay Time	—	16	—	ns	V <sub>DD</sub> = 15V, V <sub>GS</sub> = 4.5V I <sub>D</sub> = 16A R <sub>G</sub> = 1.8Ω See Fig. 18
t <sub>r</sub>	Rise Time	—	19	—		
t <sub>d(off)</sub>	Turn-Off Delay Time	—	18	—		
t <sub>f</sub>	Fall Time	—	11	—		
C <sub>iss</sub>	Input Capacitance	—	4090	—	pF	V <sub>GS</sub> = 0V V <sub>DS</sub> = 15V f = 1.0MHz
C <sub>oss</sub>	Output Capacitance	—	810	—		
C <sub>riss</sub>	Reverse Transfer Capacitance	—	390	—		

## Avalanche Characteristics

	Parameter	Typ.	Max.	Units
E <sub>AS</sub>	Single Pulse Avalanche Energy ②	—	350	mJ
I <sub>AR</sub>	Avalanche Current ①	—	16	A

## Diode Characteristics

	Parameter	Min.	Typ.	Max.	Units	Conditions
I <sub>S</sub>	Continuous Source Current (Body Diode)	—	—	3.1	A	MOSFET symbol showing the integral reverse p-n junction diode.
I <sub>SM</sub>	Pulsed Source Current (Body Diode) ①	—	—	170		
V <sub>SD</sub>	Diode Forward Voltage	—	—	1.0	V	T <sub>J</sub> = 25°C, I <sub>S</sub> = 16A, V <sub>GS</sub> = 0V ③
t <sub>rr</sub>	Reverse Recovery Time	—	17	26	ns	T <sub>J</sub> = 25°C, I <sub>F</sub> = 16A, V <sub>DD</sub> = 15V
Q <sub>rr</sub>	Reverse Recovery Charge	—	33	50	nC	di/dt = 430A/μs ③
t <sub>on</sub>	Forward Turn-On Time	Intrinsic turn-on time is negligible (turn-on is dominated by LS+LD)				

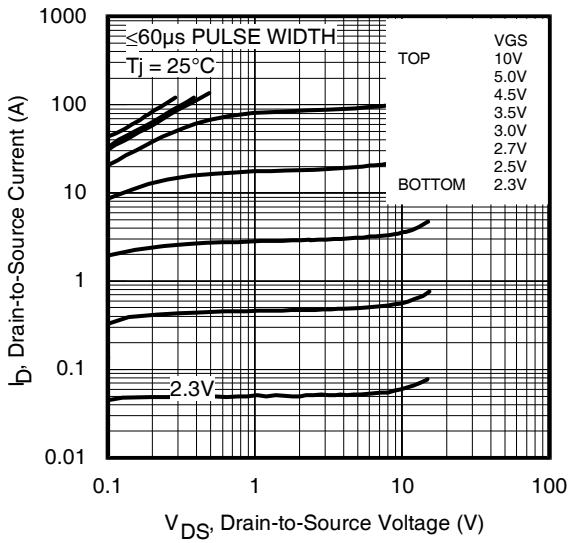

**Fig 1.** Typical Output Characteristics

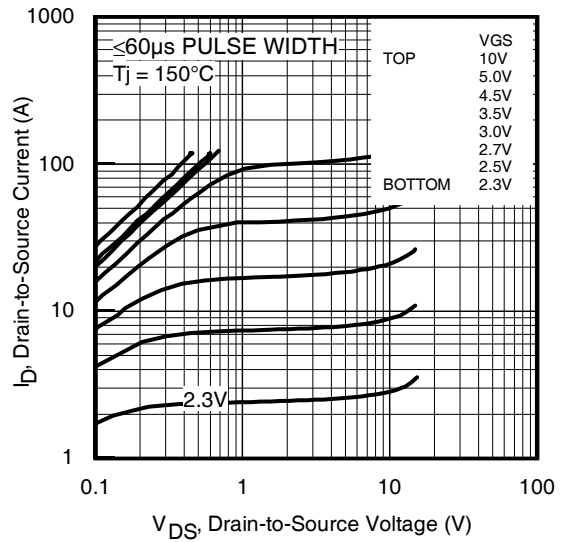

**Fig 2.** Typical Output Characteristics

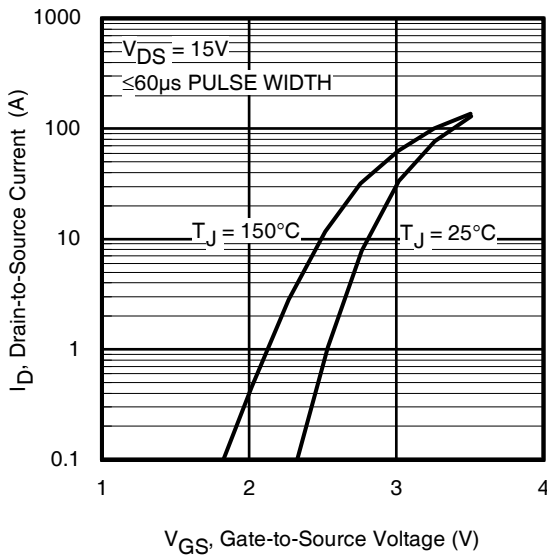

**Fig 3.** Typical Transfer Characteristics

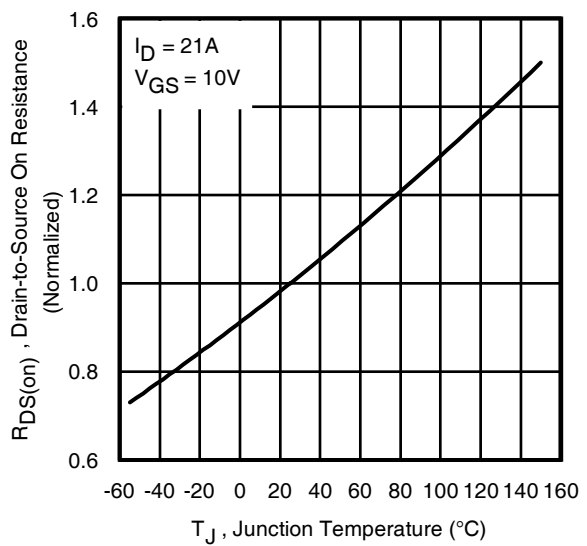

**Fig 4.** Normalized On-Resistance vs. Temperature

# IRF7862PbF

International  
**IR** Rectifier

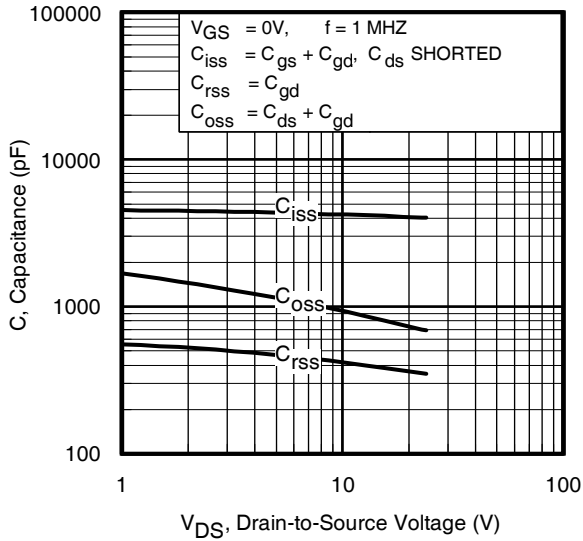

**Fig 5.** Typical Capacitance vs. Drain-to-Source Voltage

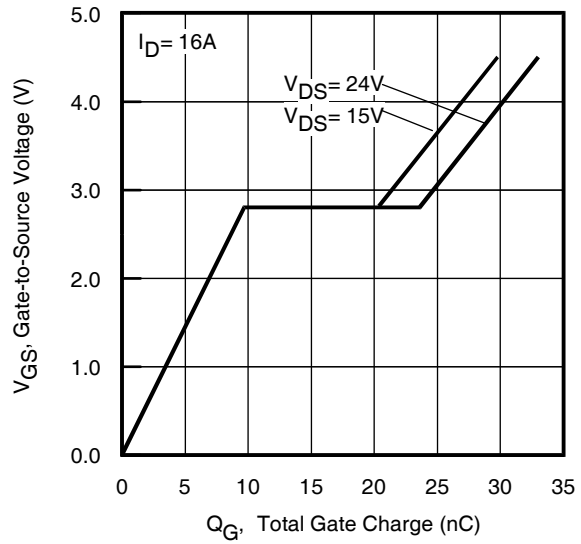

**Fig 6.** Typical Gate Charge Vs. Gate-to-Source Voltage

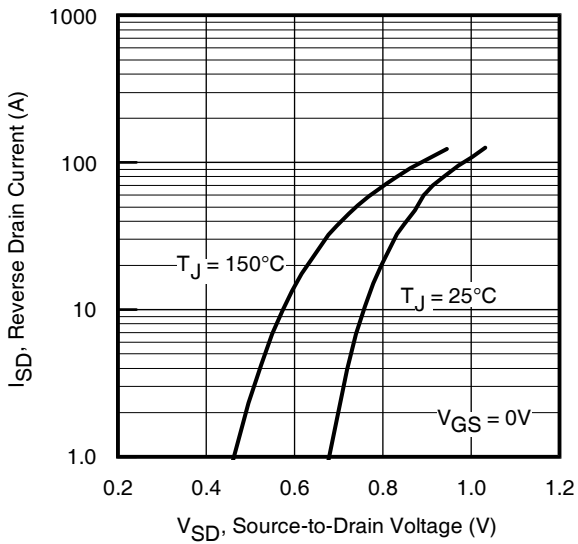

**Fig 7.** Typical Source-Drain Diode Forward Voltage

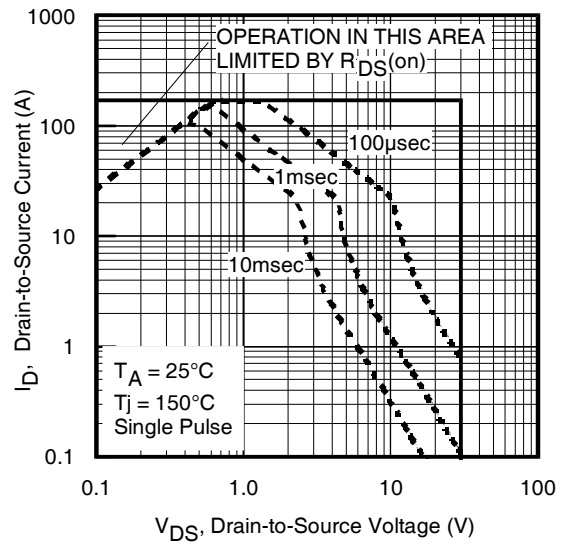

**Fig 8.** Maximum Safe Operating Area

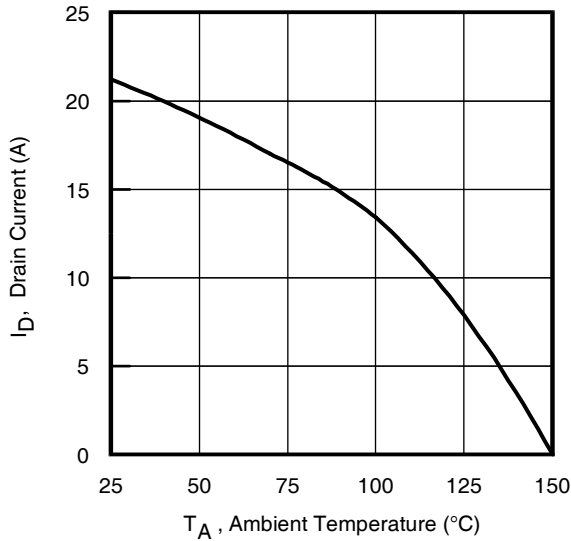

**Fig 9.** Maximum Drain Current vs. Ambient Temperature

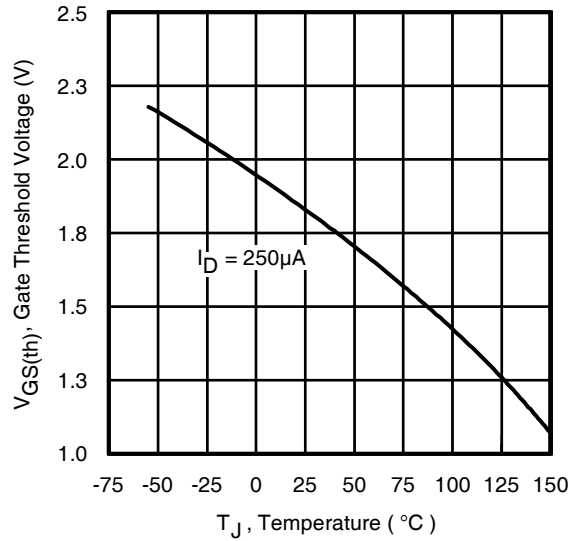

**Fig 10.** Threshold Voltage vs. Temperature

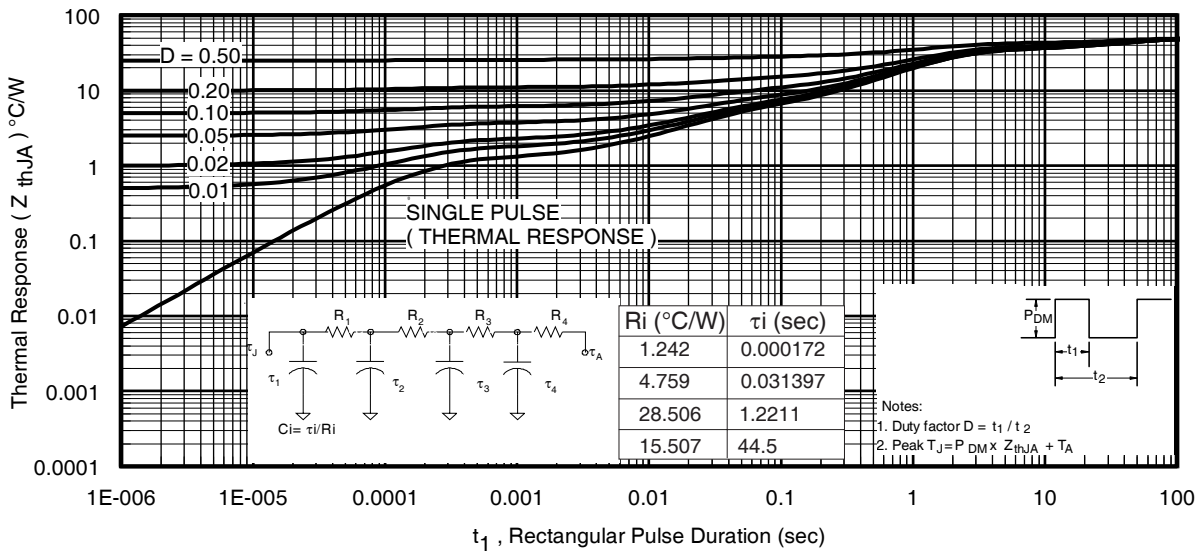

**Fig 11.** Maximum Effective Transient Thermal Impedance, Junction-to-Ambient

# IRF7862PbF

International  
**IR** Rectifier

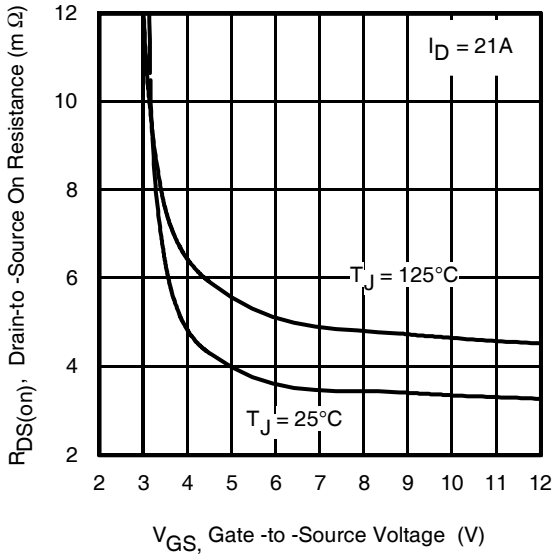

**Fig 12.** On-Resistance vs. Gate Voltage

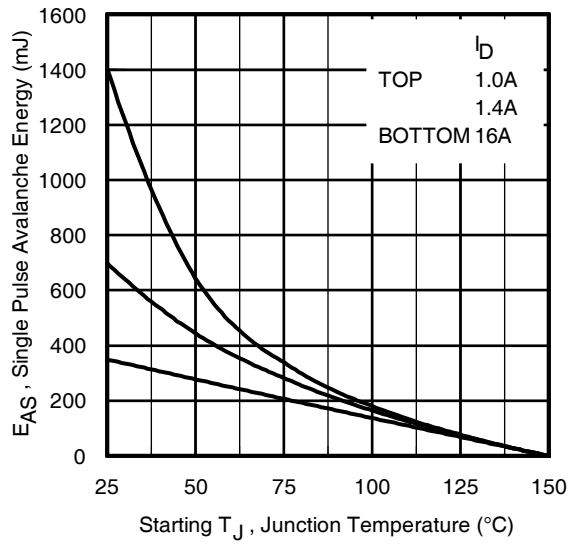

**Fig 13.** Maximum Avalanche Energy vs. Drain Current



**Fig 14.** Unclamped Inductive Test Circuit and Waveform



**Fig 15.** Gate Charge Test Circuit



**Fig 16.** Gate Charge Waveform

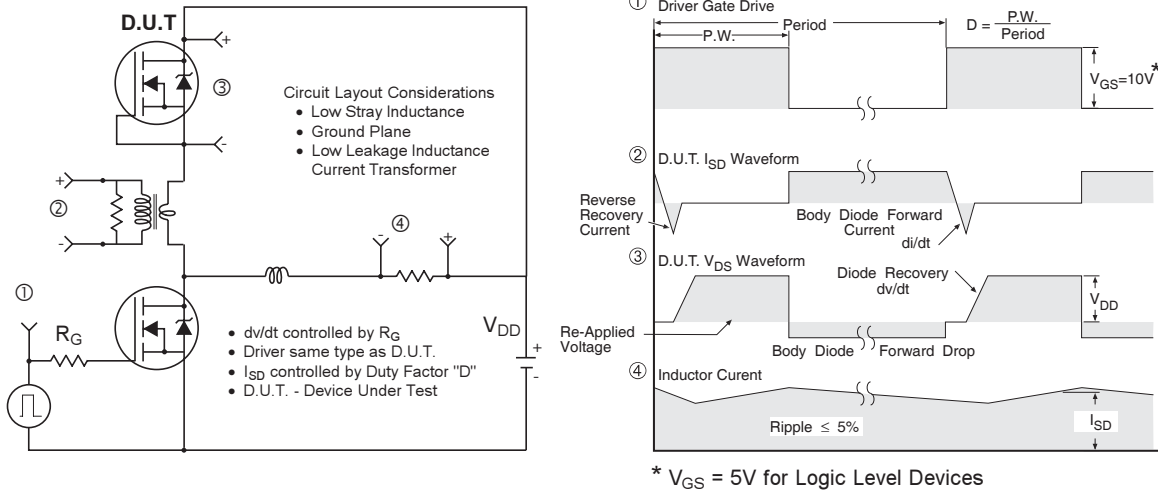

**Fig 17. Peak Diode Recovery  $dv/dt$  Test Circuit for N-Channel HEXFET® Power MOSFETs**

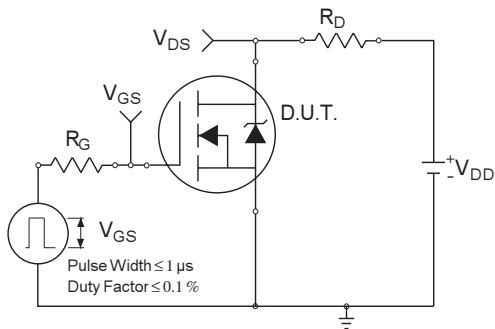

**Fig 18a. Switching Time Test Circuit**

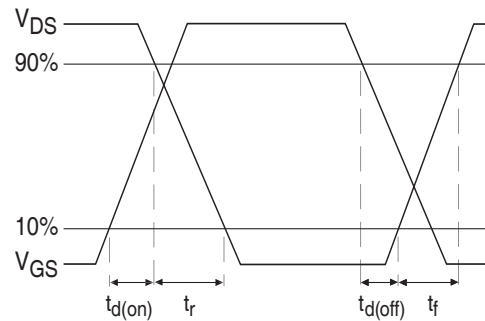

**Fig 18b. Switching Time Waveforms**

# IRF7862PbF

International  
**IR** Rectifier

## SO-8 Package Outline (MOSFET & Fetky)

Dimensions are shown in millimeters (inches)

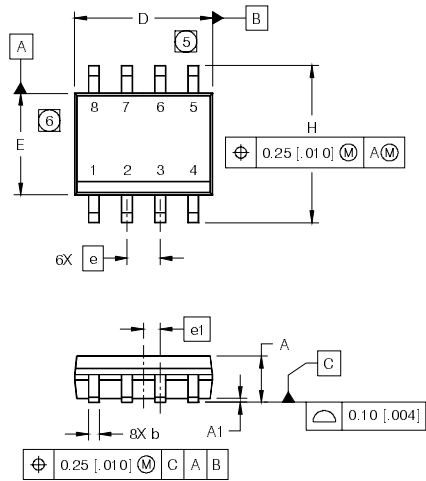

DIM	INCHES		MILLIMETERS	
	MIN	MAX	MIN	MAX
A	.0532	.0688	1.35	1.75
A1	.0040	.0098	0.10	0.25
b	.013	.020	0.33	0.51
c	.0075	.0098	0.19	0.25
D	.189	.1968	4.80	5.00
E	.1497	.1574	3.80	4.00
e	.050 BASIC		1.27 BASIC	
e1	.025 BASIC		0.635 BASIC	
H	.2284	.2440	5.80	6.20
K	.0099	.0196	0.25	0.50
L	.016	.050	0.40	1.27
y	0°	8°	0°	8°

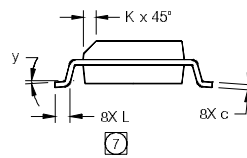

### FOOTPRINT

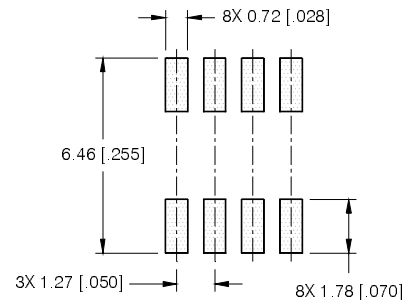

#### NOTES:

1. DIMENSIONING & TOLERANCING PER ASME Y14.5M-1994.
2. CONTROLLING DIMENSION: MILLIMETER
3. DIMENSIONS ARE SHOWN IN MILLIMETERS [INCHES].
4. OUTLINE CONFORMS TO JEDEC OUTLINE MS-012AA.
- ⑤ DIMENSION DOES NOT INCLUDE MOLD PROTRUSIONS. MOLD PROTRUSIONS NOT TO EXCEED 0.15 [0.006].
- ⑥ DIMENSION DOES NOT INCLUDE MOLD PROTRUSIONS. MOLD PROTRUSIONS NOT TO EXCEED 0.25 [0.010].
- ⑦ DIMENSION IS THE LENGTH OF LEAD FOR SOLDERING TO A SUBSTRATE.

## SO-8 Part Marking Information

EXAMPLE: THIS IS AN IRF7101 (MOSFET)

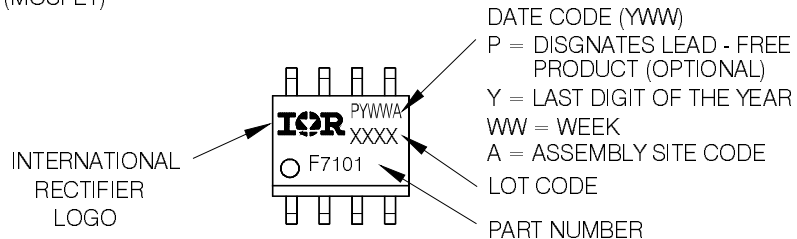

Note: For the most current drawing please refer to IR website at <http://www.irf.com/package/>



## SO-8 Tape and Reel Dimensions are shown in millimeters (inches)

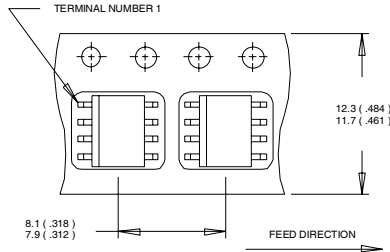

- NOTES:
1. CONTROLLING DIMENSION : MILLIMETER.
  2. ALL DIMENSIONS ARE SHOWN IN MILLIMETERS(INCHES).
  3. OUTLINE CONFORMS TO EIA-481 & EIA-541.

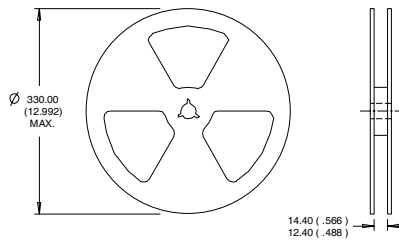

- NOTES:
1. CONTROLLING DIMENSION : MILLIMETER.
  2. OUTLINE CONFORMS TO EIA-481 & EIA-541.

### Notes:

- ① Repetitive rating; pulse width limited by max. junction temperature.
- ② Starting  $T_J = 25^\circ\text{C}$ ,  $L = 2.7\text{mH}$ ,  $R_G = 25\Omega$ ,  $I_{AS} = 16\text{A}$ .
- ③ Pulse width  $\leq 400\mu\text{s}$ ; duty cycle  $\leq 2\%$ .
- ④ When mounted on 1 inch square copper board.
- ⑤  $R_{\theta}$  is measured at  $T_J$  of approximately  $90^\circ\text{C}$ .

### Revision History

Date	Comment
6/4/2009	Maximum $R_{ds(on)}$ at $V_{gs} = 10\text{V}$ changed from $3.7\text{m}\Omega$ to $3.3\text{m}\Omega$ . All other parameters are unchanged.

Note: For the most current drawing please refer to IR website at <http://www.irf.com/package>

Data and specifications subject to change without notice.  
 This product has been designed and qualified for the Consumer market.  
 Qualification Standards can be found on IR's Web site.

# Mouser Electronics

Authorized Distributor

Click to View Pricing, Inventory, Delivery & Lifecycle Information:

[Infineon:](#)

[IRF7862TRPBF](#) [IRF7862PBF](#)