

SMT POWER INDUCTORS

Power Beads - PA0766NL Series



- Two independent inductors integrated into a single package
- Less board space and lower cost than two separate inductors
- Ideal for multi-phase and single phase applications
- **Current Rating:** 76A_{pk}
- **Inductance Range:** 148nH to 1140nH
- **Footprint:** 14.0 x 13.5mm Max
- **Height:** 7.0mm Max

Electrical Specifications @ 25°C — Operating Temperature -40°C to +130°C¹⁰

Dual Phase Integrated Inductor Specifications for Multi-phase Systems²

Part Number	Inductance @I _{rated} (nH TYP)		I _{rated} ⁵ (A _{DC})		DCR/phase ^{2,3} (mΩ)		Inductance ¹ @0A _{DC} (nH ± 20%)		Saturation Current ⁶ (A _{DC})		Heating ⁷ Current (A _{DC})	
	L1	L2	L1	L2	L1	L2	L1	L2	L1	L2	L1	L2
PA0766.281NLT	285	285	26	26	0.75	0.75	296	296	38	38	26	26
PA0766.341NLT	325	325	26	26			352	352	31.5	31.5		
PA0766.421NLT	395	395	25	25			435	435	25	25		
PA0766.561NLT	495	495	18.5	18.5			568	568	18.5	18.5		

Single Phase Inductor Specifications for Series and Parallel Connections¹

Part Number	Inductance @I _{rated} (nH TYP)	I _{rated} ⁵ (A _{DC})	DCR ^{2,3} (mΩ)	Inductance @0A _{DC} ¹ (nH ± 20%)	Saturation Current ⁶ (A _{DC})	Heating Current ⁷ (A _{DC})	Connection
PA0766.281NLT	148	52	0.38	148	76	52	Parallel
PA0766.341NLT	160	52		176	63		
PA0766.421NLT	180	50		218	50		
PA0766.561NLT	240	37		284	37		
PA0766.281NLT	635	26	1.50	592	38	26	Series
PA0766.341NLT	700	26		704	31.5		
PA0766.421NLT	770	25		870	25		
PA0766.561NLT	1000	18.5		1140	18.5		

NOTES:

- Inductance is measured at 500kHz, 100mVrms.
- The **PA0766** consists of two separate and independent inductors integrated into a single package. The two inductors can be used for two separate phases within dual output or multi-phase application or they can be connected in series or parallel to form a single inductor within a single phase application.
- The nominal DCR has a tolerance of ±9%. This tolerance is guaranteed by design, but is not a manufacturing production test. The nominal DCR is measured from point a to point b, as shown below on the mechanical drawing.
- For manufacturing production test, a maximum DCR value of 0.9mΩ per phase is used.
- The rated current as listed is either the saturation current or the heating current depending on which value is lower.
- The saturation current is the current which causes the inductance to drop a maximum of 26% from the nominal inductance at 0A_{DC} at the stated ambient temperatures (25°C). This current is determined by placing the component in the specified ambient environment and applying a short duration pulse current (to eliminate self-heating effects) to the component.
- The heating current is the DC current which causes the part temperature to increase by approximately 40°C. This current is determined by soldering the component on a typical application PCB, and then applying the current to the device for 30 minutes.
- In high volt*time applications, additional heating in the component can occur due to core losses in the inductor which may necessitate derating the current in order to limit the temperature rise of the component. To determine the approximate total losses (or temperature rise) for a given application, the coreloss and temperature rise curves can be used.
- Pulse complies with industry standard tape and reel specification EIA481.
- The temperature of the component (ambient plus temperature rise) must be within the stated operating temperature range.

SMT POWER INDUCTORS

Power Beads - PA0766NL Series



Mechanical

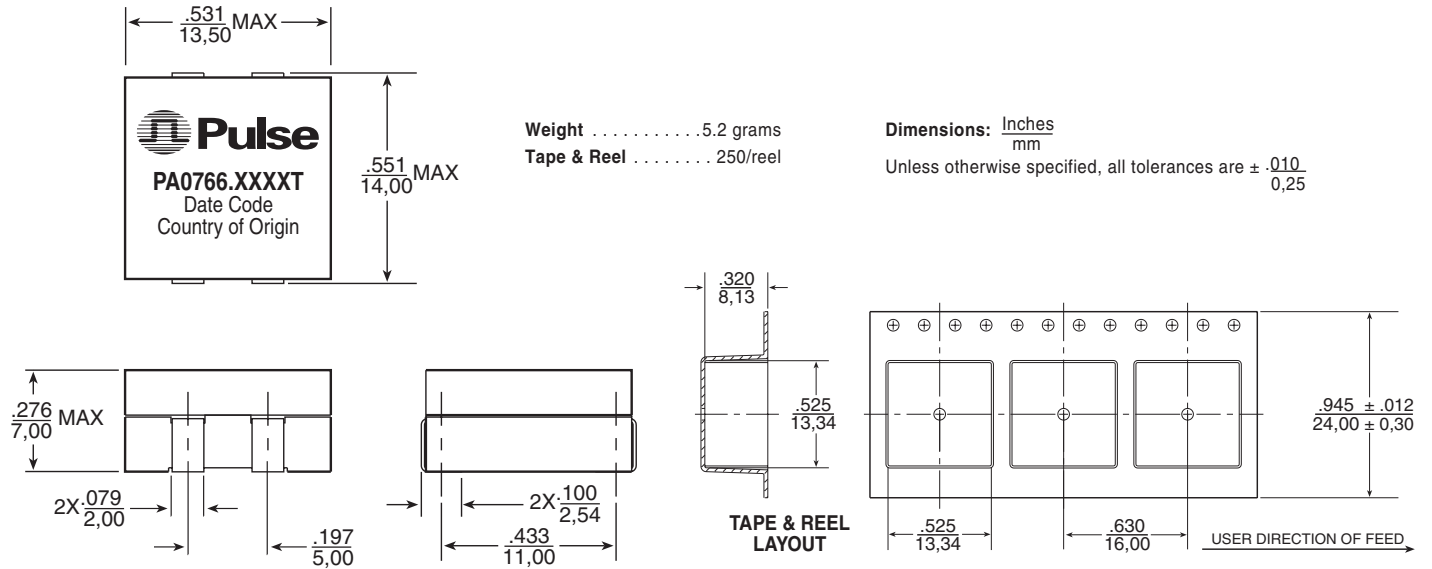

Schematics and Footprints

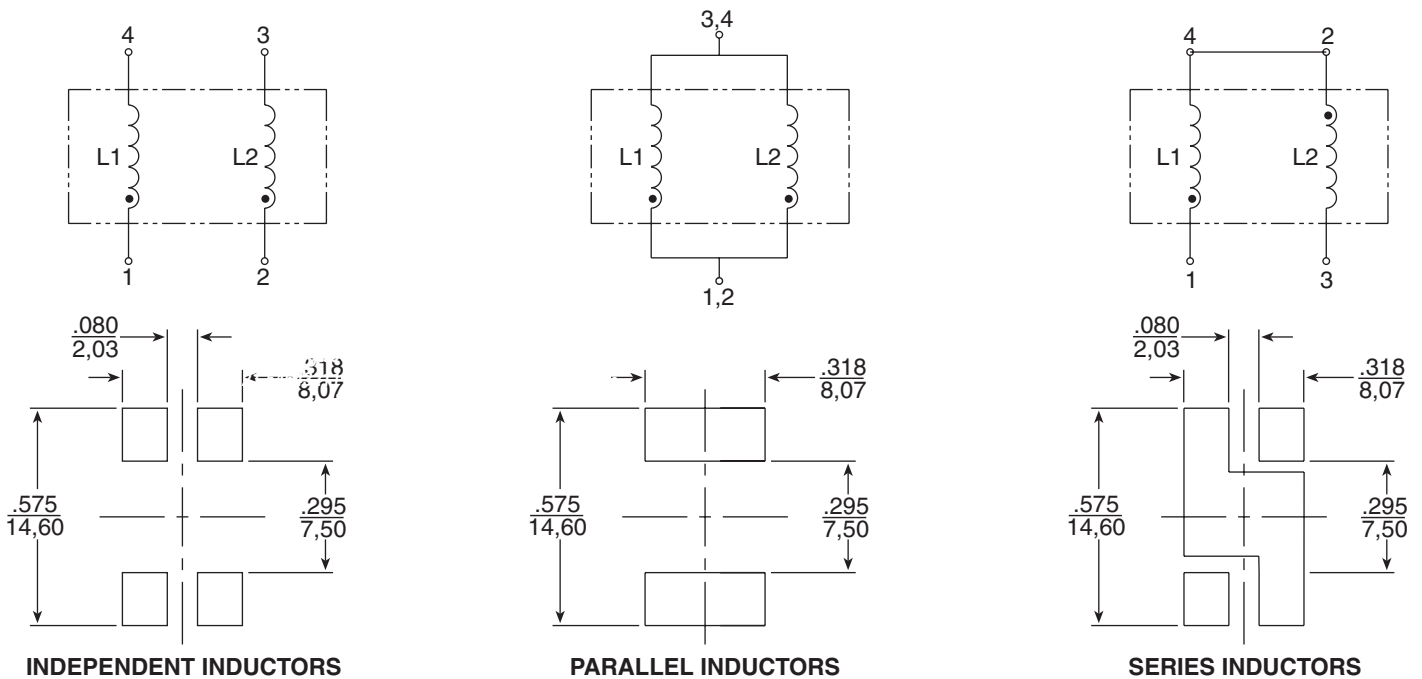

Typical Inductance vs Current

Single Inductor Parallel Connection

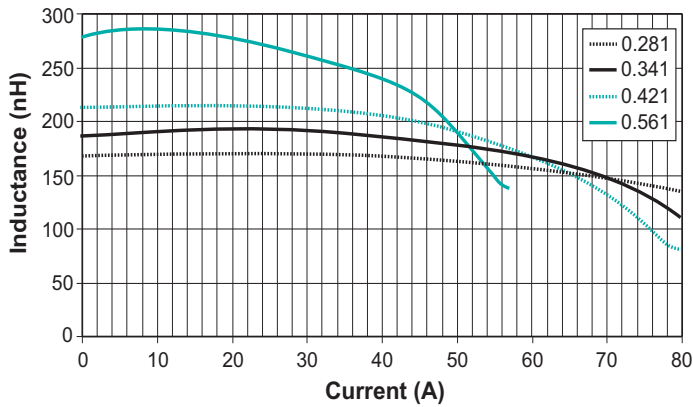

Single Inductor Series Connection

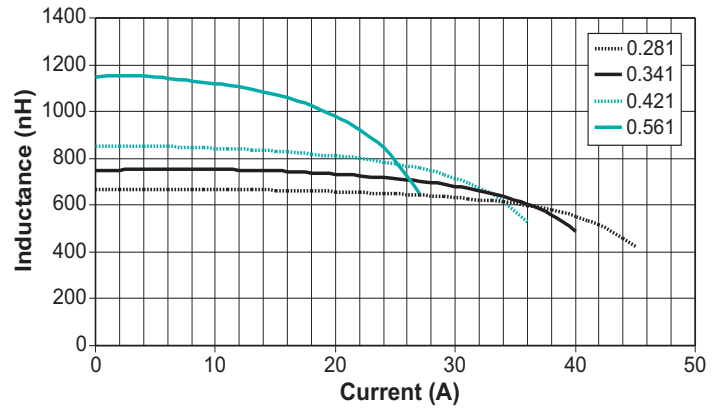

Two Independant Inductors

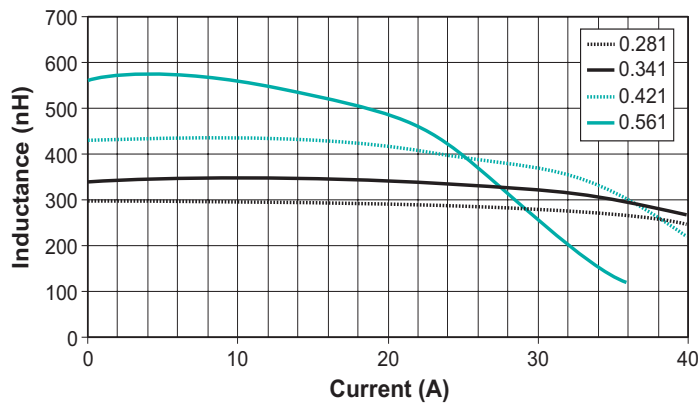

CoreLoss vs Flux Density

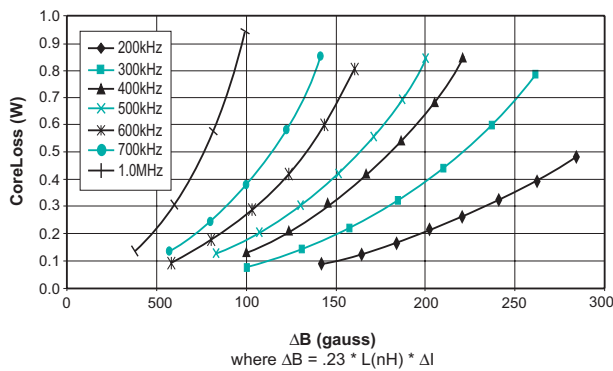

Temp Rise vs Power Dissipation

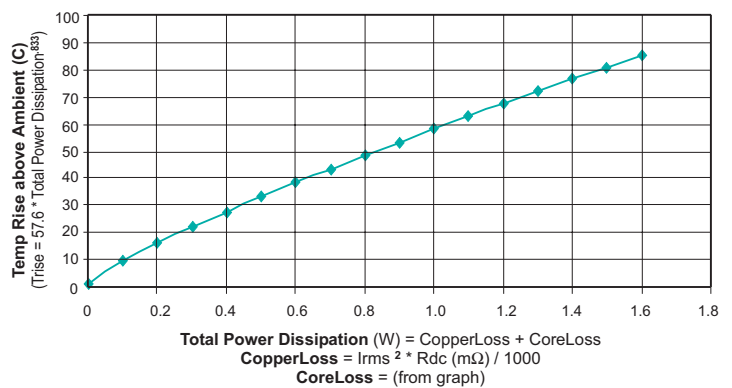

NOTE: When inductors are used as two independant inductors in multi-phase applications, the copper loss in both phases needs to be calculated.

Mouser Electronics

Authorized Distributor

Click to View Pricing, Inventory, Delivery & Lifecycle Information:

Pulse:

[PA0766.281NLT](#) [PA0766.561NLT](#) [PA0766.341NLT](#) [PA0766.421NLT](#)