

# TPS736xx Cap-Free, NMOS, 400-mA Low-Dropout Regulator with Reverse Current Protection

## 1 Features

- Stable with No Output Capacitor or Any Value or Type of Capacitor
- Input Voltage Range of 1.7 V to 5.5 V
- Ultra-Low Dropout Voltage: 75 mV typ
- Excellent Load Transient Response—with or without Optional Output Capacitor
- New NMOS Topology Delivers Low Reverse Leakage Current
- Low Noise: 30  $\mu\text{V}_{\text{RMS}}$  typ (10 Hz to 100 kHz)
- 0.5% Initial Accuracy
- 1% Overall Accuracy Over Line, Load, and Temperature
- Less Than 1  $\mu\text{A}$  max  $I_{\text{Q}}$  in Shutdown Mode
- Thermal Shutdown and Specified Min/Max Current Limit Protection
- Available in Multiple Output Voltage Versions
  - Fixed Outputs of 1.20 V to 5.0 V
  - Adjustable Output from 1.20 V to 5.5 V
  - Custom Outputs Available

## 2 Applications

- Portable/Battery-Powered Equipment
- Post-Regulation for Switching Supplies
- Noise-Sensitive Circuitry such as VCOs
- Point of Load Regulation for DSPs, FPGAs, ASICs, and Microprocessors

## 3 Description

The TPS736xx family of low-dropout (LDO) linear voltage regulators uses a new topology: an NMOS pass element in a voltage-follower configuration. This topology is stable using output capacitors with low ESR, and even allows operation without a capacitor. It also provides high reverse blockage (low reverse current) and ground pin current that is nearly constant over all values of output current.

The TPS736xx uses an advanced BiCMOS process to yield high precision while delivering very low dropout voltages and low ground pin current. Current consumption, when not enabled, is under 1  $\mu\text{A}$  and ideal for portable applications. The extremely low output noise (30  $\mu\text{V}_{\text{RMS}}$  with 0.1- $\mu\text{F}$   $C_{\text{NR}}$ ) is ideal for powering VCOs. These devices are protected by thermal shutdown and foldback current limit.

### Device Information<sup>(1)</sup>

PART NUMBER	PACKAGE	BODY SIZE (NOM)
TPS736xx	SOT-23 (5)	2.90 mm x 1.60 mm
	SOT-223 (6)	6.50 mm x 3.50 mm
	VSON (8)	3.00 mm x 3.00 mm

(1) For all available packages, see the orderable addendum at the end of the datasheet.

### Typical Application Circuit for Fixed-Voltage Versions

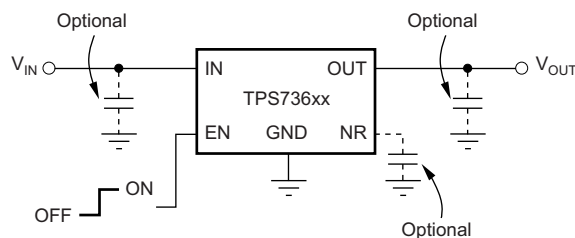

## Table of Contents

<b>1 Features</b> ..... 1 <b>2 Applications</b> ..... 1 <b>3 Description</b> ..... 1 <b>4 Revision History</b> ..... 2 <b>5 Pin Configuration and Functions</b> ..... 3 <b>6 Specifications</b> ..... 4 6.1 Absolute Maximum Ratings ..... 4 6.2 ESD Ratings ..... 4 6.3 Recommended Operating Conditions ..... 4 6.4 Thermal Information ..... 5 6.5 Electrical Characteristics ..... 6 6.6 Typical Characteristics ..... 7 <b>7 Detailed Description</b> ..... 12 7.1 Overview ..... 12 7.2 Functional Block Diagram ..... 12 7.3 Feature Description ..... 13 7.4 Device Functional Modes ..... 14	<b>8 Application and Implementation</b> ..... 15 8.1 Application Information ..... 15 8.2 Typical Applications ..... 15 <b>9 Power Supply Recommendations</b> ..... 20 <b>10 Layout</b> ..... 20 10.1 Layout Guidelines ..... 20 10.2 Layout Examples ..... 20 10.3 Power Dissipation ..... 21 10.4 Thermal Protection ..... 22 10.5 Package Mounting ..... 22 <b>11 Device and Documentation Support</b> ..... 23 11.1 Device Support ..... 23 11.2 Documentation Support ..... 23 11.3 Trademarks ..... 23 11.4 Electrostatic Discharge Caution ..... 23 11.5 Glossary ..... 23 <b>12 Mechanical, Packaging, and Orderable Information</b> ..... 23
---	---

## 4 Revision History

NOTE: Page numbers for previous revisions may differ from page numbers in the current version.

<b>Changes from Revision T (August 2010) to Revision U</b>	<b>Page</b>
• Added <i>ESD Ratings</i> table, <i>Feature Description</i> section, <i>Device Functional Modes</i> , <i>Application and Implementation</i> section, <i>Power Supply Recommendations</i> section, <i>Layout</i> section, <i>Device and Documentation Support</i> section, and <i>Mechanical, Packaging, and Orderable Information</i> section .....	1
• Changed "free-air temperature" to "junction temperature" in <i>Absolute Maximum Ratings</i> condition statement .....	4
• Changed "free-air temperature" to "junction temperature" in <i>Recommended Operating Conditions</i> condition statement .....	4
• Changed <i>Thermal Information</i> table; updated thermal resistance values for all packages .....	5

<b>Changes from Revision S (August, 2009) to Revision T</b>	<b>Page</b>
• Replaced <i>Dissipation Ratings</i> Table with <i>Thermal Information</i> Table.....	4

<b>Changes from Revision R (May, 2008) to Revision S</b>	<b>Page</b>
• Changed <a href="#">Figure 10</a> .....	7
• Added paragraph about recommended start-up sequence to <i>Internal Current Limit</i> section .....	14
• Added paragraph about current foldback and device start-up to <i>Enable Pin and Shutdown</i> section .....	14

## 5 Pin Configuration and Functions

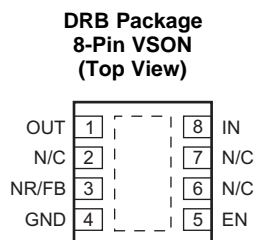
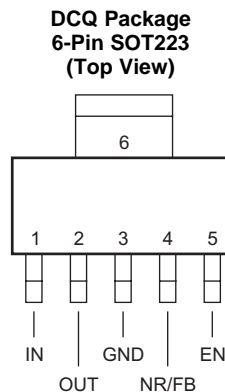
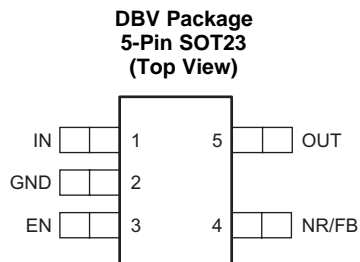

### Pin Functions

NAME	PIN			I/O	DESCRIPTION
	SOT23	SOT223	VSON		
IN	1	1	8	I	Input supply
GND	2	3, 6	4, Pad	—	Ground
EN	3	5	5	I	Driving the enable pin (EN) high turns on the regulator. Driving this pin low puts the regulator into shutdown mode. Refer to the <a href="#">Shutdown</a> section for more details. EN can be connected to IN if not used.
NR	4	4	3	—	Fixed-voltage versions only. Connecting an external capacitor to this noise reduction pin bypasses noise generated by the internal bandgap, reducing output noise to very low levels.
FB	4	4	3	I	Adjustable-voltage version only. This pin is the input to the control loop error amplifier, and sets the output voltage of the device.
OUT	5	2	1	O	Output of the regulator. There are no output capacitor requirements for stability.

## 6 Specifications

### 6.1 Absolute Maximum Ratings

 over operating junction temperature range (unless otherwise noted) <sup>(1)</sup>

		MIN	MAX	UNIT
Voltage	V <sub>IN</sub>	-0.3	+6.0	V
	V <sub>EN</sub>	-0.3	+6.0	V
	V <sub>OUT</sub>	-0.3	+5.5	V
	V <sub>NR</sub> , V <sub>FB</sub>	-0.3	+6.0	V
Peak output current	I <sub>OUT</sub>	Internally limited		
Output short-circuit duration		Indefinite		
Continuous total power dissipation	P <sub>DISS</sub>	See <a href="#">Thermal Information</a>		
T <sub>J</sub>	Junction temperature range	-55	150	°C
T <sub>stg</sub>	Storage temperature range	-65	150	°C

- (1) Stresses beyond those listed under *Absolute Maximum Ratings* may cause permanent damage to the device. These are stress ratings only, which do not imply functional operation of the device at these or any other conditions beyond those indicated under *Recommended Operating Conditions*. Exposure to absolute-maximum-rated conditions for extended periods may affect device reliability. [Electrical Characteristics](#) Exposure to absolute maximum rated conditions for extended periods may affect device reliability

### 6.2 ESD Ratings

		VALUE	UNIT
V <sub>(ESD)</sub>	Electrostatic discharge	Human body model (HBM), per ANSI/ESDA/JEDEC JS-001, all pins <sup>(1)</sup>	±2000
		Charged device model (CDM), per JEDEC specification JESD22-C101, all pins <sup>(2)</sup>	±500

- (1) JEDEC document JEP155 states that 500-V HBM allows safe manufacturing with a standard ESD control process.  
 (2) JEDEC document JEP157 states that 250-V CDM allows safe manufacturing with a standard ESD control process.

### 6.3 Recommended Operating Conditions

over operating junction temperature range (unless otherwise noted)

		MIN	NOM	MAX	UNIT
V <sub>IN</sub>	Input supply voltage range	1.7		5.5	V
I <sub>OUT</sub>	Output current	0		500	mA
T <sub>J</sub>	Operating junction temperature	-40		125	°C

## 6.4 Thermal Information

THERMAL METRIC <sup>(1)(2)</sup>		TPS736 <sup>(3)</sup>			UNIT
		DRB/SON	DCQ/SOT223	DBV/SOT23	
		8 PINS	6 PINS	5 PINS	
$R_{\theta JA}$	Junction-to-ambient thermal resistance <sup>(4)</sup>	52.8	118.7	221.9	°C/W
$R_{\theta JC(top)}$	Junction-to-case (top) thermal resistance <sup>(5)</sup>	60.4	64.9	74.9	
$R_{\theta JB}$	Junction-to-board thermal resistance <sup>(6)</sup>	28.4	65.0	51.9	
$\psi_{JT}$	Junction-to-top characterization parameter <sup>(7)</sup>	2.1	14.0	2.8	
$\psi_{JB}$	Junction-to-board characterization parameter <sup>(8)</sup>	28.6	63.8	51.1	
$R_{\theta JC(bot)}$	Junction-to-case (bottom) thermal resistance <sup>(9)</sup>	12.0	N/A	N/A	

- (1) For more information about traditional and new thermal metrics, see the *IC Package Thermal Metrics* application report, [SPRA953](#).
- (2) For thermal estimates of this device based on PCB copper area, see the [TI PCB Thermal Calculator](#).
- (3) Thermal data for the DRB, DCQ, and DRV packages are derived by thermal simulations based on JEDEC-standard methodology as specified in the JESD51 series. The following assumptions are used in the simulations:
  - (a) i. DRB: The exposed pad is connected to the PCB ground layer through a 2x2 thermal via array.
  - ii. DCQ: The exposed pad is connected to the PCB ground layer through a 3x2 thermal via array.
  - iii. DBV: There is no exposed pad with the DBV package.
  - (b) i. DRB: The top and bottom copper layers are assumed to have a 20% thermal conductivity of copper representing a 20% copper coverage.
  - ii. DCQ: Each of top and bottom copper layers has a dedicated pattern for 20% copper coverage.
  - iii. DBV: The top and bottom copper layers are assumed to have a 20% thermal conductivity of copper representing a 20% copper coverage.
  - (c) These data were generated with only a single device at the center of a JEDEC high-K (2s2p) board with 3in × 3in copper area. To understand the effects of the copper area on thermal performance, see the [Power Dissipation](#) section of this data sheet.
- (4) The junction-to-ambient thermal resistance under natural convection is obtained in a simulation on a JEDEC-standard, high-K board, as specified in JESD51-7, in an environment described in JESD51-2a.
- (5) The junction-to-case (top) thermal resistance is obtained by simulating a cold plate test on the top of the package. No specific JEDEC-standard test exists, but a close description can be found in the ANSI SEMI standard G30-88.
- (6) The junction-to-board thermal resistance is obtained by simulating in an environment with a ring cold plate fixture to control the PCB temperature, as described in JESD51-8.
- (7) The junction-to-top characterization parameter,  $\psi_{JT}$ , estimates the junction temperature of a device in a real system and is extracted from the simulation data to obtain  $\theta_{JA}$  using a procedure described in JESD51-2a (sections 6 and 7).
- (8) The junction-to-board characterization parameter,  $\psi_{JB}$ , estimates the junction temperature of a device in a real system and is extracted from the simulation data to obtain  $\theta_{JA}$  using a procedure described in JESD51-2a (sections 6 and 7).
- (9) The junction-to-case (bottom) thermal resistance is obtained by simulating a cold plate test on the exposed (power) pad. No specific JEDEC standard test exists, but a close description can be found in the ANSI SEMI standard G30-88.

## 6.5 Electrical Characteristics

Over operating temperature range ( $T_J = -40^\circ\text{C}$  to  $125^\circ\text{C}$ ),  $V_{IN} = V_{OUT(nom)} + 0.5\text{ V}^{(1)}$ ,  $I_{OUT} = 10\text{ mA}$ ,  $V_{EN} = 1.7\text{ V}$ , and  $C_{OUT} = 0.1\text{ }\mu\text{F}$ , unless otherwise noted. Typical values are at  $T_J = 25^\circ\text{C}$ .

PARAMETER		TEST CONDITIONS	MIN	TYP	MAX	UNIT
$V_{IN}$	Input voltage range <sup>(1)(2)</sup>		1.7		5.5	V
$V_{FB}$	Internal reference (TPS73601)	$T_J = 25^\circ\text{C}$	1.198	1.20	1.210	V
$V_{OUT}$	Output voltage range (TPS73601) <sup>(3)</sup>		$V_{FB}$		$5.5 - V_{DO}$	V
	Accuracy <sup>(1)(4)</sup>	Nominal	$T_J = 25^\circ\text{C}$			+0.5
over $V_{IN}$ , $I_{OUT}$ , and T		$V_{OUT} + 0.5\text{ V} \leq V_{IN} \leq 5.5\text{ V}$ ; $10\text{ mA} \leq I_{OUT} \leq 400\text{ mA}$	-1.0%	$\pm 0.5\%$	+1.0%	
$\Delta V_{OUT(\Delta V_{IN})}$	Line regulation <sup>(1)</sup>	$V_{O(nom)} + 0.5\text{ V} \leq V_{IN} \leq 5.5\text{ V}$		0.01		%/V
$\Delta V_{OUT(\Delta I_{OUT})}$	Load regulation	$1\text{ mA} \leq I_{OUT} \leq 400\text{ mA}$		0.002		%mA
		$10\text{ mA} \leq I_{OUT} \leq 400\text{ mA}$		0.0005		
$V_{DO}$	Dropout voltage <sup>(5)</sup> ( $V_{IN} = V_{OUT(nom)} - 0.1\text{ V}$ )	$I_{OUT} = 400\text{ mA}$		75	200	mV
$Z_{O(do)}$	Output impedance in dropout	$1.7\text{ V} \leq V_{IN} \leq V_{OUT} + V_{DO}$		0.25		$\Omega$
$I_{CL}$	Output current limit	$V_{OUT} = 0.9 \times V_{OUT(nom)}$	400	650	800	mA
		$3.6\text{ V} \leq V_{IN} \leq 4.2\text{ V}$ , $0^\circ\text{C} \leq T_J \leq 70^\circ\text{C}$	500		800	
$I_{SC}$	Short-circuit current	$V_{OUT} = 0\text{ V}$		450		mA
$I_{REV}$	Reverse leakage current <sup>(6)</sup> ( $-I_{IN}$ )	$V_{EN} \leq 0.5\text{ V}$ , $0\text{ V} \leq V_{IN} \leq V_{OUT}$		0.1	10	$\mu\text{A}$
$I_{GND}$	GND pin current	$I_{OUT} = 10\text{ mA}$ ( $I_Q$ )		400	550	$\mu\text{A}$
		$I_{OUT} = 400\text{ mA}$		800	1000	
$I_{SHDN}$	Shutdown current ( $I_{GND}$ )	$V_{EN} \leq 0.5\text{ V}$ , $V_{OUT} \leq V_{IN} \leq 5.5$ , $-40^\circ\text{C} \leq T_J \leq 100^\circ\text{C}$		0.02	1	$\mu\text{A}$
$I_{FB}$	FB pin current (TPS73601)			0.1	0.3	$\mu\text{A}$
PSRR	Power-supply rejection ratio (ripple rejection)	$f = 100\text{ Hz}$ , $I_{OUT} = 400\text{ mA}$		58		dB
		$f = 10\text{ kHz}$ , $I_{OUT} = 400\text{ mA}$		37		
$V_n$	Output noise voltage BW = 10Hz – 100KHz	$C_{OUT} = 10\text{ }\mu\text{F}$ , No $C_{NR}$		$27 \times V_{OUT}$		$\mu\text{V}_{RMS}$
		$C_{OUT} = 10\text{ }\mu\text{F}$ , $C_{NR} = 0.01\text{ }\mu\text{F}$		$8.5 \times V_{OUT}$		
$t_{STR}$	Startup time	$V_{OUT} = 3\text{ V}$ , $R_L = 30\text{ }\Omega$ , $C_{OUT} = 1\text{ }\mu\text{F}$ , $C_{NR} = 0.01\text{ }\mu\text{F}$		600		$\mu\text{s}$
$V_{EN(high)}$	EN pin high (enabled)		1.7		$V_{IN}$	V
$V_{EN(low)}$	EN pin low (shutdown)		0		0.5	V
$I_{EN(high)}$	EN pin current (enabled)	$V_{EN} = 5.5\text{ V}$		0.02	0.1	$\mu\text{A}$
$T_{SD}$	Thermal shutdown temperature	Shutdown, temperature increasing		160		$^\circ\text{C}$
		Reset, temperature decreasing		140		
$T_J$	Operating junction temperature		-40		125	$^\circ\text{C}$

(1) Minimum  $V_{IN} = V_{OUT} + V_{DO}$  or 1.7 V, whichever is greater.

(2) For  $V_{OUT(nom)} < 1.6\text{ V}$ , when  $V_{IN} \leq 1.6\text{ V}$ , the output locks to  $V_{IN}$  and may result in a damaging over-voltage level on the output. To avoid this situation, disable the device before powering down the  $V_{IN}$ .

(3) TPS73601 is tested at  $V_{OUT} = 2.5\text{ V}$ .

(4) Tolerance of external resistors not included in this specification.

(5)  $V_{DO}$  is not measured for fixed output versions with  $V_{OUT(nom)} < 1.8\text{ V}$ .

(6) Fixed-voltage versions only; refer to [Application Information](#) section for more information.

### 6.6 Typical Characteristics

For all voltage versions, at  $T_J = 25^\circ\text{C}$ ,  $V_{IN} = V_{OUT(nom)} + 0.5\text{ V}$ ,  $I_{OUT} = 10\text{ mA}$ ,  $V_{EN} = 1.7\text{ V}$ , and  $C_{OUT} = 0.1\text{ }\mu\text{F}$ , unless otherwise noted.

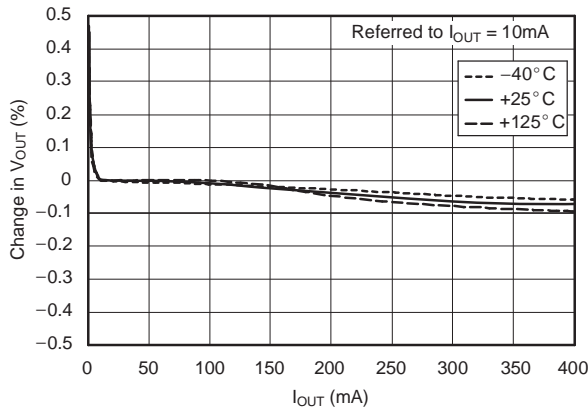

Figure 1. Load Regulation

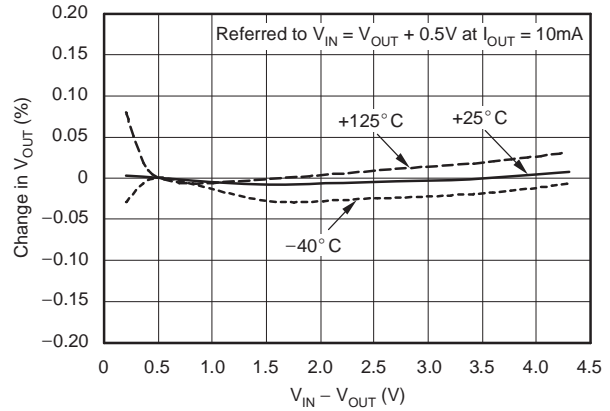

Figure 2. Line Regulation

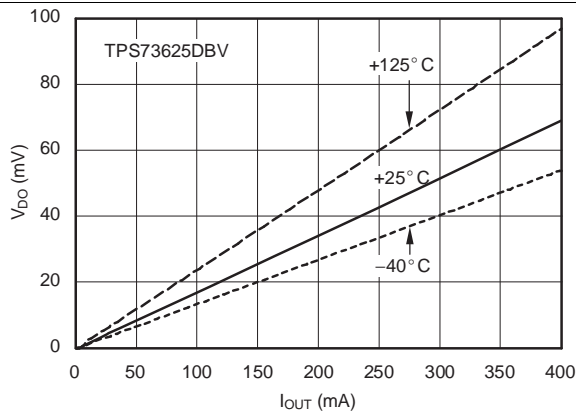

Figure 3. Dropout Voltage vs Output Current

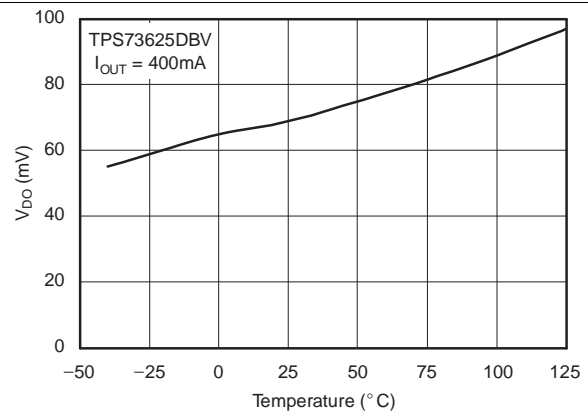

Figure 4. Dropout Voltage vs Temperature

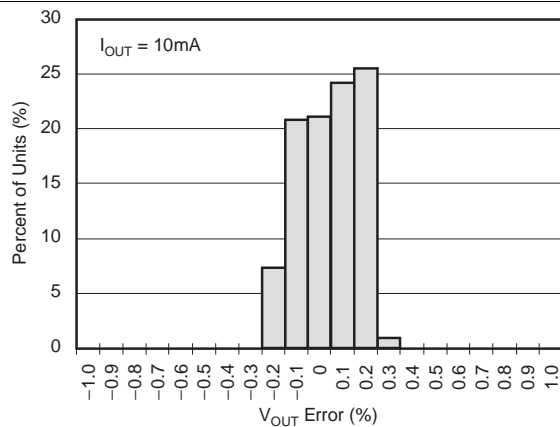

Figure 5. Output Voltage Accuracy Histogram

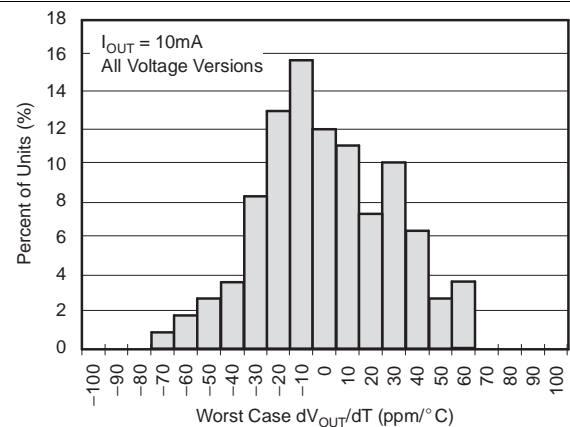

Figure 6. Output Voltage Drift Histogram

Typical Characteristics (continued)

For all voltage versions, at  $T_J = 25^\circ\text{C}$ ,  $V_{IN} = V_{OUT(nom)} + 0.5\text{ V}$ ,  $I_{OUT} = 10\text{ mA}$ ,  $V_{EN} = 1.7\text{ V}$ , and  $C_{OUT} = 0.1\text{ }\mu\text{F}$ , unless otherwise noted.

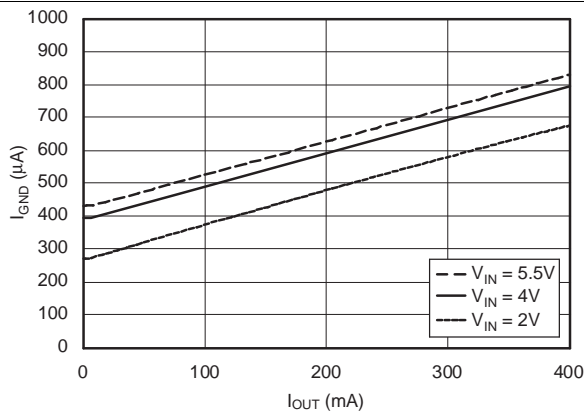

Figure 7. Ground Pin Current vs Output Current

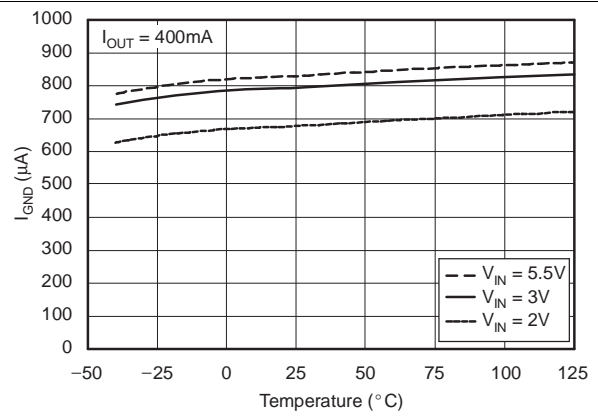

Figure 8. Ground Pin Current vs Temperature

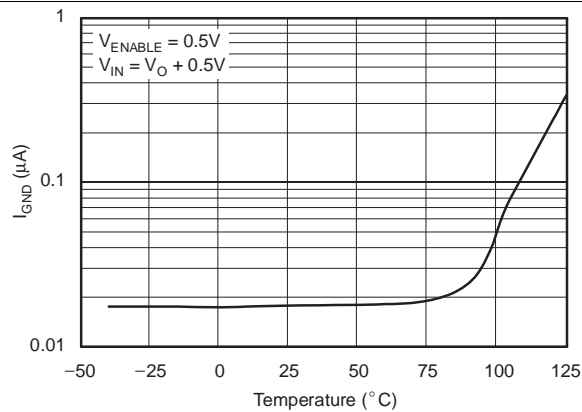

Figure 9. Ground Pin Current In Shutdown vs Temperature

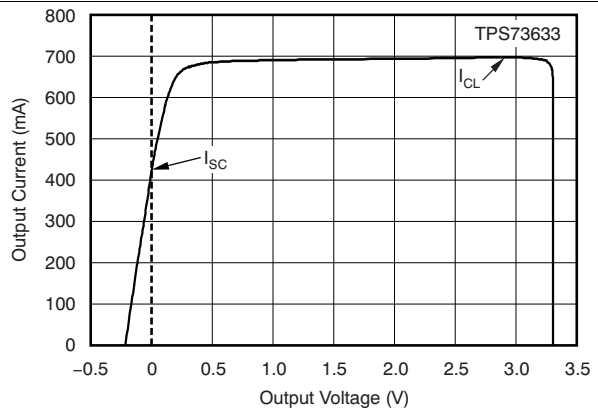

Figure 10. Current Limit vs  $V_{OUT}$ (Foldback)

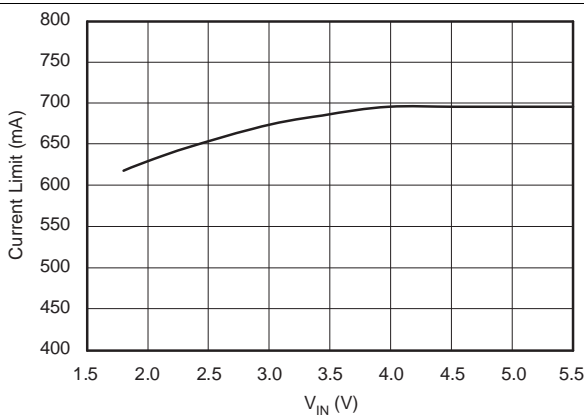

Figure 11. Current Limit vs  $V_{IN}$

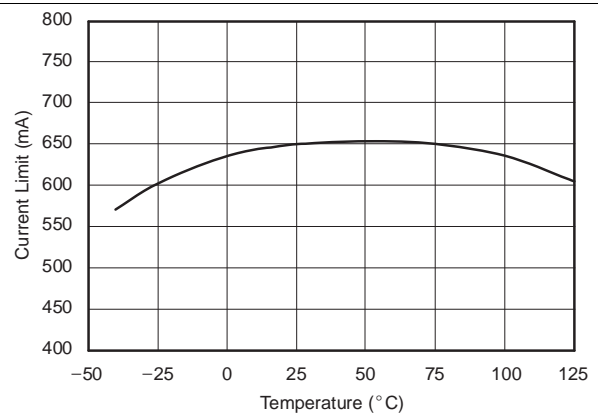

Figure 12. Current Limit vs Temperature



Typical Characteristics (continued)

For all voltage versions, at  $T_J = 25^\circ\text{C}$ ,  $V_{IN} = V_{OUT(nom)} + 0.5\text{ V}$ ,  $I_{OUT} = 10\text{ mA}$ ,  $V_{EN} = 1.7\text{ V}$ , and  $C_{OUT} = 0.1\ \mu\text{F}$ , unless otherwise noted.

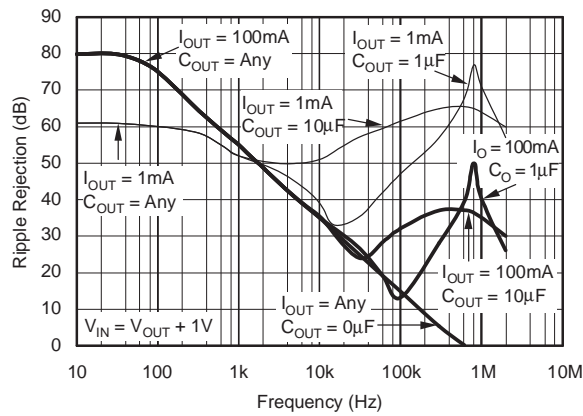

Figure 13. PSRR (Ripple Rejection) vs Frequency

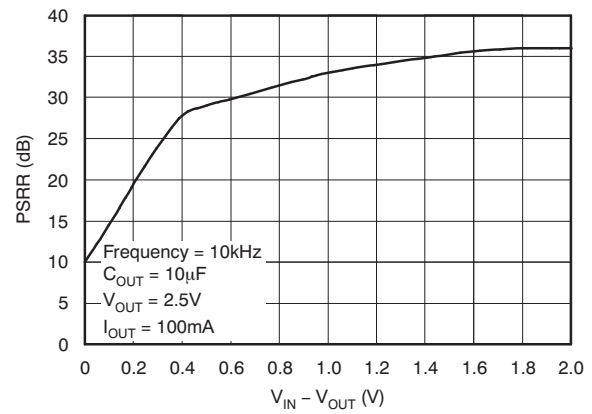

Figure 14. PSRR (Ripple Rejection) vs  $V_{IN} - V_{OUT}$

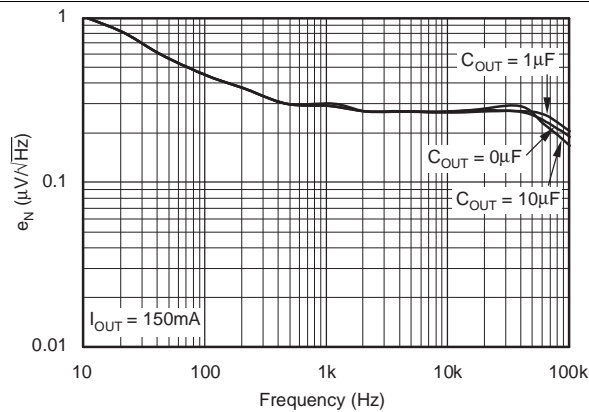

Figure 15. Noise Spectral Density  $c_{NR} = 0\ \mu\text{F}$

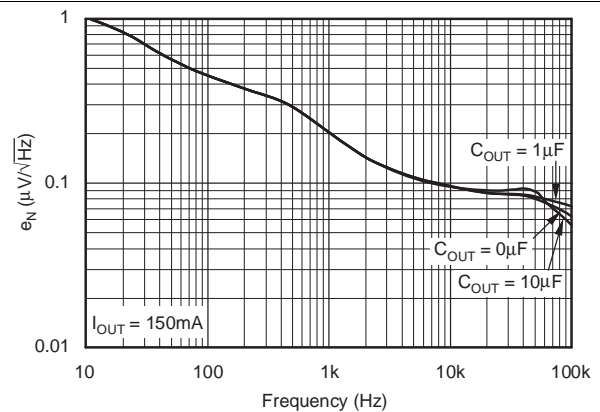

Figure 16. Noise Spectral Density  $c_{NR} = 0.01\ \mu\text{F}$

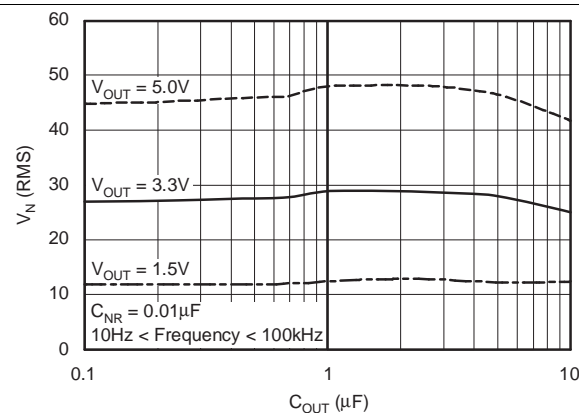

Figure 17. RMS Noise Voltage vs  $C_{OUT}$

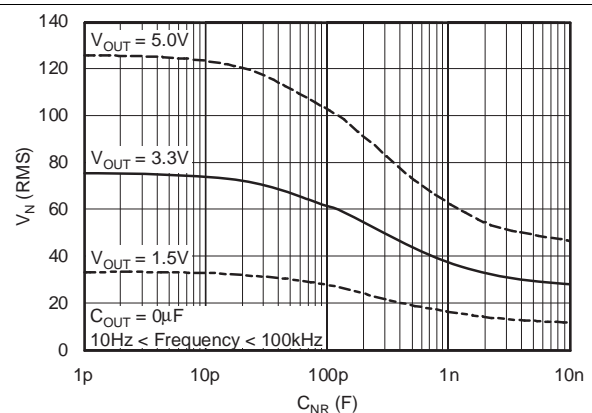

Figure 18. RMS Noise Voltage vs  $C_{NR}$

Typical Characteristics (continued)

For all voltage versions, at  $T_J = 25^\circ\text{C}$ ,  $V_{IN} = V_{OUT(nom)} + 0.5\text{ V}$ ,  $I_{OUT} = 10\text{ mA}$ ,  $V_{EN} = 1.7\text{ V}$ , and  $C_{OUT} = 0.1\text{ }\mu\text{F}$ , unless otherwise noted.

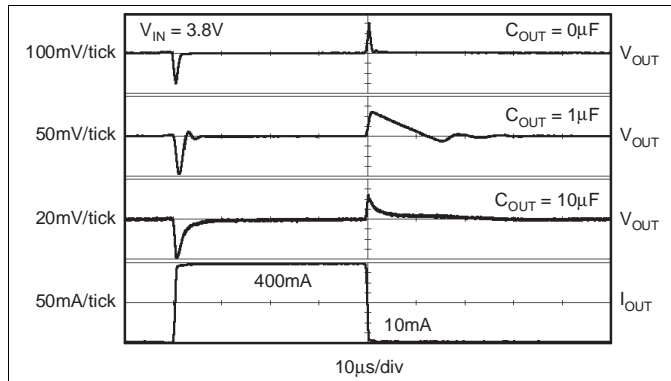

Figure 19. TPS73633 Load Transient Response

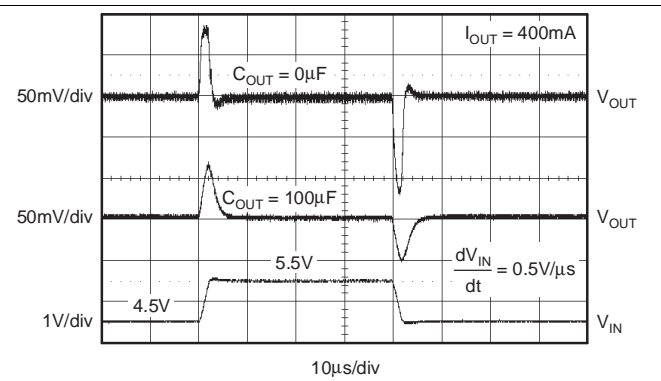

Figure 20. TPS73633 Line Transient Response

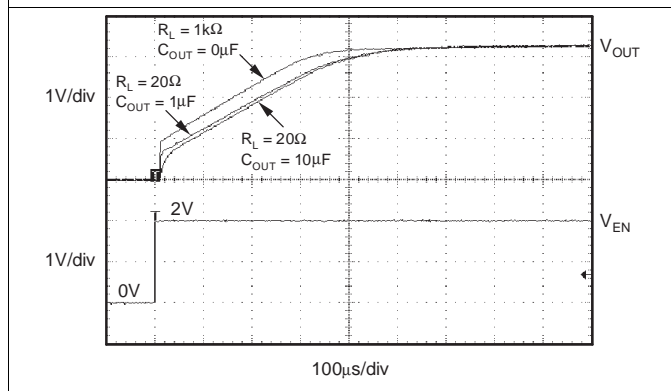

Figure 21. TPS73633 Turn-On Response

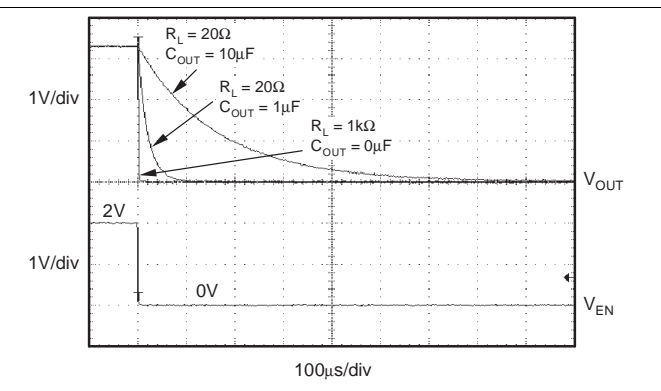

Figure 22. TPS73633 Turn-Off Response

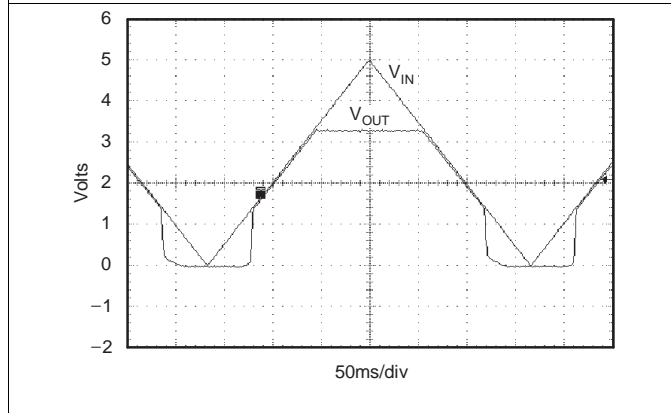

Figure 23. TPS73633 Power Up / Power Down

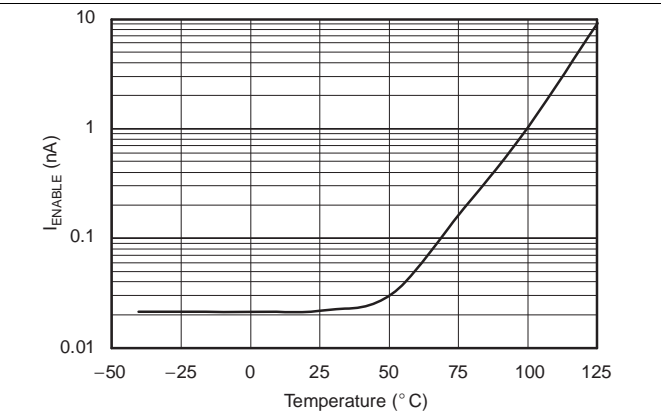

Figure 24.  $I_{ENABLE}$  vs Temperature

Typical Characteristics (continued)

For all voltage versions, at  $T_J = 25^\circ\text{C}$ ,  $V_{IN} = V_{OUT(nom)} + 0.5\text{ V}$ ,  $I_{OUT} = 10\text{ mA}$ ,  $V_{EN} = 1.7\text{ V}$ , and  $C_{OUT} = 0.1\text{ }\mu\text{F}$ , unless otherwise noted.

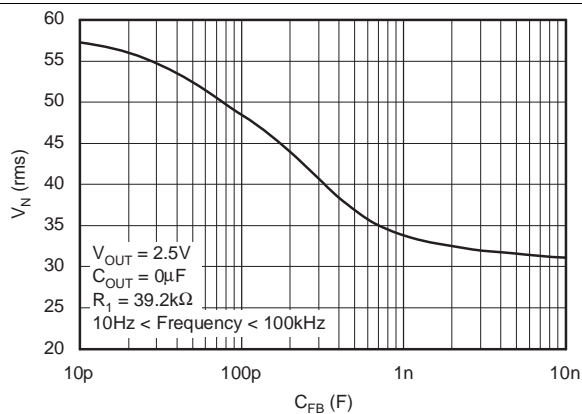

Figure 25. TPS73601 RMS Noise Voltage vs  $C_{FB}$

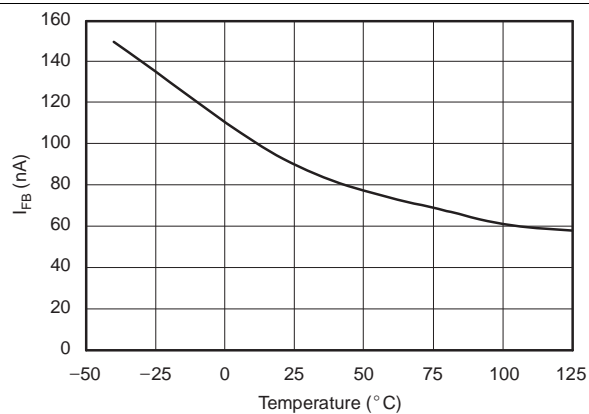

Figure 26. TPS73601  $I_{FB}$  vs Temperature

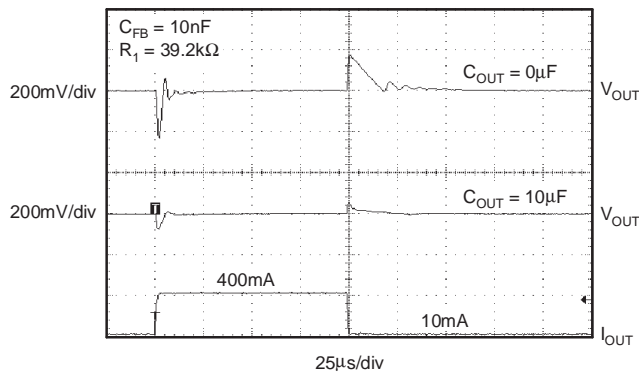

Figure 27. TPS73601 Load Transient, Adjustable Version

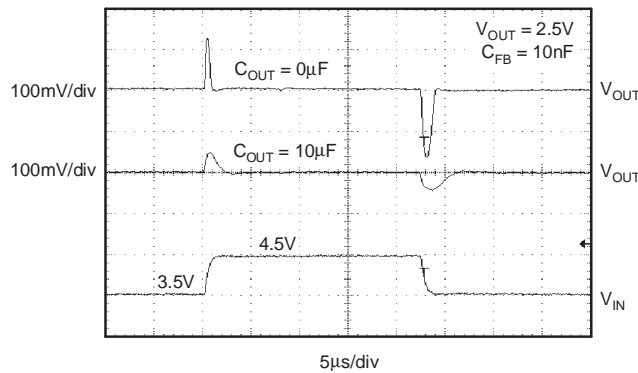

Figure 28. TPS73601 Line Transient, Adjustable Version

## 7 Detailed Description

### 7.1 Overview

The TPS736xx family of low-dropout linear regulators operates down to an input voltage of 1.7 V and supports output voltages down to 1.2 V while sourcing up to 500 mA of load current. This linear regulator utilizes an NMOS pass element with an integrated 4-MHz charge pump to provide a dropout voltage of less than 200 mV at full load current. This unique architecture also permits stable regulation over a wide range of output capacitors. In fact, the TPS736xx family of devices does not require any output capacitor for stability. The increased insensitivity to the output capacitor value and type makes this family of linear regulators an ideal choice when powering a load where the effective capacitance is unknown.

The TPS736xx family of devices also features a noise reduction (NR) pin that allows for additional reduction of the output noise. With a noise reduction capacitor of 0.01  $\mu\text{F}$  connected from the NR pin to GND, the TPS73615 output noise can be as low as 12.75  $\mu\text{V}_{\text{RMS}}$ . The low noise output featured by the TPS736xx family makes it well-suited for powering VCOs or any other noise sensitive load.

### 7.2 Functional Block Diagram

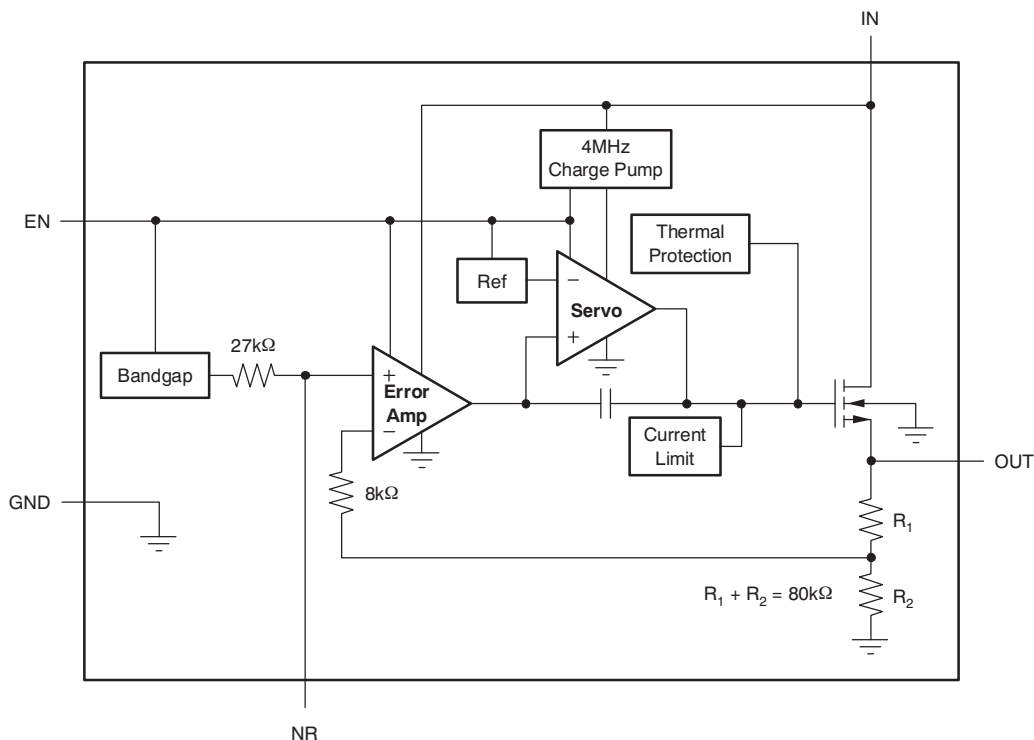

**Figure 29. Fixed-Voltage Version**

Functional Block Diagram (continued)

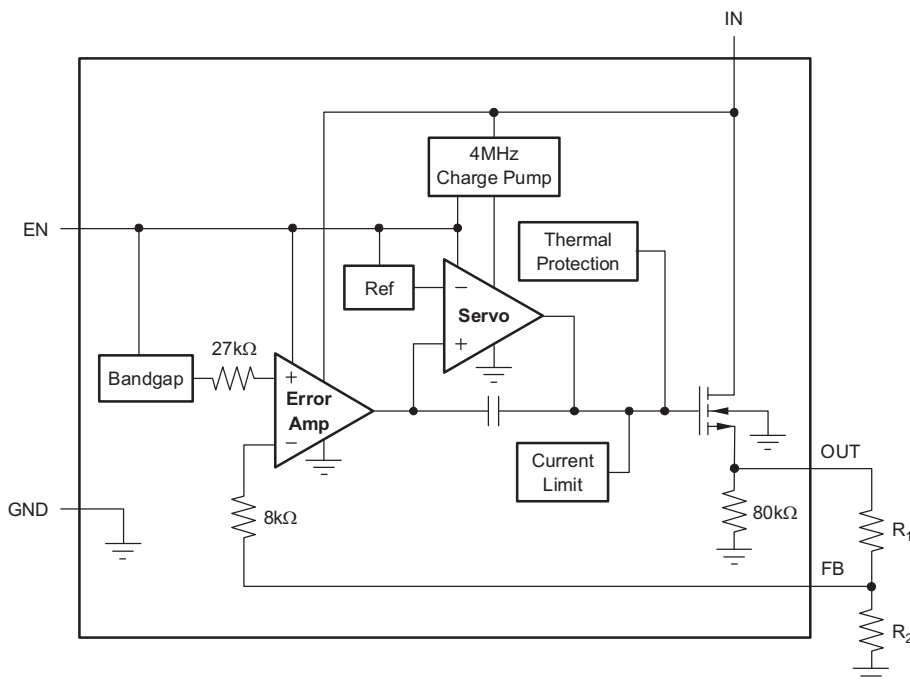

Standard 1% Resistor Values for Common Output Voltages

V <sub>O</sub>	R <sub>1</sub>	R <sub>2</sub>
1.2V	Short	Open
1.5V	23.2kΩ	95.3kΩ
1.8V	28.0kΩ	56.2kΩ
2.5V	39.2kΩ	36.5kΩ
2.8V	44.2kΩ	33.2kΩ
3.0V	46.4kΩ	30.9kΩ
3.3V	52.3kΩ	30.1kΩ

NOTE:  $V_{OUT} = (R_1 + R_2)/R_2 \times 1.204$ ;  
 $R_1 || R_2 \cong 19k\Omega$  for best accuracy.

Figure 30. Adjustable-Voltage Version

7.3 Feature Description

7.3.1 Output Noise

A precision band-gap reference is used to generate the internal reference voltage,  $V_{REF}$ . This reference is the dominant noise source within the TPS736xx and it generates approximately  $32 \mu V_{RMS}$  (10 Hz to 100 kHz) at the reference output (NR). The regulator control loop gains up the reference noise with the same gain as the reference voltage, so that the noise voltage of the regulator is approximately given by:

$$V_N = 32 \mu V_{RMS} \times \frac{(R_1 + R_2)}{R_2} = 32 \mu V_{RMS} \times \frac{V_{OUT}}{V_{REF}} \tag{1}$$

Since the value of  $V_{REF}$  is 1.2 V, this relationship reduces to:

$$V_N(\mu V_{RMS}) = 27 \left( \frac{\mu V_{RMS}}{V} \right) \times V_{OUT}(V) \tag{2}$$

for the case of no  $C_{NR}$ .

An internal 27-kΩ resistor in series with the noise reduction pin (NR) forms a low-pass filter for the voltage reference when an external noise reduction capacitor,  $C_{NR}$ , is connected from NR to ground. For  $C_{NR} = 10$  nF, the total noise in the 10-Hz to 100-kHz bandwidth is reduced by a factor of ~3.2, giving the approximate relationship:

$$V_N(\mu V_{RMS}) = 8.5 \left( \frac{\mu V_{RMS}}{V} \right) \times V_{OUT}(V) \tag{3}$$

for  $C_{NR} = 10$  nF.

This noise reduction effect is shown as *RMS Noise Voltage vs  $C_{NR}$*  in the *Typical Characteristics* section.

## Feature Description (continued)

The TPS73601 adjustable version does not have the NR pin available. However, connecting a feedback capacitor,  $C_{FB}$ , from the output to the feedback pin (FB) reduces output noise and improves load transient performance.

The TPS736xx uses an internal charge pump to develop an internal supply voltage sufficient to drive the gate of the NMOS pass element above  $V_{OUT}$ . The charge pump generates  $\sim 250 \mu V$  of switching noise at  $\sim 4$  MHz; however, charge-pump noise contribution is negligible at the output of the regulator for most values of  $I_{OUT}$  and  $C_{OUT}$ .

### 7.3.2 Internal Current Limit

The TPS736xx internal current limit helps protect the regulator during fault conditions. Foldback current limit helps to protect the regulator from damage during output short-circuit conditions by reducing current limit when  $V_{OUT}$  drops below 0.5 V. See [Figure 10](#) in the *Typical Characteristics* section.

Note from [Figure 10](#) that approximately  $-0.2$  V of  $V_{OUT}$  results in a current limit of 0 mA. Therefore, if OUT is forced below  $-0.2$  V before EN goes high, the device may not start up. In applications that work with both a positive and negative voltage supply, the TPS736xx should be enabled first.

### 7.3.3 Enable Pin and Shutdown

The enable pin (EN) is active high and is compatible with standard TTL-CMOS levels.  $V_{EN}$  below 0.5 V (max) turns the regulator off and drops the GND pin current to approximately 10 nA. When EN is used to shutdown the regulator, all charge is removed from the pass transistor gate, and the output ramps back up to a regulated  $V_{OUT}$  (see [Figure 19](#)).

When shutdown capability is not required, EN can be connected to  $V_{IN}$ . However, the pass gate may not be discharged using this configuration, and the pass transistor may be left on (enhanced) for a significant time after  $V_{IN}$  has been removed. This scenario can result in reverse current flow (if the IN pin is low impedance) and faster ramp times upon power-up. In addition, for  $V_{IN}$  ramp times slower than a few milliseconds, the output may overshoot upon power-up.

Note that current limit foldback can prevent device start-up under some conditions. See the *Internal Current Limit* section for more information.

### 7.3.4 Reverse Current

The NMOS pass element of the TPS736xx provides inherent protection against current flow from the output of the regulator to the input when the gate of the pass device is pulled low. To ensure that all charge is removed from the gate of the pass element, the EN pin must be driven low before the input voltage is removed. If this is not done, the pass element may be left on due to stored charge on the gate.

After the EN pin is driven low, no bias voltage is needed on any pin for reverse current blocking. Note that reverse current is specified as the current flowing out of the IN pin due to voltage applied on the OUT pin. There is additional current flowing into the OUT pin due to the 80-k $\Omega$  internal resistor divider to ground (see [Figure 29](#) and [Figure 30](#)).

For the TPS73601, reverse current may flow when  $V_{FB}$  is more than 1.0 V above  $V_{IN}$ .

## 7.4 Device Functional Modes

### 7.4.1 Normal Operation with $1.7 \text{ V} \leq V_{IN} \leq 5.5 \text{ V}$ and $V_{EN} \geq 1.7 \text{ V}$

The TPS736xx family requires an input voltage of at least 1.7 V to function properly and attempt to maintain regulation. Please note that if the device output voltage is greater than 1.5 V when the input voltage is at 1.7 V, the device is operating in dropout and regulation cannot be maintained. Due to the NMOS architecture used in the TPS736xx devices, the dropout voltage is not a strong function of the input voltage.

When operating the device near 5.5 V, take care to suppress any transient spikes that may exceed the 6.0-V absolute maximum voltage rating. The device should never operate at a dc voltage greater than 5.5 V.

## 8 Application and Implementation

### NOTE

Information in the following applications sections is not part of the TI component specification, and TI does not warrant its accuracy or completeness. TI's customers are responsible for determining suitability of components for their purposes. Customers should validate and test their design implementation to confirm system functionality.

### 8.1 Application Information

The TPS736xx belongs to a family of new generation LDO regulators that use an NMOS pass transistor to achieve ultra-low-dropout performance, reverse current blockage, and freedom from output capacitor constraints. These features, combined with low noise and an enable input, make the TPS736xx ideal for portable applications. This regulator family offers a wide selection of fixed output voltage versions and an adjustable output version. All versions have thermal and over-current protection, including foldback current limit.

### 8.2 Typical Applications

Figure 31 shows the basic circuit connections for the fixed voltage models. Figure 32 gives the connections for the adjustable output version (TPS73601).

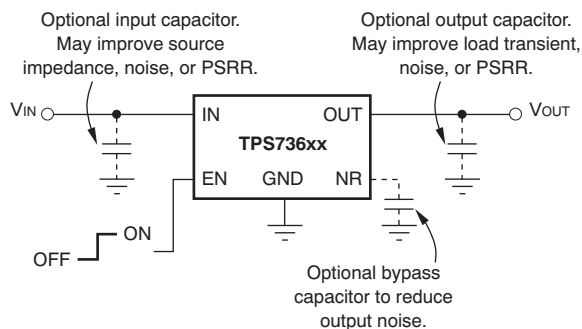

Figure 31. Typical Application Circuit for Fixed-Voltage Versions

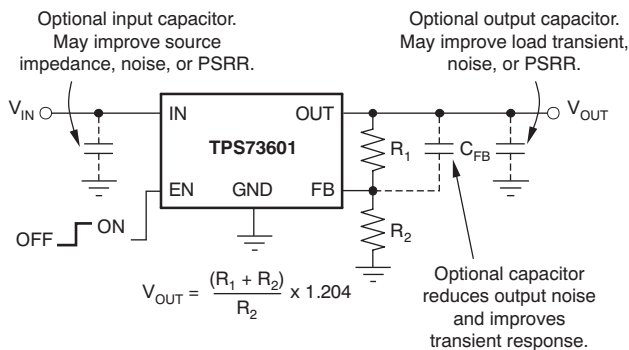

Figure 32. Typical Application Circuit for Adjustable-Voltage Version

## Typical Applications (continued)

### 8.2.1 Design Requirements

For this design example, use the parameters listed in [Table 1](#) below as the input parameters.

**Table 1. Design Parameters (Fixed-Voltage Version)**

PARAMETER	DESIGN REQUIREMENT
Input voltage	5 V, $\pm 3\%$
Output voltage	3.3 V, $\pm 1\%$
Output current	500 mA (maximum), 20 mA (minimum)
RMS noise, 10 Hz to 100 kHz	$< 30 \mu\text{V}_{\text{RMS}}$
Ambient temperature	55°C (Maximum)

**Table 2. Design Parameters (Adjustable-Voltage Version)**

PARAMETER	DESIGN REQUIREMENT
Input voltage	5 V, $\pm 3\%$ , provided by the dc/dc converter switching at 1 MHz
Output voltage	2.5 V, $\pm 1\%$
Output current	0.4 A (maximum), 10 mA (minimum)
RMS noise, 10 Hz to 100 kHz	$< 35 \mu\text{V}_{\text{RMS}}$
Ambient temperature	55°C (Maximum)

### 8.2.2 Detailed Design Procedure

The first step when designing with a linear regulator is to examine the maximum load current along with the input and output voltage requirements to determine if the device thermal and dropout voltage requirements can be met. At 0.5 A, the dropout voltage of the TPS73633 is a maximum of 200 mV over temperature; thus, the dropout headroom is sufficient for operation over both input and output voltage accuracy.

The maximum power dissipated in the linear regulator is the maximum voltage dropped across the pass element from the input to the output times the maximum load current. In this example, the maximum voltage drop across in the pass element is 5 V + 3% (5.15 V) minus 3.3 V – 1% (3.267 V) or 1.883 V. The power dissipated in the pass element is calculated by taking this voltage drop multiplied by the maximum load current. For this example, the maximum power dissipated in the linear regulator is 942 mW. Once the power dissipated in the linear regulator is known, the corresponding junction temperature rise can be calculated. To calculate the junction temperature rise above ambient, the power dissipated must be multiplied by the junction-to-ambient thermal resistance. For thermal resistance information please refer to [Thermal Protection](#). For this example, using the DRB package, the maximum junction temperature rise is calculated to be 45°C. The maximum junction temperature rise is calculated by adding junction temperature rise to the maximum ambient temperature. In this example, the maximum junction temperature is 100°C. Keep in mind the maximum junction temperature must be below 125°C for reliable operation. Addition ground planes, added thermal vias, and air flow all help to lower the maximum junction temperature. Using the DCQ or DBV packages are not recommended for this application due to the excessive junction temperature rise that would be incurred.

To get the noise level below  $30 \mu\text{V}_{\text{RMS}}$ , a noise reduction capacitance ( $C_{\text{NR}}$ ) of 10 nF is selected along with an output capacitance of 10  $\mu\text{F}$ . Referencing the [Output Noise](#) section, the RMS noise can be calculated to be  $28 \mu\text{V}_{\text{RMS}}$ .

Use of an input capacitor is optional. However, in systems where the input supply is located several inches away from the LDO, a small 0.1- $\mu\text{F}$  input capacitor is recommended to negate the adverse effects that input supply inductance has on stability and ac performance.

In the same way as with designing with a fixed output voltage, the first step is to examine the maximum load current along with the input and output voltage requirements to determine if the device thermal and dropout voltage requirements are met. At 0.4 A, the maximum dropout voltage can be approximated by assuming a linear characteristic of the dropout voltage with load current. The maximum dropout voltage can be estimated to be 200 mV times the ratio of the load current to specified dropout voltage load current. For this example, the dropout can be estimated to be  $200 \text{ mV} \times 400 \text{ mA}/500 \text{ mA}$  or 160 mV. Since the input voltage is 5 V and the output voltage is 2.5 V, there is more than sufficient voltage headroom to avoid dropout and maintain good PSRR.



The maximum power dissipated in the linear regulator is the maximum voltage dropped across the pass element from the input to the output times the maximum load current. In this example, the maximum voltage drop across the pass element is  $5\text{ V} + 3\%$  (5.15 V) minus  $2.5\text{ V} - 1\%$  (2.475 V) or 2.675 V. The power dissipated in the pass element is calculated by taking this voltage drop multiplied by the maximum load current. For this example, the maximum power dissipated in the linear regulator is 1.07 W. Once the power dissipated in the linear regulator is known, the corresponding junction temperature rise can be calculated. To calculate the junction temperature rise above ambient, the power dissipated must be multiplied by the junction-to-ambient thermal resistance. For thermal resistance information, refer to [Thermal Information](#). For this example, using the DRB package, the maximum junction temperature rise is calculated to be 51°C. The maximum junction temperature rise is calculated by adding junction temperature rise to the maximum ambient temperature. In this example, the maximum junction temperature is 106°C. Keep in mind the maximum junction temperature must be below 125°C for reliable operation. Addition ground planes, added thermal vias, and air flow all help to lower the maximum junction temperature. Using the DCQ or DBV packages are not recommended for this application due to the excessive junction temperature rise that would be incurred.

$R_1$  and  $R_2$  can be calculated for any output voltage using the formula shown in [Figure 32](#). Sample resistor values for common output voltages are shown in [Figure 30](#).

For best accuracy, make the parallel combination of  $R_1$  and  $R_2$  approximately equal to 19 k $\Omega$ . This 19 k $\Omega$ , in addition to the internal 8-k $\Omega$  resistor, presents the same impedance to the error amp as the 27-k $\Omega$  bandgap reference output. This impedance helps compensate for leakages into the error amp terminals.

Using the values shown in [Figure 40xx](#) for a 2.5-V output results in a values of 39.2 k $\Omega$  for  $R_1$  and 36.5 k $\Omega$  for  $R_2$ .

To get the noise level below 35  $\mu\text{V}_{\text{RMS}}$ , a noise reduction capacitance ( $C_{\text{FF}}$ ) of 10 nF is selected. [Figure 25](#) should be used as a reference when selecting optimal value for  $C_{\text{FF}}$ .

A 10- $\mu\text{F}$ , low equivalent series resistance (ESR) ceramic X5R capacitor was used on the output of this design to minimize the output voltage droop during a low transient. Use of an input capacitor is optional. However, in systems where the input supply is located several inches away from the LDO, a small 0.1- $\mu\text{F}$  input capacitor is recommended to negate the adverse effects that input supply inductance has on stability and ac performance. Refer to [Input and Output Capacitor Requirements](#) for additional information about input and output capacitor selection.

### 8.2.2.1 Input and Output Capacitor Requirements

Although an input capacitor is not required for stability, it is good analog design practice to connect a 0.1- $\mu\text{F}$  to 1- $\mu\text{F}$ , low ESR capacitor across the input supply near the regulator. This capacitor counteracts reactive input sources and improves transient response, noise rejection, and ripple rejection. A higher-value capacitor may be necessary if large, fast rise-time load transients are anticipated or the device is located several inches from the power source.

The TPS736xx does not require an output capacitor for stability and has maximum phase margin with no capacitor. It is designed to be stable for all available types and values of capacitors. In applications where multiple low ESR capacitors are in parallel, ringing may occur when the product of  $C_{\text{OUT}}$  and total ESR drops below 50 n $\Omega$ F. Total ESR includes all parasitic resistances, including capacitor ESR and board, socket, and solder joint resistance. In most applications, the sum of capacitor ESR and trace resistance meets this requirement.

### 8.2.2.2 Dropout Voltage

The TPS736xx uses an NMOS pass transistor to achieve extremely low dropout. When  $(V_{IN} - V_{OUT})$  is less than the dropout voltage ( $V_{DO}$ ), the NMOS pass device is in its linear region of operation and the input-to-output resistance is the  $R_{DS(on)}$  of the NMOS pass element.

For large step changes in load current, the TPS736xx requires a larger voltage drop from  $V_{IN}$  to  $V_{OUT}$  to avoid degraded transient response. The boundary of this transient dropout region is approximately twice the dc dropout. Values of  $V_{IN} - V_{OUT}$  above this line ensure normal transient response.

Operating in the transient dropout region can cause an increase in recovery time. The time required to recover from a load transient is a function of the magnitude of the change in load current rate, the rate of change in load current, and the available headroom ( $V_{IN}$  to  $V_{OUT}$  voltage drop). Under worst-case conditions [full-scale instantaneous load change with  $(V_{IN} - V_{OUT})$  close to dc dropout levels], the TPS736xx can take a couple of hundred microseconds to return to the specified regulation accuracy.

### 8.2.2.3 Transient Response

The low open-loop output impedance provided by the NMOS pass element in a voltage follower configuration allows operation without an output capacitor for many applications. As with any regulator, the addition of a capacitor (nominal value 1  $\mu$ F) from the OUT pin to ground reduces undershoot magnitude but increase its duration. In the adjustable version, the addition of a capacitor,  $C_{FB}$ , from the OUT pin to the FB pin also improves the transient response.

The TPS736xx does not have active pull-down when the output is over-voltage. This feature allows applications that connect higher voltage sources, such as alternate power supplies, to the output. This feature also results in an output overshoot of several percent if load current quickly drops to zero when a capacitor is connected to the output. The duration of overshoot can be reduced by adding a load resistor. The overshoot decays at a rate determined by output capacitor  $C_{OUT}$  and the internal/external load resistance. The rate of decay is given by:

(Fixed Voltage Version)

$$dV/dt = \frac{V_{OUT}}{C_{OUT} \times 80k\Omega \parallel R_{LOAD}} \quad (4)$$

(Adjustable Voltage Version)

$$dV/dt = \frac{V_{OUT}}{C_{OUT} \times 80k\Omega \parallel (R_1 + R_2) \parallel R_{LOAD}} \quad (5)$$

8.2.3 Application Curves

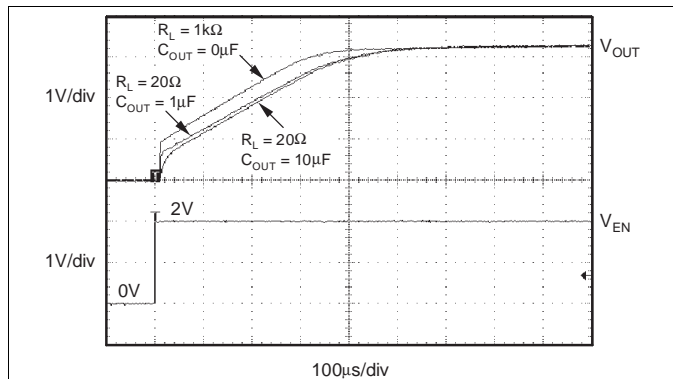

Figure 33. TPS73633 Turn-On Response

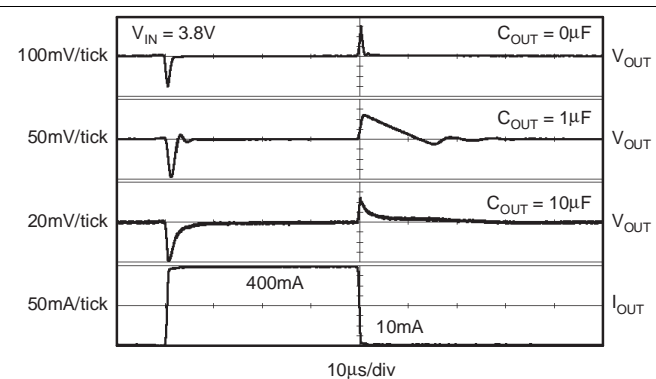

Figure 34. TPS73633 Load Transient Response

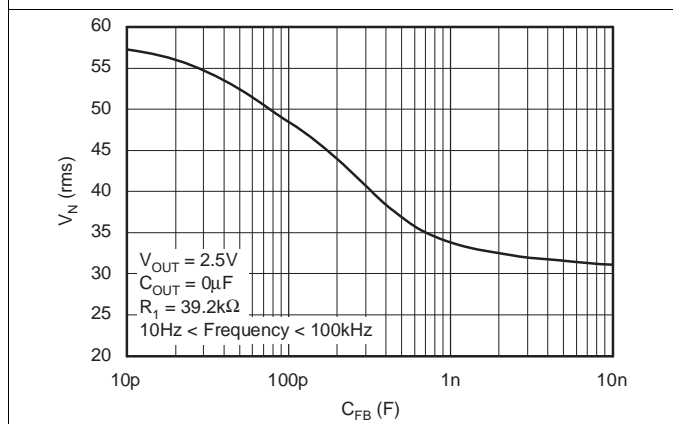

Figure 35. TPS73601 RMS Noise Voltage vs C<sub>FB</sub>

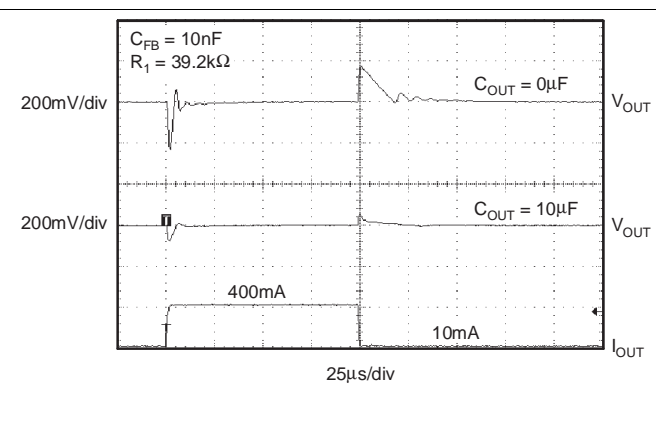

Figure 36. TPS73601 Load Transient, Adjustable Version

## 9 Power Supply Recommendations

This device is designed to operate with an input supply range of 1.7 V to 5.5 V. If the input supply is noisy, additional input capacitors with low ESR can help improve output noise performance.

## 10 Layout

### 10.1 Layout Guidelines

To improve ac performance such as PSRR, output noise, and transient response, it is recommended that the board be designed with separate ground planes for  $V_{IN}$  and  $V_{OUT}$ , with each ground plane connected only at the GND pin of the device. In addition, the ground connection for the bypass capacitor should connect directly to the GND pin of the device.

### 10.2 Layout Examples

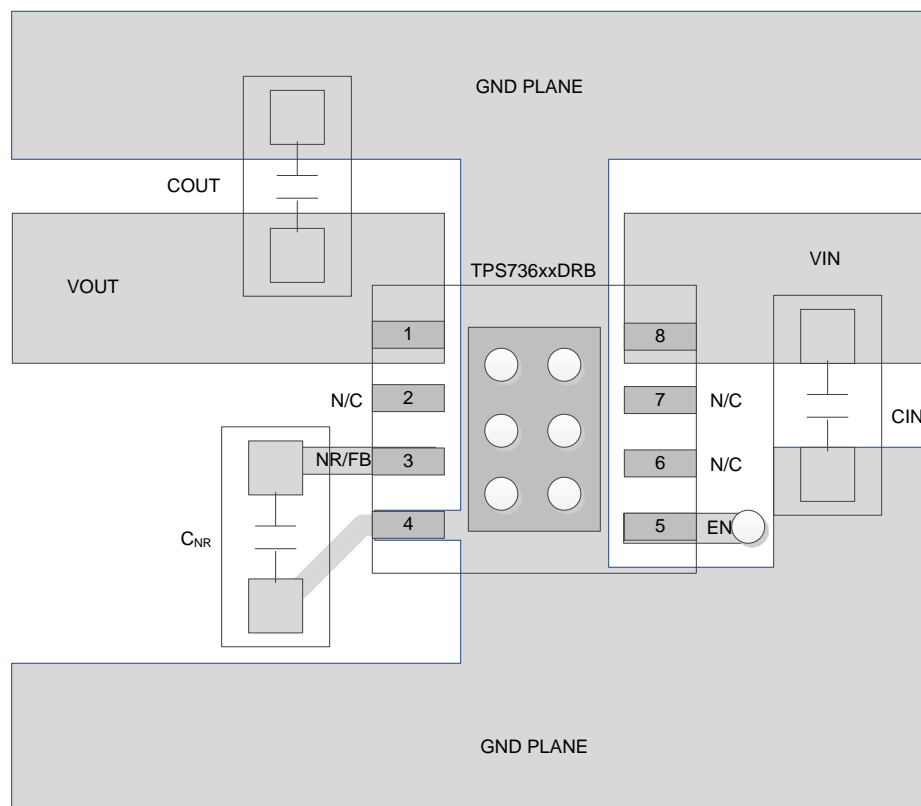

**Figure 37. Fixed Output Voltage Option Layout (DRB Package)**

Layout Examples (continued)

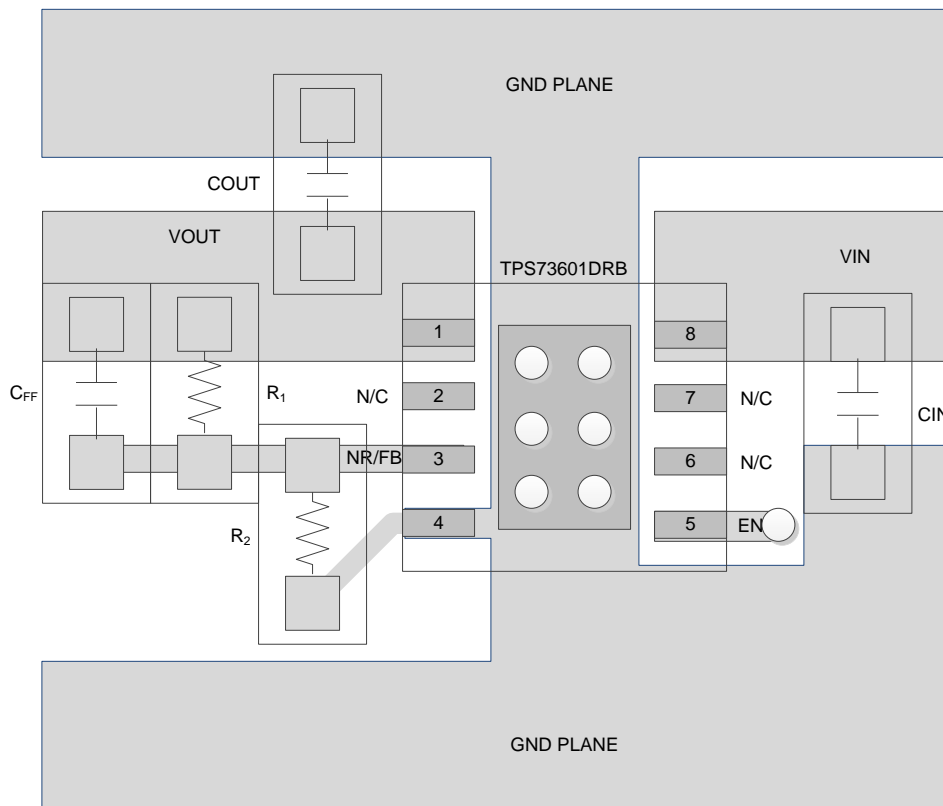

Figure 38. Adjustable Output Voltage Option Layout (DRB Package)

10.3 Power Dissipation

The ability to remove heat from the die is different for each package type, presenting different considerations in the PCB layout. The PCB area around the device that is free of other components moves the heat from the device to the ambient air. Performance data for JEDEC low- and high-K boards are shown in the [Thermal Information](#) table. Using heavier copper increases the effectiveness in removing heat from the device. The addition of plated through-holes to heat-dissipating layers also improves the heat-sink effectiveness.

Power dissipation depends on input voltage and load conditions. Power dissipation ( $P_D$ ) is equal to the product of the output current times the voltage drop across the output pass element ( $V_{IN}$  to  $V_{OUT}$ ):

$$P_D = (V_{IN} - V_{OUT}) \times I_{OUT} \tag{6}$$

Power dissipation can be minimized by using the lowest possible input voltage necessary to assure the required output voltage.

## 10.4 Thermal Protection

Thermal protection disables the output when the junction temperature rises to approximately 160°C, allowing the device to cool. When the junction temperature cools to approximately 140°C, the output circuitry is again enabled. Depending on power dissipation, thermal resistance, and ambient temperature, the thermal protection circuit may cycle on and off. This limits the dissipation of the regulator, protecting it from damage due to overheating.

Any tendency to activate the thermal protection circuit indicates excessive power dissipation or an inadequate heat sink. For reliable operation, junction temperature should be limited to 125°C maximum. To estimate the margin of safety in a complete design (including heat sink), increase the ambient temperature until the thermal protection is triggered; use worst-case loads and signal conditions. For good reliability, thermal protection should trigger at least 35°C above the maximum expected ambient condition of your application. This produces a worst-case junction temperature of 125°C at the highest expected ambient temperature and worst-case load.

The internal protection circuitry of the TPS736xx has been designed to protect against overload conditions. It was not intended to replace proper heat sinking. Continuously running the TPS736xx into thermal shutdown degrades device reliability.

## 10.5 Package Mounting

Solder pad footprint recommendations for the TPS736xx are presented in Application Note *Solder Pad Recommendations for Surface-Mount Devices (SBFA015)*, available from the Texas Instruments web site at [www.ti.com](http://www.ti.com).

## 11 Device and Documentation Support

### 11.1 Device Support

#### 11.1.1 Development Support

##### 11.1.1.1 Evaluation Modules

An evaluation module (EVM) is available to assist in the initial circuit performance evaluation using the TPS736xx. The [TPS73601DRBEVM-518 evaluation module](#) (and [related user guide](#)) can be requested at the Texas Instruments website through the product folders or purchased directly from the [TI eStore](#).

##### 11.1.1.2 Spice Models

Computer simulation of circuit performance using SPICE is often useful when analyzing the performance of analog circuits and systems. A SPICE model for the TPS736 is available through the product folders under *Simulation Models*.

#### 11.1.2 Device Nomenclature

**Table 3. Device Nomenclature<sup>(1)</sup>**

PRODUCT	V <sub>OUT</sub>
TPS736xx yyy z	XX is the nominal output voltage (for example, 25 = 2.5 V; 01 = Adjustable). YYY is the package designator. Z is the tape and reel quantity (R = 3000, T = 250).

(1) For the most current package and ordering information see the Package Option Addendum at the end of this document, or see the TI web site at [www.ti.com](http://www.ti.com).

### 11.2 Documentation Support

#### 11.2.1 Related Documentation

- Application note. *Regulating V<sub>OUT</sub> Below 1.2 V Using an External Reference*. Literature number [SLVA216](#).
- TPS73x01DRBEVM-518 User's Guide. Literature number [SBVU014](#).

### 11.3 Trademarks

All trademarks are the property of their respective owners.

### 11.4 Electrostatic Discharge Caution



These devices have limited built-in ESD protection. The leads should be shorted together or the device placed in conductive foam during storage or handling to prevent electrostatic damage to the MOS gates.

### 11.5 Glossary

[SLYZ022](#) — *TI Glossary*.

This glossary lists and explains terms, acronyms, and definitions.

## 12 Mechanical, Packaging, and Orderable Information

The following pages include mechanical, packaging, and orderable information. This information is the most current data available for the designated devices. This data is subject to change without notice and revision of this document. For browser-based versions of this data sheet, refer to the left-hand navigation.

**PACKAGING INFORMATION**

Orderable Device	Status (1)	Package Type	Package Drawing	Pins	Package Qty	Eco Plan (2)	Lead/Ball Finish (6)	MSL Peak Temp (3)	Op Temp (°C)	Device Marking (4/5)	Samples
TPS73601DBVR	ACTIVE	SOT-23	DBV	5	3000	Green (RoHS & no Sb/Br)	NIPDAU	Level-1-260C-UNLIM	-40 to 125	PJFQ	<a href="#">Samples</a>
TPS73601DBVRG4	ACTIVE	SOT-23	DBV	5	3000	Green (RoHS & no Sb/Br)	NIPDAU	Level-1-260C-UNLIM	-40 to 125	PJFQ	<a href="#">Samples</a>
TPS73601DBVT	ACTIVE	SOT-23	DBV	5	250	Green (RoHS & no Sb/Br)	NIPDAU	Level-1-260C-UNLIM	-40 to 125	PJFQ	<a href="#">Samples</a>
TPS73601DBVTG4	ACTIVE	SOT-23	DBV	5	250	Green (RoHS & no Sb/Br)	NIPDAU	Level-1-260C-UNLIM	-40 to 125	PJFQ	<a href="#">Samples</a>
TPS73601DCQ	ACTIVE	SOT-223	DCQ	6	78	Green (RoHS & no Sb/Br)	SN	Level-2-260C-1 YEAR	-40 to 125	PS73601	<a href="#">Samples</a>
TPS73601DCQG4	ACTIVE	SOT-223	DCQ	6	78	Green (RoHS & no Sb/Br)	NIPDAU	Level-2-260C-1 YEAR	-40 to 125	PS73601	<a href="#">Samples</a>
TPS73601DCQR	ACTIVE	SOT-223	DCQ	6	2500	Green (RoHS & no Sb/Br)	SN	Level-2-260C-1 YEAR	-40 to 125	PS73601	<a href="#">Samples</a>
TPS73601DCQRG4	ACTIVE	SOT-223	DCQ	6	2500	Green (RoHS & no Sb/Br)	NIPDAU	Level-2-260C-1 YEAR	-40 to 125	PS73601	<a href="#">Samples</a>
TPS73601DRBR	ACTIVE	SON	DRB	8	3000	Green (RoHS & no Sb/Br)	NIPDAU	Level-2-260C-1 YEAR	-40 to 125	PJFQ	<a href="#">Samples</a>
TPS73601DRBRG4	ACTIVE	SON	DRB	8	3000	Green (RoHS & no Sb/Br)	NIPDAU	Level-2-260C-1 YEAR	-40 to 125	PJFQ	<a href="#">Samples</a>
TPS73601DRBT	ACTIVE	SON	DRB	8	250	Green (RoHS & no Sb/Br)	NIPDAU	Level-2-260C-1 YEAR	-40 to 125	PJFQ	<a href="#">Samples</a>
TPS73601DRBTG4	ACTIVE	SON	DRB	8	250	Green (RoHS & no Sb/Br)	NIPDAU	Level-2-260C-1 YEAR	-40 to 125	PJFQ	<a href="#">Samples</a>
TPS736125DRBR	ACTIVE	SON	DRB	8	3000	Green (RoHS & no Sb/Br)	NIPDAU	Level-2-260C-1 YEAR	-40 to 125	T49	<a href="#">Samples</a>
TPS736125DRBT	ACTIVE	SON	DRB	8	250	Green (RoHS & no Sb/Br)	NIPDAU	Level-2-260C-1 YEAR	-40 to 125	T49	<a href="#">Samples</a>
TPS73615DBVR	ACTIVE	SOT-23	DBV	5	3000	Green (RoHS & no Sb/Br)	NIPDAU	Level-1-260C-UNLIM	-40 to 125	T44	<a href="#">Samples</a>
TPS73615DBVT	ACTIVE	SOT-23	DBV	5	250	Green (RoHS & no Sb/Br)	NIPDAU	Level-1-260C-UNLIM	-40 to 125	T44	<a href="#">Samples</a>
TPS73615DCQ	ACTIVE	SOT-223	DCQ	6	78	Green (RoHS & no Sb/Br)	NIPDAU	Level-2-260C-1 YEAR	-40 to 125	PS73615	<a href="#">Samples</a>



Orderable Device	Status (1)	Package Type	Package Drawing	Pins	Package Qty	Eco Plan (2)	Lead/Ball Finish (6)	MSL Peak Temp (3)	Op Temp (°C)	Device Marking (4/5)	Samples
TPS73615DCQR	ACTIVE	SOT-223	DCQ	6	2500	Green (RoHS & no Sb/Br)	SN	Level-2-260C-1 YEAR	-40 to 125	PS73615	<a href="#">Samples</a>
TPS73615DCQRG4	ACTIVE	SOT-223	DCQ	6	2500	Green (RoHS & no Sb/Br)	NIPDAU	Level-2-260C-1 YEAR	-40 to 125	PS73615	<a href="#">Samples</a>
TPS73615DRBR	ACTIVE	SON	DRB	8	3000	Green (RoHS & no Sb/Br)	NIPDAU	Level-2-260C-1 YEAR	-40 to 125	T44	<a href="#">Samples</a>
TPS73615DRBT	ACTIVE	SON	DRB	8	250	Green (RoHS & no Sb/Br)	NIPDAU	Level-2-260C-1 YEAR	-40 to 125	T44	<a href="#">Samples</a>
TPS73615DRBTG4	ACTIVE	SON	DRB	8	250	Green (RoHS & no Sb/Br)	NIPDAU	Level-2-260C-1 YEAR	-40 to 125	T44	<a href="#">Samples</a>
TPS73616DBVR	ACTIVE	SOT-23	DBV	5	3000	Green (RoHS & no Sb/Br)	NIPDAU	Level-1-260C-UNLIM	-40 to 125	OCQ	<a href="#">Samples</a>
TPS73616DBVT	ACTIVE	SOT-23	DBV	5	250	Green (RoHS & no Sb/Br)	NIPDAU	Level-1-260C-UNLIM	-40 to 125	OCQ	<a href="#">Samples</a>
TPS73618DBVR	ACTIVE	SOT-23	DBV	5	3000	Green (RoHS & no Sb/Br)	NIPDAU	Level-1-260C-UNLIM	-40 to 125	T43	<a href="#">Samples</a>
TPS73618DBVRG4	ACTIVE	SOT-23	DBV	5	3000	Green (RoHS & no Sb/Br)	NIPDAU	Level-1-260C-UNLIM	-40 to 125	T43	<a href="#">Samples</a>
TPS73618DBVT	ACTIVE	SOT-23	DBV	5	250	Green (RoHS & no Sb/Br)	NIPDAU	Level-1-260C-UNLIM	-40 to 125	T43	<a href="#">Samples</a>
TPS73618DBVTG4	ACTIVE	SOT-23	DBV	5	250	Green (RoHS & no Sb/Br)	NIPDAU	Level-1-260C-UNLIM	-40 to 125	T43	<a href="#">Samples</a>
TPS73618DCQ	ACTIVE	SOT-223	DCQ	6	78	Green (RoHS & no Sb/Br)	NIPDAU	Level-2-260C-1 YEAR	-40 to 125	PS73618	<a href="#">Samples</a>
TPS73618DCQR	ACTIVE	SOT-223	DCQ	6	2500	Green (RoHS & no Sb/Br)	SN	Level-2-260C-1 YEAR	-40 to 125	PS73618	<a href="#">Samples</a>
TPS73618DCQRG4	ACTIVE	SOT-223	DCQ	6	2500	Green (RoHS & no Sb/Br)	NIPDAU	Level-2-260C-1 YEAR	-40 to 125	PS73618	<a href="#">Samples</a>
TPS73619DRBR	ACTIVE	SON	DRB	8	3000	Green (RoHS & no Sb/Br)	NIPDAU	Level-2-260C-1 YEAR	-40 to 125	BYY	<a href="#">Samples</a>
TPS73619DRBT	ACTIVE	SON	DRB	8	250	Green (RoHS & no Sb/Br)	NIPDAU	Level-2-260C-1 YEAR	-40 to 125	BYY	<a href="#">Samples</a>
TPS73625DBVR	ACTIVE	SOT-23	DBV	5	3000	Green (RoHS & no Sb/Br)	NIPDAU	Level-1-260C-UNLIM	-40 to 125	T42	<a href="#">Samples</a>
TPS73625DBVRG4	ACTIVE	SOT-23	DBV	5	3000	Green (RoHS & no Sb/Br)	NIPDAU	Level-1-260C-UNLIM	-40 to 125	T42	<a href="#">Samples</a>

Orderable Device	Status (1)	Package Type	Package Drawing	Pins	Package Qty	Eco Plan (2)	Lead/Ball Finish (6)	MSL Peak Temp (3)	Op Temp (°C)	Device Marking (4/5)	Samples
TPS73625DBVT	ACTIVE	SOT-23	DBV	5	250	Green (RoHS & no Sb/Br)	NIPDAU	Level-1-260C-UNLIM	-40 to 125	T42	<a href="#">Samples</a>
TPS73625DBVTG4	ACTIVE	SOT-23	DBV	5	250	Green (RoHS & no Sb/Br)	NIPDAU	Level-1-260C-UNLIM	-40 to 125	T42	<a href="#">Samples</a>
TPS73625DCQ	ACTIVE	SOT-223	DCQ	6	78	Green (RoHS & no Sb/Br)	NIPDAU	Level-2-260C-1 YEAR	-40 to 125	PS73625	<a href="#">Samples</a>
TPS73625DCQR	ACTIVE	SOT-223	DCQ	6	2500	Green (RoHS & no Sb/Br)	SN	Level-2-260C-1 YEAR	-40 to 125	PS73625	<a href="#">Samples</a>
TPS73630DBVR	ACTIVE	SOT-23	DBV	5	3000	Green (RoHS & no Sb/Br)	NIPDAU	Level-1-260C-UNLIM	-40 to 125	T45	<a href="#">Samples</a>
TPS73630DBVRG4	ACTIVE	SOT-23	DBV	5	3000	Green (RoHS & no Sb/Br)	NIPDAU	Level-1-260C-UNLIM	-40 to 125	T45	<a href="#">Samples</a>
TPS73630DBVT	ACTIVE	SOT-23	DBV	5	250	Green (RoHS & no Sb/Br)	NIPDAU	Level-1-260C-UNLIM	-40 to 125	T45	<a href="#">Samples</a>
TPS73630DBVTG4	ACTIVE	SOT-23	DBV	5	250	Green (RoHS & no Sb/Br)	NIPDAU	Level-1-260C-UNLIM	-40 to 125	T45	<a href="#">Samples</a>
TPS73630DCQ	ACTIVE	SOT-223	DCQ	6	78	Green (RoHS & no Sb/Br)	NIPDAU	Level-2-260C-1 YEAR	-40 to 125	PS73630	<a href="#">Samples</a>
TPS73630DCQG4	ACTIVE	SOT-223	DCQ	6	78	Green (RoHS & no Sb/Br)	NIPDAU	Level-2-260C-1 YEAR	-40 to 125	PS73630	<a href="#">Samples</a>
TPS73630DCQR	ACTIVE	SOT-223	DCQ	6	2500	Green (RoHS & no Sb/Br)	NIPDAU	Level-2-260C-1 YEAR	-40 to 125	PS73630	<a href="#">Samples</a>
TPS73632DBVR	ACTIVE	SOT-23	DBV	5	3000	Green (RoHS & no Sb/Br)	NIPDAU	Level-1-260C-UNLIM	-40 to 125	T53	<a href="#">Samples</a>
TPS73632DBVT	ACTIVE	SOT-23	DBV	5	250	Green (RoHS & no Sb/Br)	NIPDAU	Level-1-260C-UNLIM	-40 to 125	T53	<a href="#">Samples</a>
TPS73633DBVR	ACTIVE	SOT-23	DBV	5	3000	Green (RoHS & no Sb/Br)	NIPDAU	Level-1-260C-UNLIM	-40 to 125	T46	<a href="#">Samples</a>
TPS73633DBVRG4	ACTIVE	SOT-23	DBV	5	3000	Green (RoHS & no Sb/Br)	NIPDAU	Level-1-260C-UNLIM	-40 to 125	T46	<a href="#">Samples</a>
TPS73633DBVT	ACTIVE	SOT-23	DBV	5	250	Green (RoHS & no Sb/Br)	NIPDAU	Level-1-260C-UNLIM	-40 to 125	T46	<a href="#">Samples</a>
TPS73633DBVTG4	ACTIVE	SOT-23	DBV	5	250	Green (RoHS & no Sb/Br)	NIPDAU	Level-1-260C-UNLIM	-40 to 125	T46	<a href="#">Samples</a>
TPS73633DCQ	ACTIVE	SOT-223	DCQ	6	78	Green (RoHS & no Sb/Br)	NIPDAU	Level-2-260C-1 YEAR	-40 to 125	PS73633	<a href="#">Samples</a>

Orderable Device	Status (1)	Package Type	Package Drawing	Pins	Package Qty	Eco Plan (2)	Lead/Ball Finish (6)	MSL Peak Temp (3)	Op Temp (°C)	Device Marking (4/5)	Samples
TPS73633DCQR	ACTIVE	SOT-223	DCQ	6	2500	Green (RoHS & no Sb/Br)	NIPDAU	Level-2-260C-1 YEAR	-40 to 125	PS73633	<a href="#">Samples</a>
TPS73633DRBR	ACTIVE	SON	DRB	8	3000	Green (RoHS & no Sb/Br)	NIPDAU	Level-2-260C-1 YEAR	-40 to 125	T46	<a href="#">Samples</a>
TPS73633DRBRG4	ACTIVE	SON	DRB	8	3000	Green (RoHS & no Sb/Br)	NIPDAU	Level-2-260C-1 YEAR	-40 to 125	T46	<a href="#">Samples</a>
TPS73633DRBT	ACTIVE	SON	DRB	8	250	Green (RoHS & no Sb/Br)	NIPDAU	Level-2-260C-1 YEAR	-40 to 125	T46	<a href="#">Samples</a>
TPS73633DRBTG4	ACTIVE	SON	DRB	8	250	Green (RoHS & no Sb/Br)	NIPDAU	Level-2-260C-1 YEAR	-40 to 125	T46	<a href="#">Samples</a>
TPS73643DBVR	ACTIVE	SOT-23	DBV	5	3000	Green (RoHS & no Sb/Br)	NIPDAU	Level-1-260C-UNLIM	-40 to 125	T54	<a href="#">Samples</a>
TPS73643DBVRG4	ACTIVE	SOT-23	DBV	5	3000	Green (RoHS & no Sb/Br)	NIPDAU	Level-1-260C-UNLIM	-40 to 125	T54	<a href="#">Samples</a>
TPS73643DBVT	ACTIVE	SOT-23	DBV	5	250	Green (RoHS & no Sb/Br)	NIPDAU	Level-1-260C-UNLIM	-40 to 125	T54	<a href="#">Samples</a>

(1) The marketing status values are defined as follows:

**ACTIVE:** Product device recommended for new designs.

**LIFEBUY:** TI has announced that the device will be discontinued, and a lifetime-buy period is in effect.

**NRND:** Not recommended for new designs. Device is in production to support existing customers, but TI does not recommend using this part in a new design.

**PREVIEW:** Device has been announced but is not in production. Samples may or may not be available.

**OBSELETE:** TI has discontinued the production of the device.

(2) **RoHS:** TI defines "RoHS" to mean semiconductor products that are compliant with the current EU RoHS requirements for all 10 RoHS substances, including the requirement that RoHS substance do not exceed 0.1% by weight in homogeneous materials. Where designed to be soldered at high temperatures, "RoHS" products are suitable for use in specified lead-free processes. TI may reference these types of products as "Pb-Free".

**RoHS Exempt:** TI defines "RoHS Exempt" to mean products that contain lead but are compliant with EU RoHS pursuant to a specific EU RoHS exemption.

**Green:** TI defines "Green" to mean the content of Chlorine (Cl) and Bromine (Br) based flame retardants meet JS709B low halogen requirements of <=1000ppm threshold. Antimony trioxide based flame retardants must also meet the <=1000ppm threshold requirement.

(3) MSL, Peak Temp. - The Moisture Sensitivity Level rating according to the JEDEC industry standard classifications, and peak solder temperature.

(4) There may be additional marking, which relates to the logo, the lot trace code information, or the environmental category on the device.

(5) Multiple Device Markings will be inside parentheses. Only one Device Marking contained in parentheses and separated by a "~" will appear on a device. If a line is indented then it is a continuation of the previous line and the two combined represent the entire Device Marking for that device.

<sup>(6)</sup> Lead/Ball Finish - Orderable Devices may have multiple material finish options. Finish options are separated by a vertical ruled line. Lead/Ball Finish values may wrap to two lines if the finish value exceeds the maximum column width.

**Important Information and Disclaimer:**The information provided on this page represents TI's knowledge and belief as of the date that it is provided. TI bases its knowledge and belief on information provided by third parties, and makes no representation or warranty as to the accuracy of such information. Efforts are underway to better integrate information from third parties. TI has taken and continues to take reasonable steps to provide representative and accurate information but may not have conducted destructive testing or chemical analysis on incoming materials and chemicals. TI and TI suppliers consider certain information to be proprietary, and thus CAS numbers and other limited information may not be available for release.

In no event shall TI's liability arising out of such information exceed the total purchase price of the TI part(s) at issue in this document sold by TI to Customer on an annual basis.

**OTHER QUALIFIED VERSIONS OF TPS736 :**

- Automotive: [TPS736-Q1](#)

NOTE: Qualified Version Definitions:

- Automotive - Q100 devices qualified for high-reliability automotive applications targeting zero defects

## TAPE AND REEL INFORMATION



### QUADRANT ASSIGNMENTS FOR PIN 1 ORIENTATION IN TAPE



\*All dimensions are nominal

Device	Package Type	Package Drawing	Pins	SPQ	Reel Diameter (mm)	Reel Width W1 (mm)	A0 (mm)	B0 (mm)	K0 (mm)	P1 (mm)	W (mm)	Pin1 Quadrant
TPS73601DBVR	SOT-23	DBV	5	3000	178.0	9.0	3.23	3.17	1.37	4.0	8.0	Q3
TPS73601DBVT	SOT-23	DBV	5	250	178.0	9.0	3.3	3.2	1.4	4.0	8.0	Q3
TPS73601DCQR	SOT-223	DCQ	6	2500	330.0	12.4	7.1	7.45	1.88	8.0	12.0	Q3
TPS73601DCQRG4	SOT-223	DCQ	6	2500	330.0	12.4	7.1	7.45	1.88	8.0	12.0	Q3
TPS73601DRBR	SON	DRB	8	3000	330.0	12.4	3.3	3.3	1.1	8.0	12.0	Q2
TPS73601DRBT	SON	DRB	8	250	180.0	12.4	3.3	3.3	1.1	8.0	12.0	Q2
TPS736125DRBR	SON	DRB	8	3000	330.0	12.4	3.3	3.3	1.1	8.0	12.0	Q2
TPS736125DRBT	SON	DRB	8	250	180.0	12.4	3.3	3.3	1.1	8.0	12.0	Q2
TPS73615DBVR	SOT-23	DBV	5	3000	178.0	9.0	3.3	3.2	1.4	4.0	8.0	Q3
TPS73615DBVT	SOT-23	DBV	5	250	178.0	9.0	3.23	3.17	1.37	4.0	8.0	Q3
TPS73615DCQR	SOT-223	DCQ	6	2500	330.0	12.4	7.1	7.45	1.88	8.0	12.0	Q3
TPS73615DCQRG4	SOT-223	DCQ	6	2500	330.0	12.4	7.1	7.45	1.88	8.0	12.0	Q3
TPS73615DRBR	SON	DRB	8	3000	330.0	12.4	3.3	3.3	1.1	8.0	12.0	Q2
TPS73615DRBT	SON	DRB	8	250	180.0	12.4	3.3	3.3	1.1	8.0	12.0	Q2
TPS73616DBVR	SOT-23	DBV	5	3000	179.0	8.4	3.2	3.2	1.4	4.0	8.0	Q3
TPS73616DBVT	SOT-23	DBV	5	250	179.0	8.4	3.2	3.2	1.4	4.0	8.0	Q3
TPS73618DBVR	SOT-23	DBV	5	3000	178.0	9.0	3.23	3.17	1.37	4.0	8.0	Q3
TPS73618DBVT	SOT-23	DBV	5	250	178.0	9.0	3.23	3.17	1.37	4.0	8.0	Q3

Device	Package Type	Package Drawing	Pins	SPQ	Reel Diameter (mm)	Reel Width W1 (mm)	A0 (mm)	B0 (mm)	K0 (mm)	P1 (mm)	W (mm)	Pin1 Quadrant
TPS73618DCQR	SOT-223	DCQ	6	2500	330.0	12.4	7.1	7.45	1.88	8.0	12.0	Q3
TPS73618DCQRG4	SOT-223	DCQ	6	2500	330.0	12.4	7.1	7.45	1.88	8.0	12.0	Q3
TPS73619DRBR	SON	DRB	8	3000	330.0	12.4	3.3	3.3	1.0	8.0	12.0	Q2
TPS73619DRBT	SON	DRB	8	250	180.0	12.4	3.3	3.3	1.0	8.0	12.0	Q2
TPS73625DBVR	SOT-23	DBV	5	3000	178.0	9.0	3.23	3.17	1.37	4.0	8.0	Q3
TPS73625DBVR	SOT-23	DBV	5	3000	180.0	8.4	3.2	3.2	1.4	4.0	8.0	Q3
TPS73625DBVT	SOT-23	DBV	5	250	178.0	9.0	3.23	3.17	1.37	4.0	8.0	Q3
TPS73625DBVT	SOT-23	DBV	5	250	180.0	8.4	3.2	3.2	1.4	4.0	8.0	Q3
TPS73625DCQR	SOT-223	DCQ	6	2500	330.0	12.4	7.1	7.45	1.88	8.0	12.0	Q3
TPS73630DBVR	SOT-23	DBV	5	3000	178.0	9.0	3.23	3.17	1.37	4.0	8.0	Q3
TPS73630DBVT	SOT-23	DBV	5	250	178.0	9.0	3.23	3.17	1.37	4.0	8.0	Q3
TPS73630DCQR	SOT-223	DCQ	6	2500	330.0	12.4	7.1	7.45	1.88	8.0	12.0	Q3
TPS73632DBVR	SOT-23	DBV	5	3000	178.0	9.0	3.23	3.17	1.37	4.0	8.0	Q3
TPS73632DBVT	SOT-23	DBV	5	250	178.0	9.0	3.3	3.2	1.4	4.0	8.0	Q3
TPS73633DBVR	SOT-23	DBV	5	3000	178.0	9.0	3.23	3.17	1.37	4.0	8.0	Q3
TPS73633DBVT	SOT-23	DBV	5	250	178.0	9.0	3.23	3.17	1.37	4.0	8.0	Q3
TPS73633DCQR	SOT-223	DCQ	6	2500	330.0	12.4	7.1	7.45	1.88	8.0	12.0	Q3
TPS73633DRBR	SON	DRB	8	3000	330.0	12.4	3.3	3.3	1.1	8.0	12.0	Q2
TPS73633DRBT	SON	DRB	8	250	180.0	12.4	3.3	3.3	1.1	8.0	12.0	Q2
TPS73643DBVR	SOT-23	DBV	5	3000	180.0	8.4	3.2	3.2	1.4	4.0	8.0	Q3
TPS73643DBVT	SOT-23	DBV	5	250	179.0	8.4	3.2	3.2	1.4	4.0	8.0	Q3

**TAPE AND REEL BOX DIMENSIONS**

\*All dimensions are nominal

Device	Package Type	Package Drawing	Pins	SPQ	Length (mm)	Width (mm)	Height (mm)
TPS73601DBVR	SOT-23	DBV	5	3000	180.0	180.0	18.0
TPS73601DBVT	SOT-23	DBV	5	250	180.0	180.0	18.0
TPS73601DCQR	SOT-223	DCQ	6	2500	367.0	367.0	35.0
TPS73601DCQRG4	SOT-223	DCQ	6	2500	346.0	346.0	29.0
TPS73601DRBR	SON	DRB	8	3000	367.0	367.0	35.0
TPS73601DRBT	SON	DRB	8	250	210.0	185.0	35.0
TPS736125DRBR	SON	DRB	8	3000	367.0	367.0	35.0
TPS736125DRBT	SON	DRB	8	250	210.0	185.0	35.0
TPS73615DBVR	SOT-23	DBV	5	3000	180.0	180.0	18.0
TPS73615DBVT	SOT-23	DBV	5	250	180.0	180.0	18.0
TPS73615DCQR	SOT-223	DCQ	6	2500	367.0	367.0	35.0
TPS73615DCQRG4	SOT-223	DCQ	6	2500	346.0	346.0	29.0
TPS73615DRBR	SON	DRB	8	3000	367.0	367.0	35.0
TPS73615DRBT	SON	DRB	8	250	210.0	185.0	35.0
TPS73616DBVR	SOT-23	DBV	5	3000	203.0	203.0	35.0
TPS73616DBVT	SOT-23	DBV	5	250	203.0	203.0	35.0
TPS73618DBVR	SOT-23	DBV	5	3000	180.0	180.0	18.0
TPS73618DBVT	SOT-23	DBV	5	250	180.0	180.0	18.0
TPS73618DCQR	SOT-223	DCQ	6	2500	367.0	367.0	35.0
TPS73618DCQRG4	SOT-223	DCQ	6	2500	346.0	346.0	41.0

Device	Package Type	Package Drawing	Pins	SPQ	Length (mm)	Width (mm)	Height (mm)
TPS73619DRBR	SON	DRB	8	3000	370.0	355.0	55.0
TPS73619DRBT	SON	DRB	8	250	220.0	205.0	50.0
TPS73625DBVR	SOT-23	DBV	5	3000	180.0	180.0	18.0
TPS73625DBVR	SOT-23	DBV	5	3000	203.0	203.0	35.0
TPS73625DBVT	SOT-23	DBV	5	250	180.0	180.0	18.0
TPS73625DBVT	SOT-23	DBV	5	250	203.0	203.0	35.0
TPS73625DCQR	SOT-223	DCQ	6	2500	367.0	367.0	35.0
TPS73630DBVR	SOT-23	DBV	5	3000	180.0	180.0	18.0
TPS73630DBVT	SOT-23	DBV	5	250	180.0	180.0	18.0
TPS73630DCQR	SOT-223	DCQ	6	2500	346.0	346.0	41.0
TPS73632DBVR	SOT-23	DBV	5	3000	180.0	180.0	18.0
TPS73632DBVT	SOT-23	DBV	5	250	180.0	180.0	18.0
TPS73633DBVR	SOT-23	DBV	5	3000	180.0	180.0	18.0
TPS73633DBVT	SOT-23	DBV	5	250	180.0	180.0	18.0
TPS73633DCQR	SOT-223	DCQ	6	2500	346.0	346.0	41.0
TPS73633DRBR	SON	DRB	8	3000	367.0	367.0	35.0
TPS73633DRBT	SON	DRB	8	250	210.0	185.0	35.0
TPS73643DBVR	SOT-23	DBV	5	3000	203.0	203.0	35.0
TPS73643DBVT	SOT-23	DBV	5	250	203.0	203.0	35.0



DCQ (R-PDSO-G6)

PLASTIC SMALL-OUTLINE

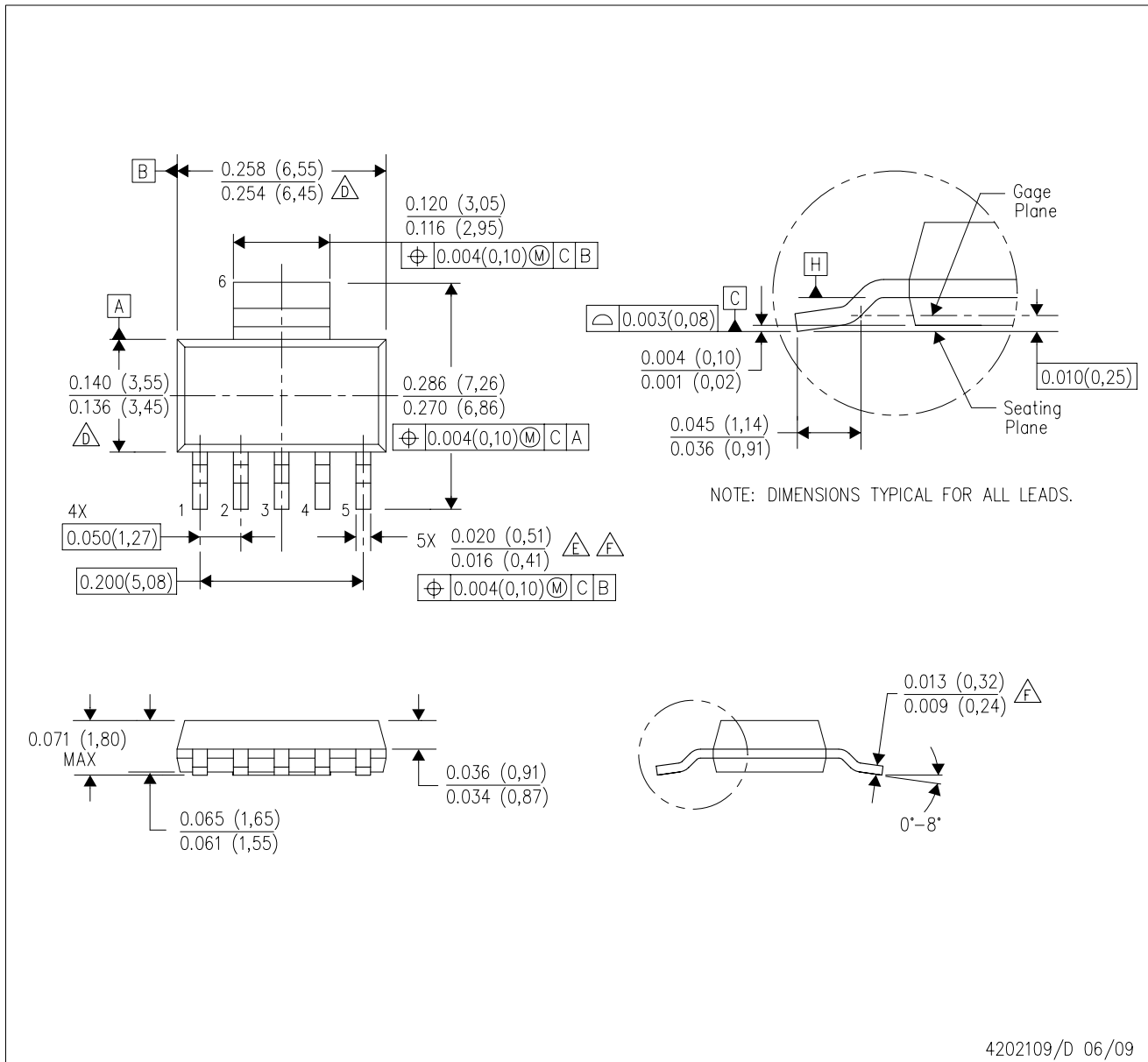

4202109/D 06/09

- NOTES:
- A. All linear dimensions are in inches (millimeters).
  - B. This drawing is subject to change without notice.
  - C. Controlling dimension in inches.
  - $\triangle D$  Body length and width dimensions are determined at the outermost extremes of the plastic body exclusive of mold flash, tie bar burrs, gate burrs, and interlead flash, but including any mismatch between the top and the bottom of the plastic body.
  - $\triangle E$  Lead width dimension does not include dambar protrusion.
  - $\triangle F$  Lead width and thickness dimensions apply to solder plated leads.
  - G. Interlead flash allow 0.008 inch max.
  - H. Gate burr/protrusion max. 0.006 inch.
  - I. Datums A and B are to be determined at Datum H.

DCQ (R-PDSO-G6)

PLASTIC SMALL OUTLINE

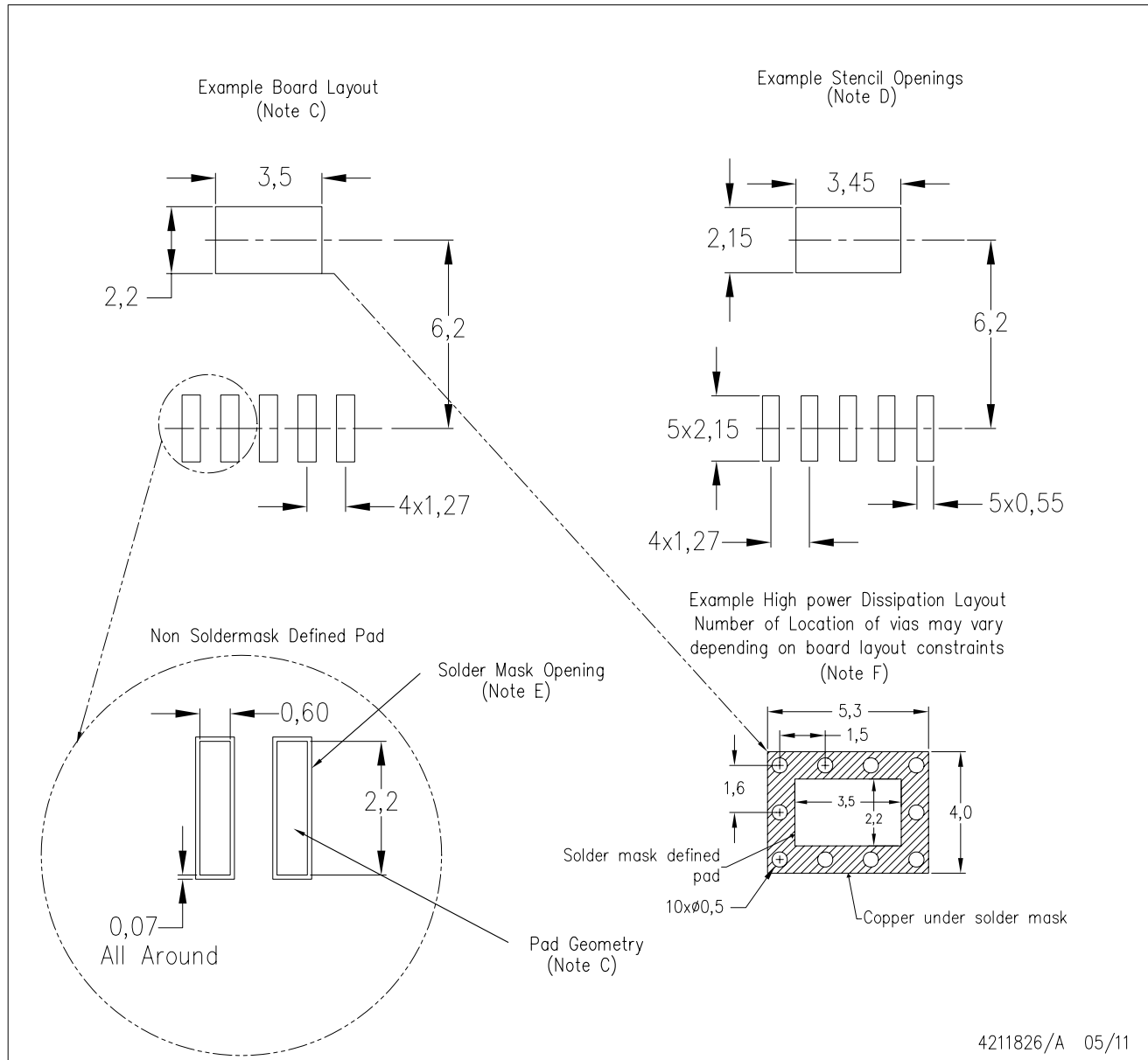

- NOTES:
- All linear dimensions are in millimeters.
  - This drawing is subject to change without notice.
  - Publication IPC-SM-782 is recommended for alternate designs.
  - Laser cutting apertures with trapezoidal walls and also rounding corners will offer better paste release. Customers should contact their board assembly site for stencil design recommendations.
  - Customers should contact their board fabrication site for solder mask tolerances between and around signal pads.
  - Please refer to the product data sheet for specific via and thermal dissipation requirements.

**DRB 8**

**GENERIC PACKAGE VIEW**

**VSON - 1 mm max height**

PLASTIC SMALL OUTLINE - NO LEAD

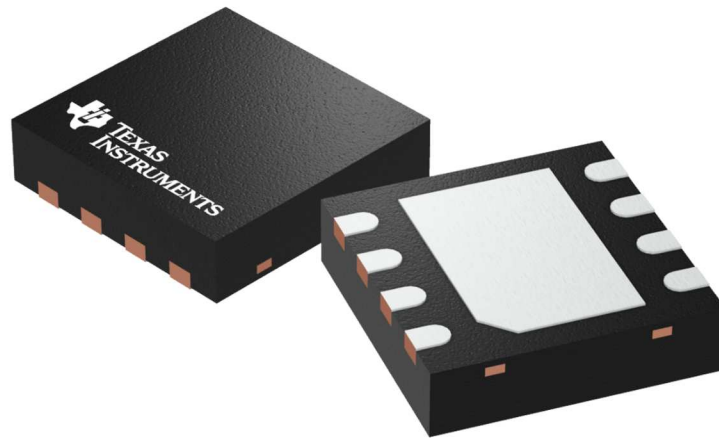

Images above are just a representation of the package family, actual package may vary.  
Refer to the product data sheet for package details.

4203482/L



# EXAMPLE BOARD LAYOUT

DRB0008A

VSON - 1 mm max height

PLASTIC SMALL OUTLINE - NO LEAD



LAND PATTERN EXAMPLE  
EXPOSED METAL SHOWN  
SCALE:20X

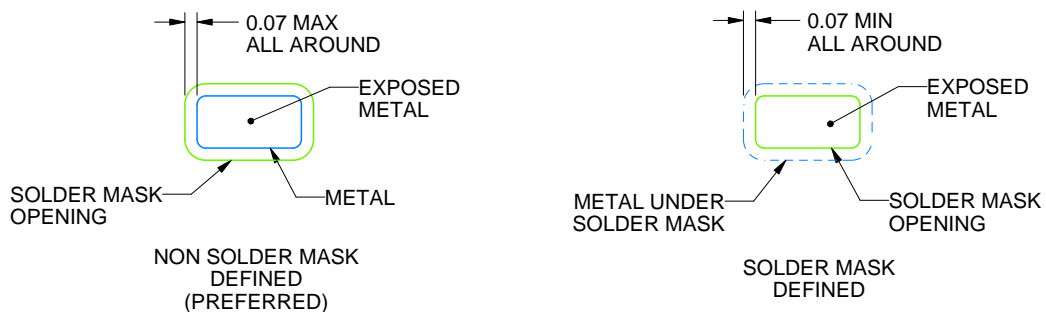

SOLDER MASK DETAILS

4218875/A 01/2018

NOTES: (continued)

4. This package is designed to be soldered to a thermal pad on the board. For more information, see Texas Instruments literature number SLUA271 ([www.ti.com/lit/slue271](http://www.ti.com/lit/slue271)).
5. Vias are optional depending on application, refer to device data sheet. If any vias are implemented, refer to their locations shown on this view. It is recommended that vias under paste be filled, plugged or tented.

# EXAMPLE STENCIL DESIGN

DRB0008A

VSON - 1 mm max height

PLASTIC SMALL OUTLINE - NO LEAD



SOLDER PASTE EXAMPLE  
BASED ON 0.125 mm THICK STENCIL

EXPOSED PAD  
84% PRINTED SOLDER COVERAGE BY AREA  
SCALE:25X

4218875/A 01/2018

NOTES: (continued)

6. Laser cutting apertures with trapezoidal walls and rounded corners may offer better paste release. IPC-7525 may have alternate design recommendations.



# EXAMPLE BOARD LAYOUT

DBV0005A

SOT-23 - 1.45 mm max height

SMALL OUTLINE TRANSISTOR



LAND PATTERN EXAMPLE  
EXPOSED METAL SHOWN  
SCALE:15X



SOLDER MASK DETAILS

4214839/E 09/2019

NOTES: (continued)

- 5. Publication IPC-7351 may have alternate designs.
- 6. Solder mask tolerances between and around signal pads can vary based on board fabrication site.



# EXAMPLE STENCIL DESIGN

DBV0005A

SOT-23 - 1.45 mm max height

SMALL OUTLINE TRANSISTOR



SOLDER PASTE EXAMPLE  
BASED ON 0.125 mm THICK STENCIL  
SCALE:15X

4214839/E 09/2019

NOTES: (continued)

7. Laser cutting apertures with trapezoidal walls and rounded corners may offer better paste release. IPC-7525 may have alternate design recommendations.
8. Board assembly site may have different recommendations for stencil design.

## IMPORTANT NOTICE AND DISCLAIMER

TI PROVIDES TECHNICAL AND RELIABILITY DATA (INCLUDING DATASHEETS), DESIGN RESOURCES (INCLUDING REFERENCE DESIGNS), APPLICATION OR OTHER DESIGN ADVICE, WEB TOOLS, SAFETY INFORMATION, AND OTHER RESOURCES "AS IS" AND WITH ALL FAULTS, AND DISCLAIMS ALL WARRANTIES, EXPRESS AND IMPLIED, INCLUDING WITHOUT LIMITATION ANY IMPLIED WARRANTIES OF MERCHANTABILITY, FITNESS FOR A PARTICULAR PURPOSE OR NON-INFRINGEMENT OF THIRD PARTY INTELLECTUAL PROPERTY RIGHTS.

These resources are intended for skilled developers designing with TI products. You are solely responsible for (1) selecting the appropriate TI products for your application, (2) designing, validating and testing your application, and (3) ensuring your application meets applicable standards, and any other safety, security, or other requirements. These resources are subject to change without notice. TI grants you permission to use these resources only for development of an application that uses the TI products described in the resource. Other reproduction and display of these resources is prohibited. No license is granted to any other TI intellectual property right or to any third party intellectual property right. TI disclaims responsibility for, and you will fully indemnify TI and its representatives against, any claims, damages, costs, losses, and liabilities arising out of your use of these resources.

TI's products are provided subject to TI's Terms of Sale ([www.ti.com/legal/termsofsale.html](http://www.ti.com/legal/termsofsale.html)) or other applicable terms available either on [ti.com](http://ti.com) or provided in conjunction with such TI products. TI's provision of these resources does not expand or otherwise alter TI's applicable warranties or warranty disclaimers for TI products.

Mailing Address: Texas Instruments, Post Office Box 655303, Dallas, Texas 75265  
Copyright © 2020, Texas Instruments Incorporated