

REV	ECN	APP'D
-	3750	JEC 5/3/99
A	3893	JEC 1/6/00
B	3677	
C	6031	PJC 3-06-07
D	6138	PJC 10-22-07
E	6188	PJC 2-26-08

FXP SERIES PART NUMBERING SCHEME

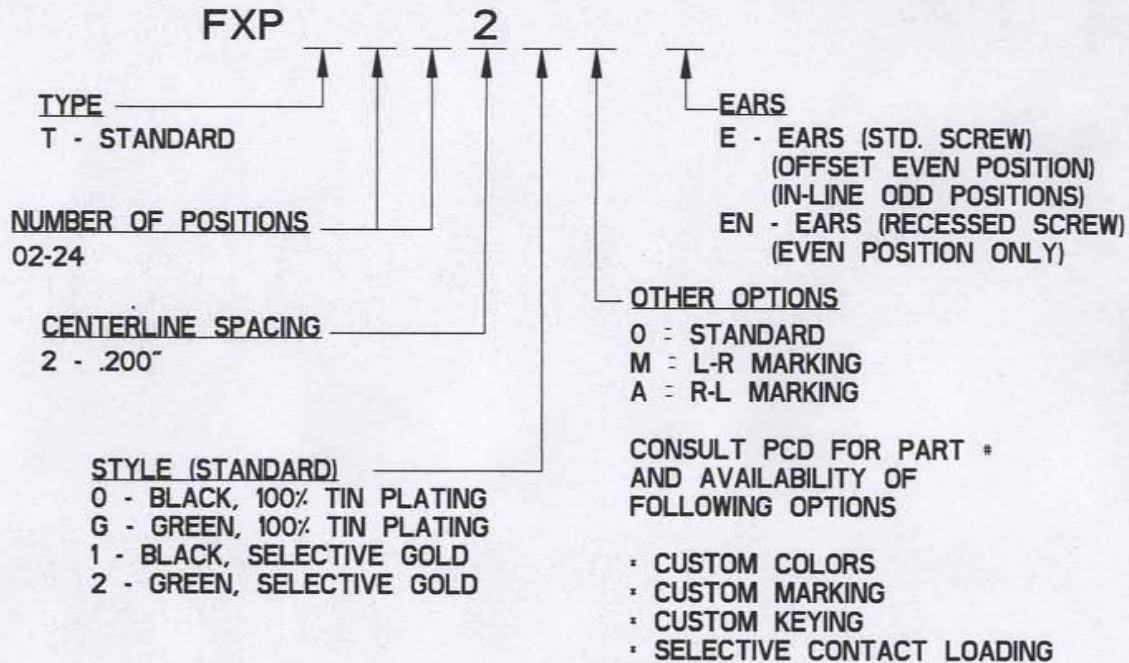

# POS	DIM "A"
2	.40
3	.60
4	.80
5	1.00
6	1.20
7	1.40
8	1.60
9	1.80
10	2.00
11	2.20
12	2.40
13	2.60
14	2.80
15	3.00
16	3.20
17	3.40
18	3.60
19	3.80
20	4.00
21	4.20
22	4.40
23	4.60
24	4.80



RATINGS

CURRENT - 15A
VOLTAGE - 300V
U.L. FILE NO. E83421



RATINGS

CURRENT - 15A
VOLTAGE - 300V
CSA FILE NO. LR69703

DIN VDE 0627:1986
DIN VDE 0110-1:1989
EN 60947-1:1991
EN 60947-7-1:1992

CURRENT - PENDING
VOLTAGE - PENDING
TUV FILE NO. PENDING

INSTALLATION RECOMMENDATIONS
WIRE RANGE: AWG #12-26, STRANDED
WIRE STRIP LENGTH: .310"
TIGHTENING TORQUE: 10 IN-LB

MATERIALS:
HOUSING: PPO, UL 94 V-0
CONTACT: COPPER ALLOY
SCREW: STEEL, NICKEL FINISH

MAX OPERATING TEMPERATURE:
105°C

DIMENSIONS

ANSI Y14.5M
UNITS: INCHES
Pro/E FILE

TOLERANCES

.XX ±0.02
.XXX ±0.010
ANGLES ±0.5°

PROJECTION



AMPHENOL PCD
SPECIFICATION DRAWING

ENGR

D. MANTER 03-May-99

CHKD

A. PATRIE 03-May-99

APPD

J. CAHALY 03-May-99

TITLE

**FXP SERIES
PLUG ASSEMBLY**

ORIGINAL

*THIS DOCUMENT CONTAINS
PROPRIETARY INFORMATION WHICH
IS THE CONFIDENTIAL PROPERTY
OF AMPHENOL PCD
PEABODY, MA, USA*

SIZE

A

DWG NO.

FXPTXX200

REV

E

CODE: 58982

SCALE: NONE

SHEET 1 OF 3

**EVEN CONFIG
W/O EARS**

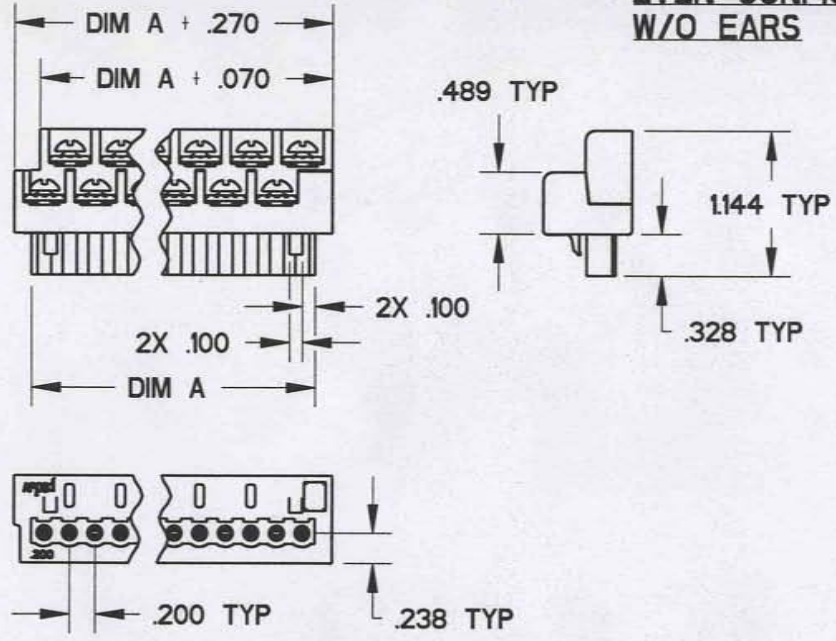

**EVEN CONFIG W/
OFFSET EARS**

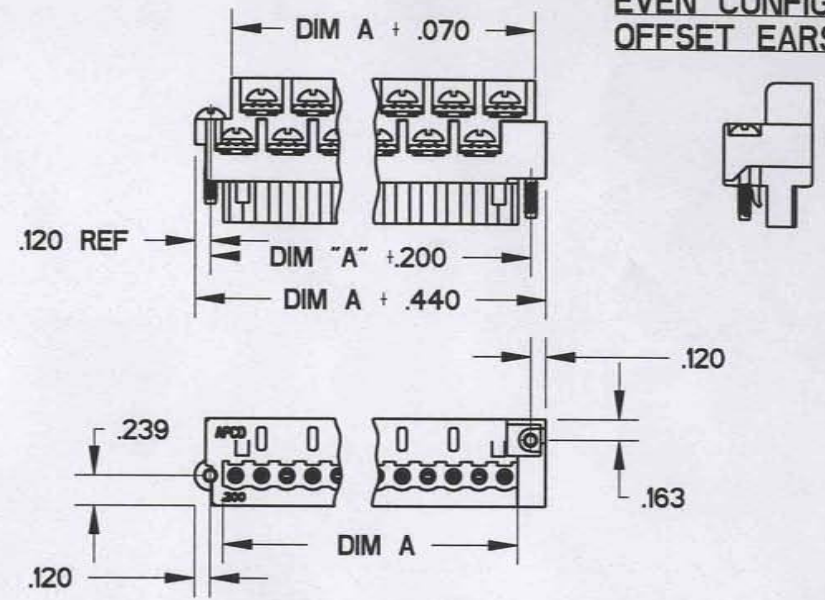

**ODD CONFIG
W/O EARS**

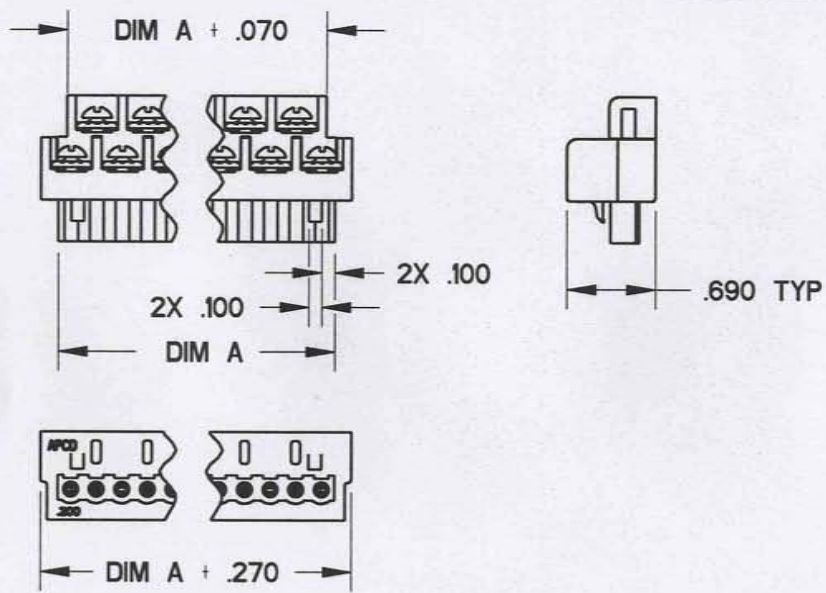

**ODD CONFIG W/
INLINE EARS**

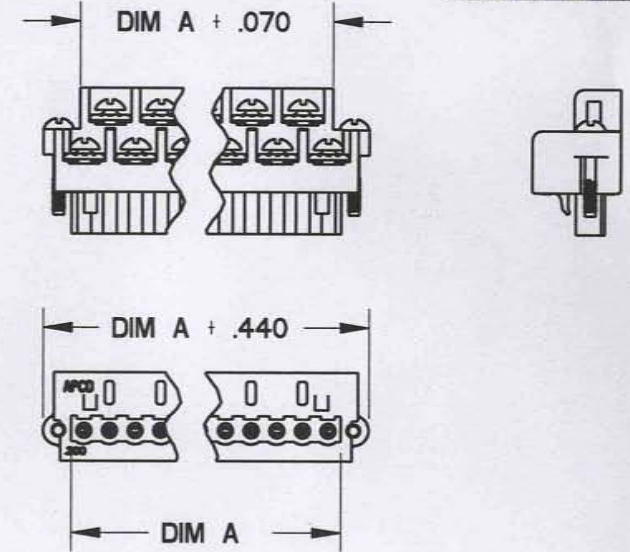

DIM A = NUM OF POS X CL SPACING

SIZE A	DWG NO. FXPTXX200	REV E
CODE: 58982	SCALE: NONE	SHEET 2 OF 3

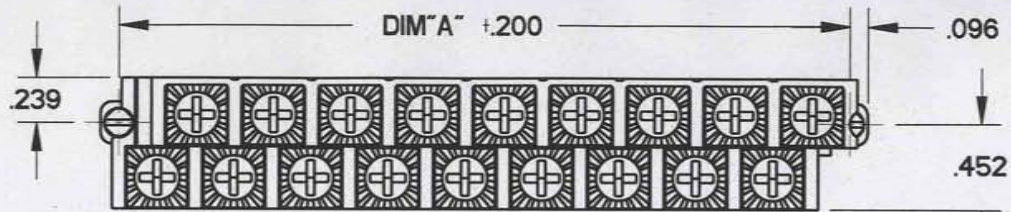

**EVEN CONFIG W/ IN-LINE EARS
& RECESSED MOUNTING SCREW**

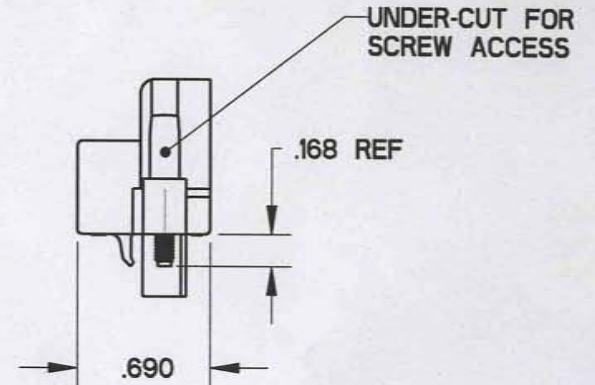
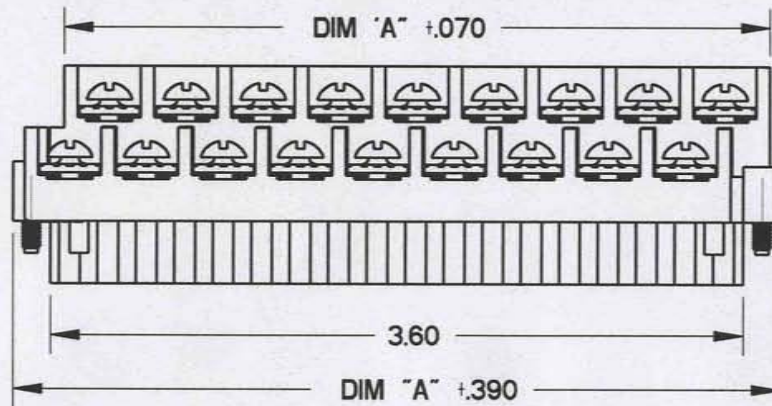

SIZE A	DWG NO. FXPTXX200	REV E
CODE: 58982	SCALE: NONE	SHEET 3 OF 3

Mouser Electronics

Authorized Distributor

Click to View Pricing, Inventory, Delivery & Lifecycle Information:

[Amphenol:](#)

[FXPT03200E](#) [FXPT03200](#) [FXPT02200](#) [FXPT11200E](#) [FXPT10200](#) [FXPT06200](#) [FXPT07200](#) [FXPT11200](#)
[FXPT09200](#) [FXPT12200](#) [FXPT05200](#) [FXPT13200E](#) [FXPT07200E](#) [FXPT05200E](#) [FXPT09200E](#) [FXPT21200E](#)