

General Specifications

Electrical Capacity (Resistive Load)

Power Level (silver): 6A @ 125V AC & 3A @ 250V AC

4A @ 30V DC for On-None-On & On-None-Off; 3A @ 30V DC for all other circuits

Logic Level (gold): 0.4VA maximum @ 28V AC/DC maximum (Applicable Range 0.1mA ~ 0.1A @ 20mV ~ 28V)

Logic/Power Level (gold over silver): Combines silver & gold ratings

Note: Find additional explanation of dual rating & operating range in Supplement section.

Other Ratings

Contact Resistance: 10 milliohms maximum for silver; 20 milliohms maximum for gold

Insulation Resistance: 1,000 megohms minimum @ 500V DC

Dielectric Strength: 1,000V AC minimum between contacts for 1 minute minimum;
1,500V AC minimum between contacts and case for 1 minute minimum

Mechanical Life: 100,000 operations minimum; 50,000 operations minimum for flat, locking & splashproof devices

Electrical Life: 25,000 operations minimum for silver; 50,000 operations minimum for gold;

50,000 operations minimum for silver at 3A @ 125V AC

Angle of Throw: 25°

Materials & Finishes

Toggle: Brass with chrome plating

Frame: Stainless steel

Bushing: Brass with nickel plating

Support Bracket: Brass with tin plating

Case: Diallyl phthalate resin (UL94V-0)

Movable Contactor: Phosphor bronze with silver or gold plating

Movable Contacts: Silver alloy (code W); copper with gold plating (code G); or silver alloy with gold plating (code A)

Stationary Contacts: Silver with silver plating (code W); copper or brass with gold plating (code G);
or silver with gold plating (code A)

Terminals: Copper or brass with silver plating; or copper or brass with gold plating

Environmental Data

Operating Temp Range: -30°C through +85°C (-22°F through +185°F)

Humidity: 90 ~ 95% humidity for 96 hours @ 40°C (104°F)

Vibration: 10 ~ 55Hz with peak-to-peak amplitude of 1.5mm traversing the frequency range & returning
in 1 minute; 3 right angled directions for 2 hours

Shock: 50G (490m/s²) acceleration (tested in 6 right angled directions, with 5 shocks in each direction)

Sealing: Splashproof bushing options B3, D3, D8, L3, & L8, which have o-rings inside & outside the
bushing, meet IP67 of IEC60529 Standards.

Installation

Mounting Torque: 3.0Nm (26.55 lb•in) double nut for large bushing;

1.5Nm (13 lb•in) double nut & 0.7Nm (6 lb•in) single nut for all other bushings

Processing

Soldering: Wave Soldering (PC version) for Gold: See Profile A in Supplement section.

Manual Soldering for Gold: See Profile A in Supplement section.

Wave Soldering (PC version) for Silver: See Profile B in Supplement section.

Manual Soldering for Silver: See Profile B in Supplement section.

Note: Lever must be in OFF (center) position while soldering.

Cleaning: These devices are not process sealed. Hand clean locally using alcohol based solution.

Standards & Certifications

Flammability Standards: UL94V-0 for case

UL: File No. E44145 - Recognized only when ordered with marking on switch.

Add "/U" or "/CUL" before dash in part number to order UL recognized switch.

All models recognized at 6A @ 125V AC, 3A @ 250V AC or 0.4VA maximum @ 28V DC maximum.

CSA: File No. 023535_0_000 - Certified only when ordered with marking on switch.

Add "/C" before dash in part number to order CSA certified switch.

All models certified at 6A @ 125V AC or 3A @ 250V AC or 0.4VA maximum @ 28V maximum.

Distinctive Characteristics

Antirotation design, standard on noncylindrical levers, mates toggle and bushing; bottom of toggle has two flattened sides which fit into a complementary opening inside bushing.

Antijamming design protects contacts from damage due to excessive downward force on actuator.

High torque bushing construction prevents rotation or separation from frame during installation.

High insulating barriers increase isolation of circuits in multipole devices and provide added protection to contact points.

Molded diallyl phthalate case has a UL flammability rating of 94V-0.

Epoxy sealed terminals prevent entry of solder flux and other contaminants.

Prominent external insulating barriers increase insulation resistance and dielectric strength.

Interlocked actuator block, lever, and interior guide prevent switch failure due to biased lever movement.

Clinching of frame to case well above base and terminals provides 1,500V dielectric strength.

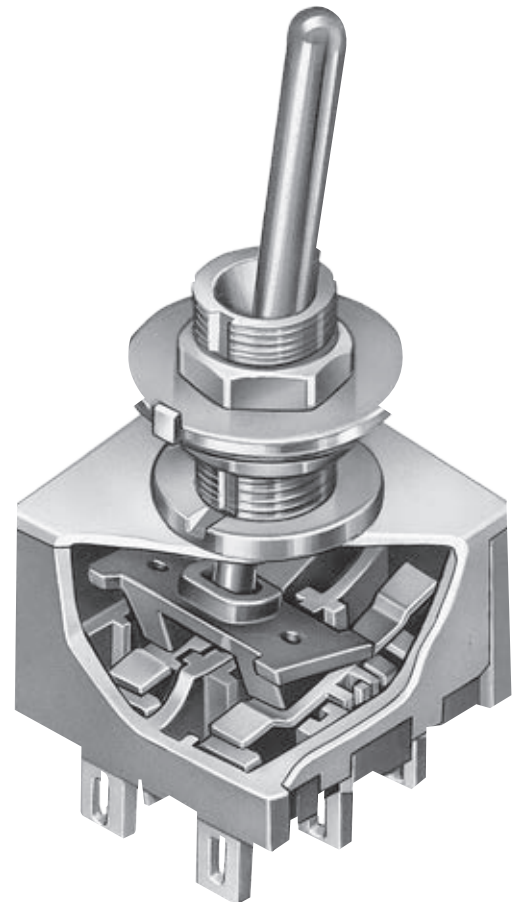

Actual Size

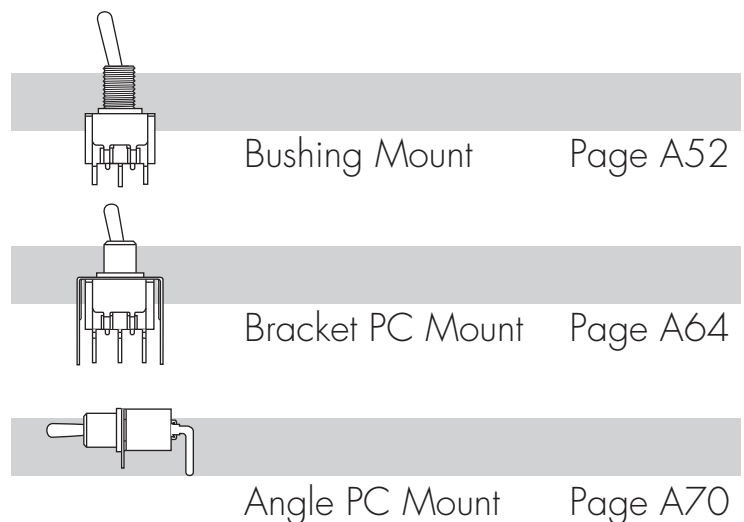

A
Toggles

Rockers

Pushbuttons

Illuminated PB

Programmable

Keylocks

Rotaries

Slides

Tactiles

Tilt

Touch

Indicators

Accessories

Supplement

M20

1

3

S

S1

Poles

| | |
|---|----------------------|
| 1 | SPST SPDT |
| 2 | DPST DPDT SP3T |
| 3 | 3PDT |
| 4 | 4PDT DP3T |

Small Toggles

| | |
|------|---|
| S | .413" (10.5mm) Bat |
| S2 | .200" (5.08mm) Bat |
| S3 | .256" (6.5mm) Bat |
| E | .450" (11.4mm) Flatted |
| * E2 | .256" (6.5mm) Flatted |
| E4 | .840" (21.3mm) Flatted |
| * Q | .550" (14.0mm) Cone |
| * Q2 | .640" (16.26mm) Cone |
| * Q4 | .840" (21.3mm) Cone |
| * C | .571" (14.5mm) Color Tipped Cone (available in colors A, B & C only) |
| D | .840" (21.3mm) Color Capped Cone |

Specify cap color for toggles C & D at the end of the part number.
* Available on 1- and 2-pole only.

Small Bushings

| | |
|----|--|
| S1 | .350" (8.9mm) Threaded with Keyway |
| S4 | 6mm .350" (8.9mm) Threaded with Keyway |
| S2 | .350" (8.9mm) Smooth with Keyway |
| A1 | .280" (7.1mm) Threaded with Keyway |
| A2 | .280" (7.1mm) Smooth with Keyway |
| D1 | .350" (8.9mm) Threaded with D Flat |
| D4 | 6mm .350" (8.9mm) Threaded with D Flat |
| D3 | .350" (8.9mm) Threaded Splashproof with D Flat (combines only with S, S2 & S3) |
| D8 | 6mm .350" (8.9mm) Threaded Splashproof with D Flat (combines only with S, S2 & S3) |

Circuits

| | | | |
|-----|------|------|------|
| * 1 | ON | NONE | OFF |
| 2 | ON | NONE | ON |
| 3 | ON | OFF | ON |
| 5 | ON | NONE | (ON) |
| 8 | (ON) | OFF | (ON) |
| 9 | ON | OFF | (ON) |
| **4 | ON | ON | ON |
| **6 | (ON) | ON | (ON) |
| **7 | ON | ON | (ON) |

() = Momentary

* ON-NONE-OFF circuit available in 1- and 2-pole only.

** 3-ON circuits

Large Toggles

| | |
|----|------------------------------|
| B | .453" (11.5mm) Large Bat |
| B2 | .689" (17.5mm) Large Bat |
| R | .610" (15.5mm) Large Flatted |

Large Bushings

| | |
|----|---|
| B1 | Large .472" (12mm) Threaded with Keyway |
| B3 | Large .472" (12mm) Threaded Splashproof with D Flat |

Locking Lever

| | |
|---|----------------------------------|
| L | .201" (5.1mm) Dia. Locking Lever |
|---|----------------------------------|

Bushings For Locking Levers

| | |
|----|---|
| L1 | .291" (7.4mm) Threaded with Keyway for Lever Lock |
| L4 | 6mm .291" (7.4mm) Threaded with Keyway for Lever Lock |
| L2 | Smooth with Keyway for Lever Lock |
| L3 | .295" (7.5mm) Threaded Splashproof with D Flat for Lever Lock |
| L8 | 6mm .295" (7.5mm) Threaded Splashproof with D Flat for Lever Lock |

IMPORTANT:



Switches are supplied without UL, cULus & CSA marking unless specified.
UL, cULus & CSA recognized only when ordered with marking on the switch.
Specific models, ratings, & ordering instructions are noted on the General Specifications page.

ORDERING EXAMPLE

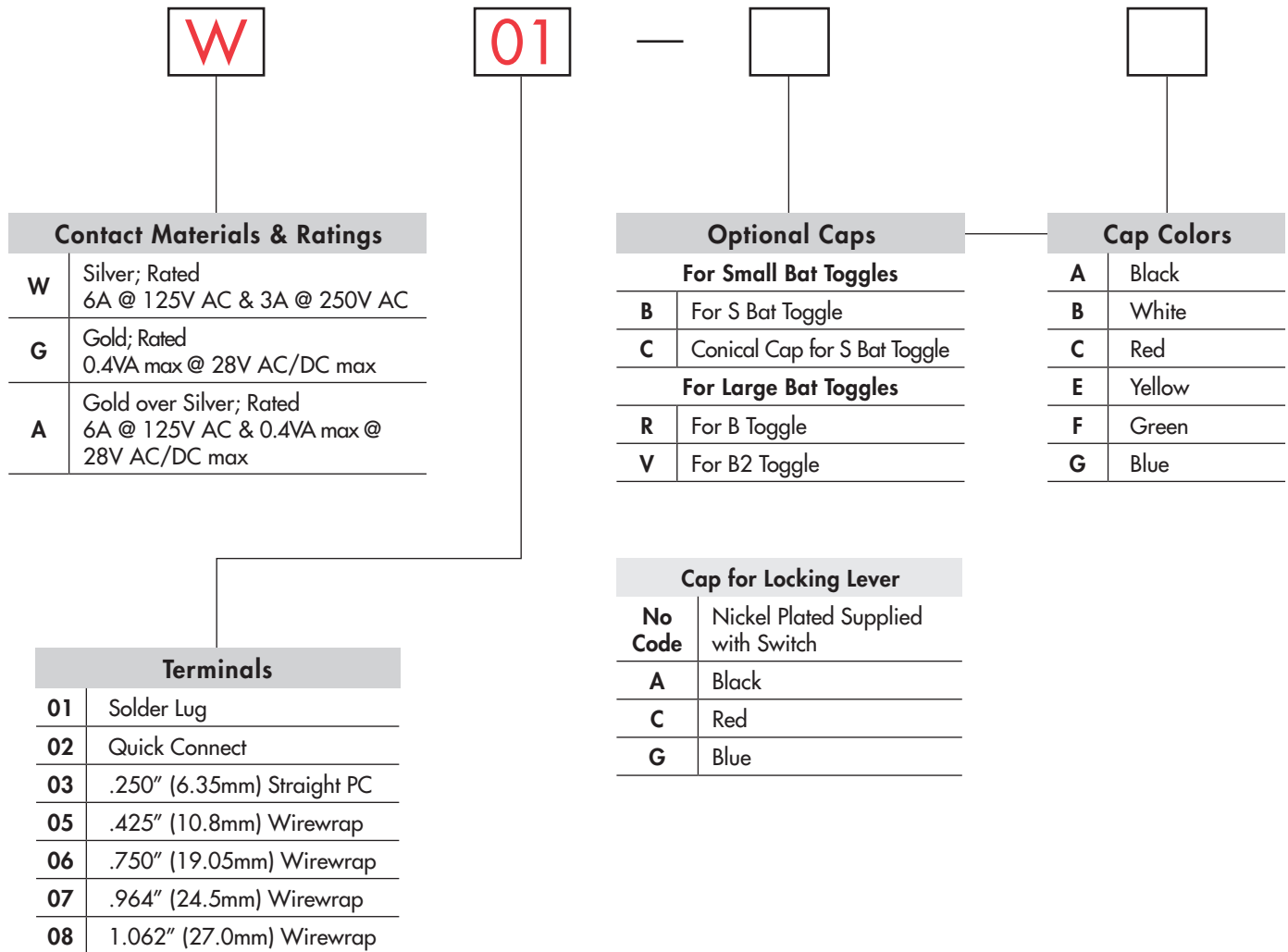

DESCRIPTION FOR TYPICAL ORDERING EXAMPLE

M2013SS1W01

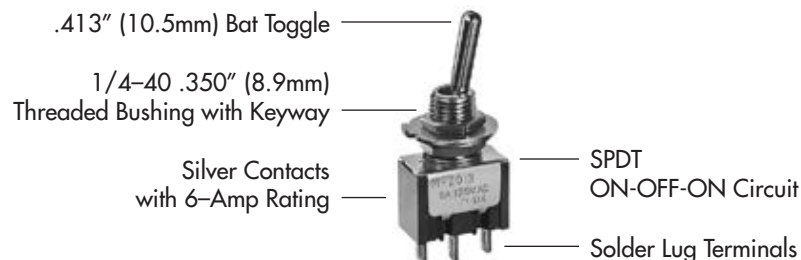

SMALL TOGGLES

S .413" (10.5mm)
Bat

S2 .200" (5.08mm)
Bat

S3 .256" (6.5mm)
Bat

Important:

Toggle length changes based on bushing selected. All illustrations are shown with .350" long bushing. When using a .280" long bushing, toggle length increases .070".

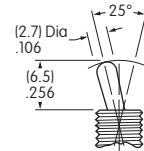
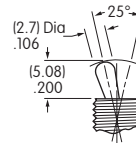
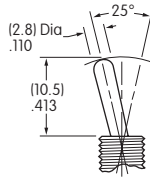

Standard Material & Finish: Brass with Bright Chrome
Contact factory for optional finishes.

E .450" (11.4mm)
Flatted

E2 .256" (6.5mm)
Flatted

E4 .840" (21.3mm)
Flatted

C .571" (14.5mm)
Color Tipped Cone
Supplied with Cap AT445

Colors: A B C
Material: Polycarbonate

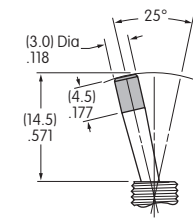
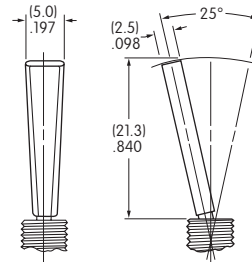
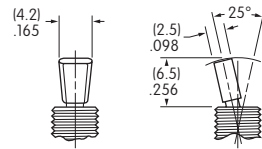
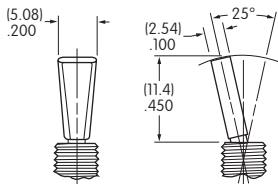

Only Available in 1- & 2-Pole

Only Available in 1- & 2-Pole

Q .550" (14.0mm)
Cone

Q2 .640" (16.26mm)
Cone

Q4 .840" (21.3mm)
Cone

D .840" (21.3mm)
Color Capped Cone
Supplied with Cap AT460

Colors: A B C E F G
Material: Polyethylene

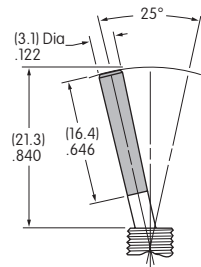
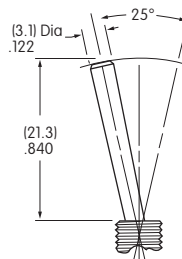
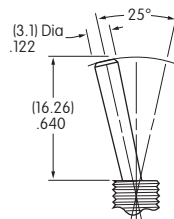
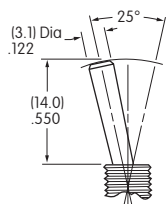

Only Available in 1- & 2-Pole

Only Available in 1- & 2-Pole

Only Available in 1- & 2-Pole

Cap Colors Available:

A Black

B White

C Red

E Yellow

F Green

G Blue

SMALL BUSHINGS

S1 1/4-40 .350" (8.9mm)
Threaded with Keyway

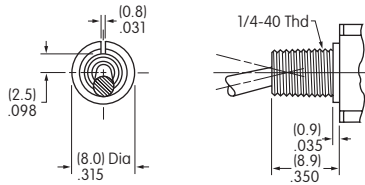

Maximum Panel Thickness with Standard Hardware: .102" (2.6mm)

S4 6mm/.350" (8.9mm)
Threaded with Keyway

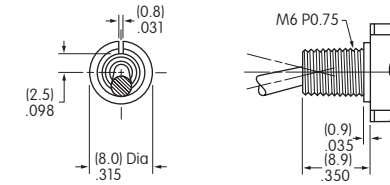

Maximum Panel Thickness with Standard Hardware: .102" (2.6mm)

S2 .350" (8.9mm)
Smooth with Keyway

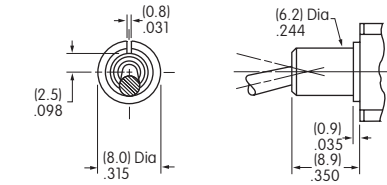

A1 1/4-40 .280" (7.1mm)
Threaded with Keyway

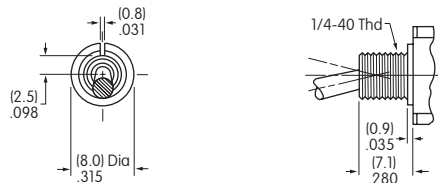

When using this bushing, toggle length is increased by .070". Maximum Panel Thickness with Standard Hardware: .031" (0.8mm)

A2 .280" (7.1mm)
Smooth with Keyway

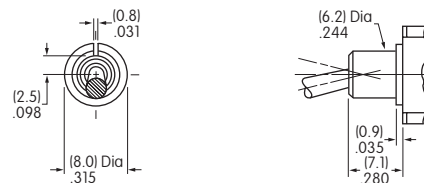

When using this bushing, toggle length is increased by .070".

D1 1/4-40 .350" (8.9mm)
Threaded with D Flat

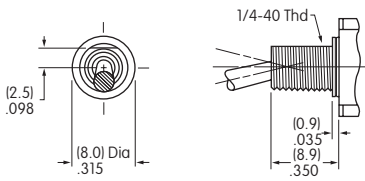

Maximum Panel Thickness with Standard Hardware: .102" (2.6mm)

D4 6mm/.350" (8.9mm)
Threaded with D Flat

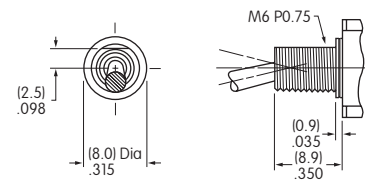

Maximum Panel Thickness with Standard Hardware: .102" (2.6mm)

D3 1/4-40 .350" (8.9mm)
Threaded Splashproof with D Flat

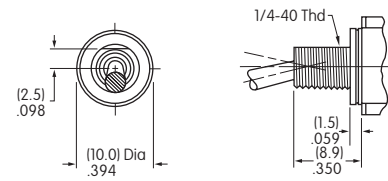

D3 combines only with S, S2 & S3 toggles. Maximum Panel Thickness with Standard Hardware: .193" (4.9mm)

D8 6mm/.350" (8.9mm)
Threaded Splashproof with D Flat

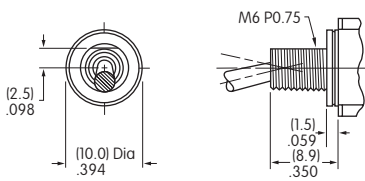

D8 combines only with S, S2 & S3 toggles. Maximum Panel Thickness with Standard Hardware: .193" (4.9mm)

Standard Hardware Supplied for Small Bushings

| Bushing Codes | S1/S4 | A1 | D1/D4 | D3/D8 | L1/L4 | L3/L8 |
|---------------|-------|----|-------|-------|-------|-------|
| Hex Nut | 2 | 2 | 2 | 1 | 2 | 1 |
| Locking Ring | 1 | 1 | 0 | 0 | 1 | 0 |
| Lockwasher | 1 | 1 | 1 | 0 | 1 | 0 |
| O-ring | 0 | 0 | 0 | 1 | 0 | 1 |

For S1, S2, A1, A2 or S4 Bushing with Keyway & for L1 or L4 Bushing

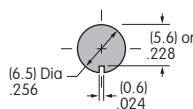

For S1, A1 or S4 Bushing with Locking Ring & for L1 or L4 Bushing

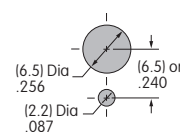

For D1, D4, D3 or D8 Bushing with D Flat & for L3 or L8 Bushing

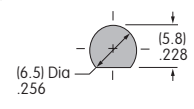

LARGE TOGGLES

Toggle & Bushing Combinations: These toggles combine with the 12mm bushings B1 & B3.

B .453" (11.5mm)
Large Bat

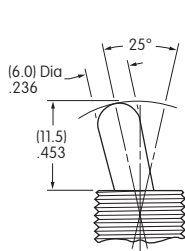

B2 .689" (17.5mm)
Large Bat

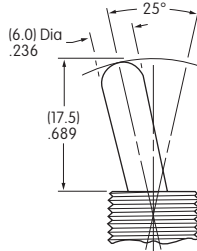

R .610" (15.5mm)
Large Flatted

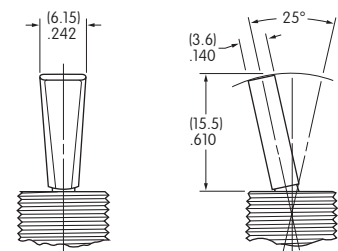

Standard Material & Finish: Brass with Bright Chrome
Optional Finishes: Contact factory for satin chrome or black.

LARGE BUSHINGS

B1 Large .472" (12.0mm)
Threaded with Keyway

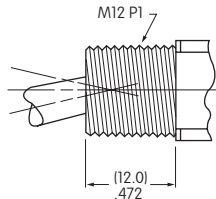
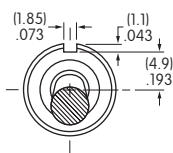

Maximum Panel Thickness with
Standard Hardware: .216" (5.5mm)

Standard Hardware for B1:
1 hex face nut AT503M, 1 locking ring AT506M,
1 lockwasher AT508, and 1 hex backup nut AT527M

B3 Large .472" (12.0mm)
Threaded Splashproof with D Flat

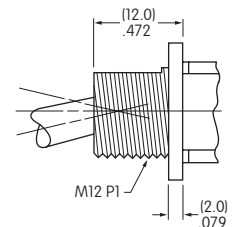
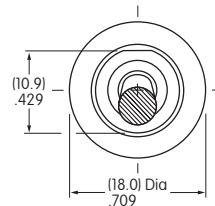

Maximum Panel Thickness with
Standard Hardware: .256" (6.5mm)

Standard Hardware for B3:
1 hex face nut AT503M
and 1 o-ring AT401P

Panel Cutouts

**For B1 Bushing
with Keyway**

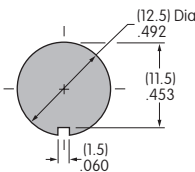

**For B1 Bushing
with Locking Ring**

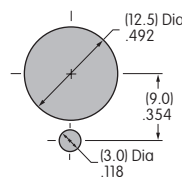

**For B3 Bushing
with D Flat**

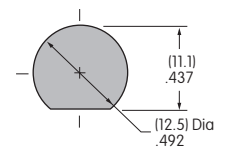

LOCKING LEVER & BUSHINGS

LL1 1/4-40 .291" (7.4mm)
Threaded with Keyway

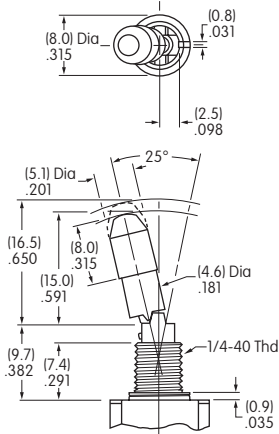

LL4 6mm/.291" (7.4mm)
Threaded with Keyway

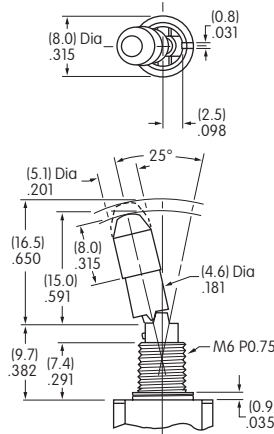

LL2 Smooth with Keyway

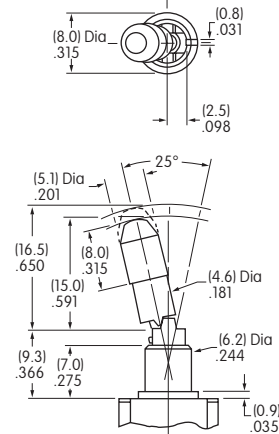

Maximum Panel Thickness with Standard Hardware: .047" (1.2mm)
Standard Hardware for L1 & L4: 2 hex nuts AT513H or AT513M,
1 locking ring AT507H or AT507M, and 1 lockwasher AT509

LL3 1/4-40 .295" (7.5mm)
Threaded Splashproof with D Flat

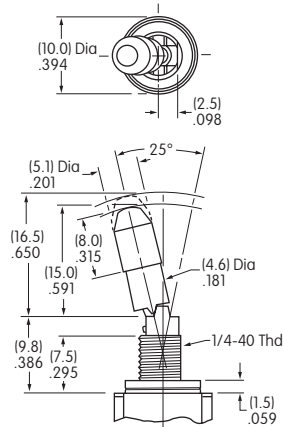

LL8 6mm/.295" (7.5mm)
Threaded Splashproof with D Flat

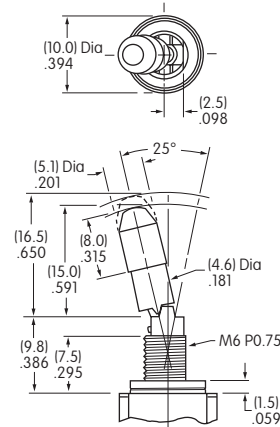

Maximum Panel Thickness with Standard Hardware: .047" (1.2mm)
Standard Hardware for L3 and L8: 1 hex nut AT513H or AT513M and 1 o-ring AT516

Lever Material & Finish: Brass with Chrome Plating

Locking Mechanism

on-none-on



2 positions lock

on-none-(on)



1 position locks

on-off-(on)
on-on-(on)



2 positions lock

on-off-on
on-on-on

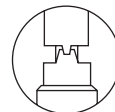

3 positions lock

(on)-off-(on)
(on)-on-(on)

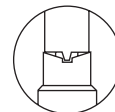

1 position locks

No Code

Supplied with Cap AT427

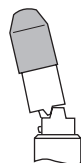

Lever

Color Codes for Optional Anodized Aluminum Caps

Cap Material:
Brass with Nickel Plating



Black



Red



Blue

CONTACT MATERIALS & RATINGS

W

Silver over Silver

Power Level

6A @ 125V AC & 3A @ 250V AC

G

Gold over Brass or Copper

Logic Level

0.4VA maximum @ 28V AC/DC maximum

Note: See Supplement section to find complete explanation of operating range.

A

Gold over Silver

Power Level
or Logic Level

6A @ 125V AC
or 0.4VA maximum @ 28V AC/DC maximum

Note: This dual rated option is suitable when two or more identical switches are used in logic and in power circuits within the same application. See Supplement section to find complete explanation of dual rating and operating range.

TERMINALS

01

Solder Lug

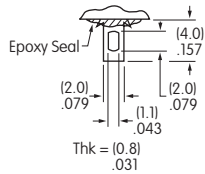

02

.062" (1.57mm) Wide Quick Connect

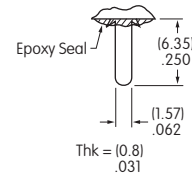

03

.250" (6.35mm) Straight PC

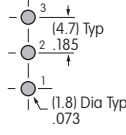
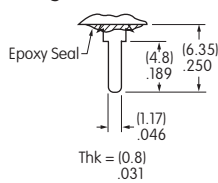

Single Pole

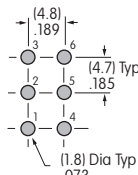

Double Pole

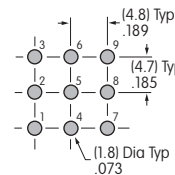

Three Pole

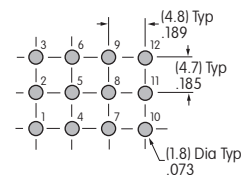

Four Pole

05

.425" (10.8mm) Wirewrap or Extended PC

07

.964" (24.5mm) Wirewrap or Extended PC

06

.750" (19.05mm) Wirewrap or Extended PC

08

1.062" (27.0mm) Wirewrap or Extended PC

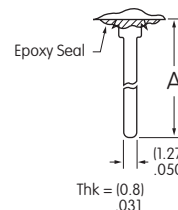

Dimension A = terminal lengths as shown beside the terminal codes at the left.

If using as extended PC terminal, refer to the above footprints.

OPTIONAL CAPS & CAP COLORS

B

* AT415 Lever Cap for S Bat Toggle

Material: Polyethylene

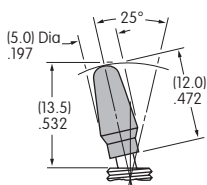

C

* AT444 Conical Cap for S Bat Toggle

Material: Polyethylene

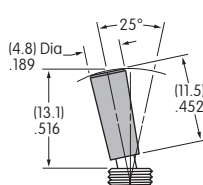

R

AT434 Lever Cap for B Toggle

Material: Polyvinyl Chloride

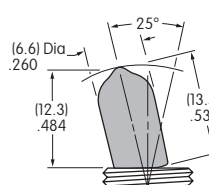

V

AT406 Lever Cap for B2 Toggle

Material: Polyvinyl Chloride

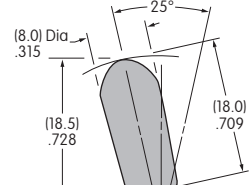

* AT415 and AT444 for use with S toggles only, not S2 or S3 toggles.

Cap Colors Available:

A

Black

B

White

C

Red

E

Yellow

F

Green

G

Blue

TYPICAL SWITCH DIMENSIONS

Solder Lug

Single Pole

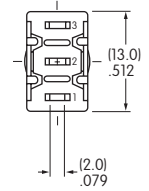
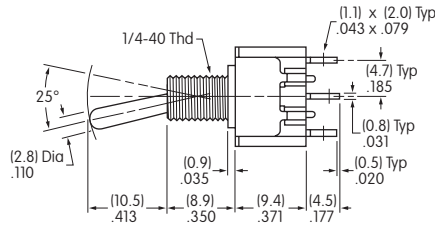
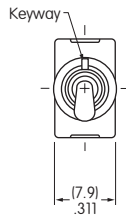

M2012SS1W01

M2011 model does not have terminal 1.

Solder Lug

Double Pole

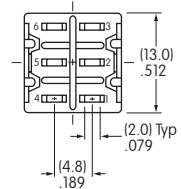
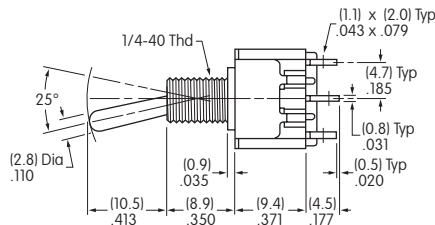
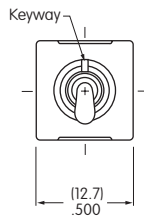

M2022SS1W01

M2021 model does not have terminals 1 & 4.

Solder Lug

Three Pole

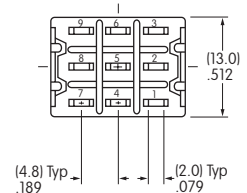
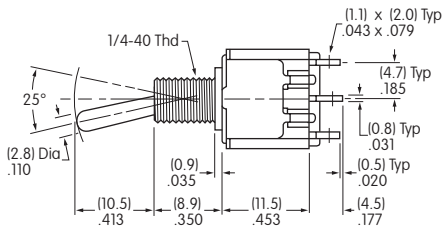
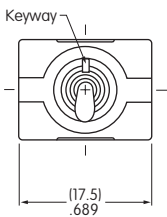

M2032SS1W01

Solder Lug

Four Pole

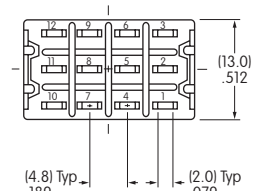
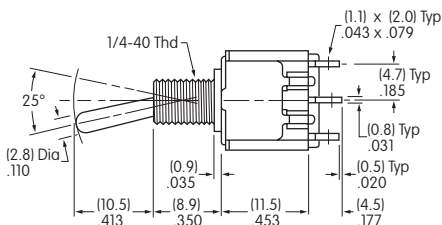
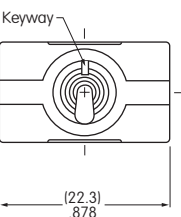

M2042SS1W01

Rockers

Pushbuttons

Illuminated PB

Programmable

Keylocks

Rotaries

Slides

Tactiles

Tilt

Touch

Indicators

Accessories

Supplement

STANDARD HARDWARE FOR SMALL & LARGE BUSHINGS

AT513H for Inch
AT513M for Metric
Hex Nut
Brass/Nickel

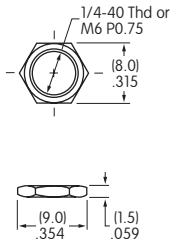

AT507H for Inch
AT507M for Metric
Locking Ring
Steel with Zinc/Chrome

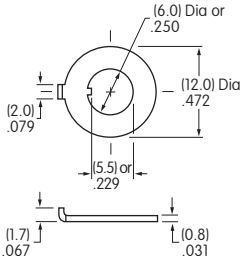

AT509
Lockwasher
Steel with Zinc/Chrome
(not supplied with splashproof models)

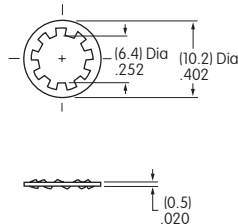

AT516
O-ring for Splashproof Models
Nitrile Butadiene Rubber

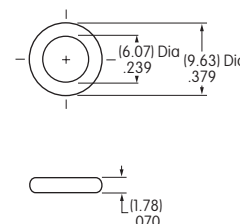

AT503M
Hex Face Nut
Brass/Chrome

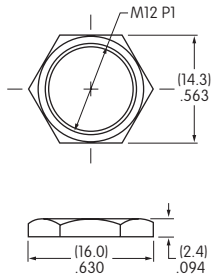

AT506M
Locking Ring
Steel with Zinc/Chrome

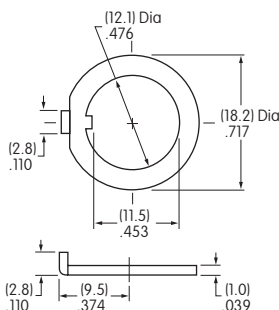

AT508
Lockwasher
Steel with Zinc/Chrome
(not supplied with splashproof models)

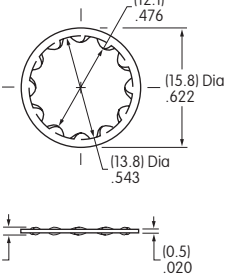

AT527M
Hex Nut
Steel with Nickel Plating

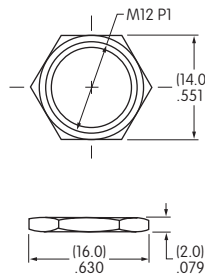

AT401P
O-ring for Splashproof Models
Nitrile butadiene rubber

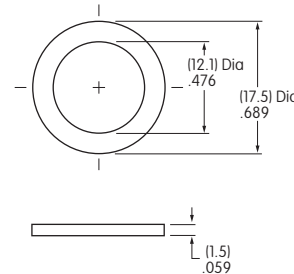

OPTIONAL SPLASHPROOF BOOTS

Various optional nuts and ON-OFF plates are available; dimensions are shown in the Accessories & Hardware section.

AT428 (M-metric H-Inch)
.445" (11.3mm)
Boot for S Toggle
Silicon Rubber

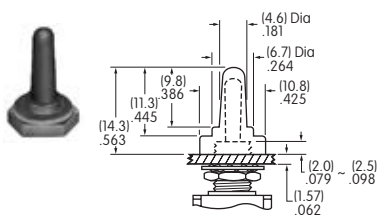

AT402
.760" (19.3mm)
Boot for B2 Toggle
Silicon Rubber

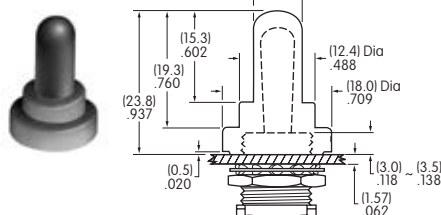

AT402S
.567" (14.4mm)
Boot for B Toggle
Silicon Rubber

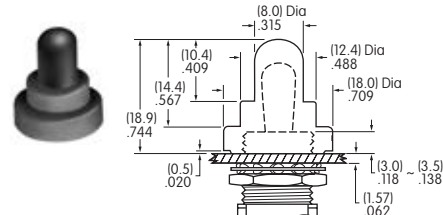

AT401A/H/S
.461" (11.7mm)
Boot, Nut and O-ring for B2 Toggle
More details in Accessories section

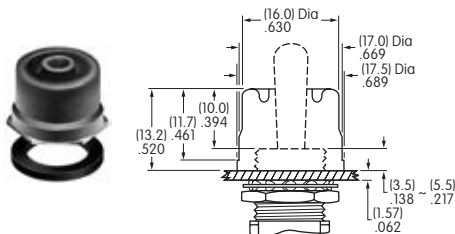

AT4181
.732" (18.6mm)
Boot, Nut and O-ring for B2 Toggle
More details in Accessories section

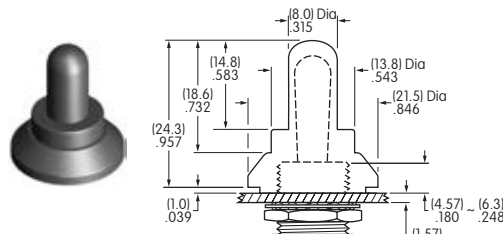

A Toggles
Rockers
Pushbuttons
Illuminated PB
Programmable
Keylocks
Rotaries
Slides
Tactiles
Tilt
Touch
Indicators
Accessories
Supplement

Toggles
A

Rockers

Pushbuttons

Illuminated PB

Programmable

Keylocks

Rotaries

Slides

Tactiles

Tilt

Touch

Indicators

Accessories

Supplement

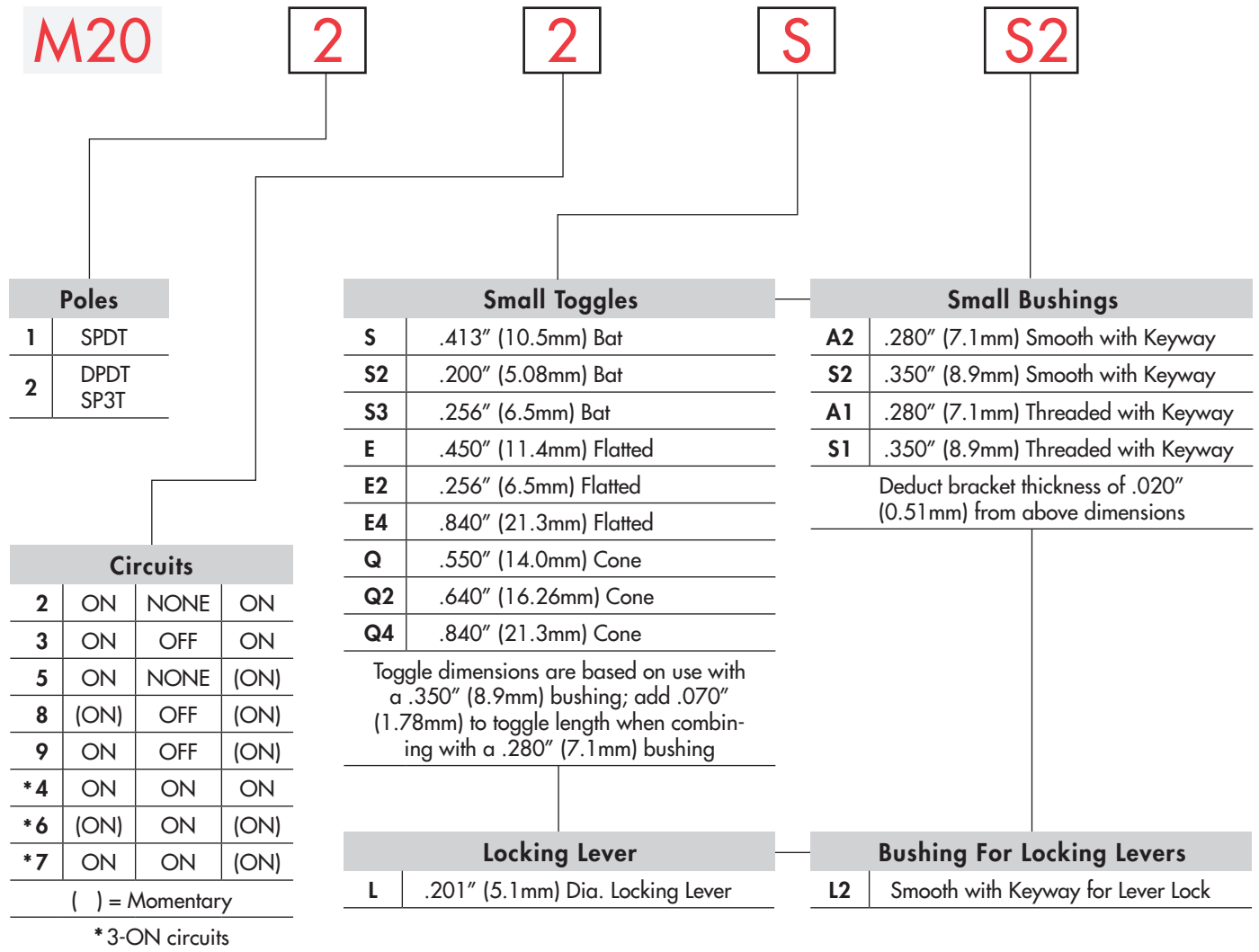

Standard Toggle & Bushing Combinations:

SS2 & S2A2

IMPORTANT:



Switches are supplied without UL, cULus & CSA marking unless specified.
UL, cULus & CSA recognized only when ordered with marking on the switch.
 Specific models, ratings & ordering instructions are noted on the General Specifications page.

ORDERING EXAMPLE

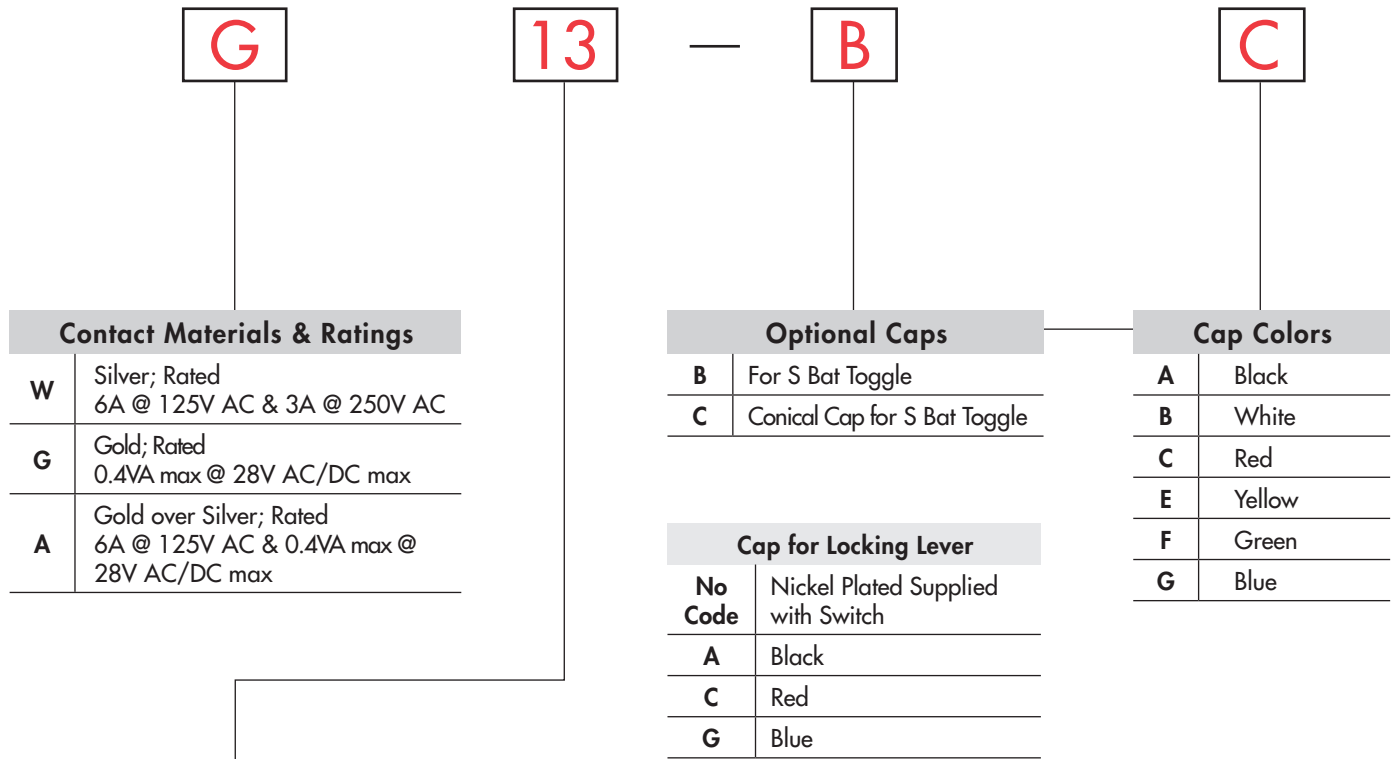

| Contact Materials & Ratings | |
|-----------------------------|--|
| W | Silver; Rated 6A @ 125V AC & 3A @ 250V AC |
| G | Gold; Rated 0.4VA max @ 28V AC/DC max |
| A | Gold over Silver; Rated 6A @ 125V AC & 0.4VA max @ 28V AC/DC max |

| Terminals | |
|-------------------------|--|
| With Bracket | |
| 13 | .250" (6.35mm) Straight PC with .465" (11.8mm) Bracket |
| 15 | .425" (10.8mm) Straight PC with .630" (16.0mm) Bracket |
| 17 | .964" (24.5mm) Straight PC with 1.150" (29.2mm) Bracket |
| With Reinforced Bracket | |
| 23 | .250" (6.35mm) Straight PC with .465" (11.8mm) Bracket |
| 25 | .425" (10.8mm) Straight PC with .630" (16.0mm) Bracket |
| 26 | .750" (19.05mm) Straight PC with .953" (24.2mm) Bracket |

| Optional Caps | |
|---------------|------------------------------|
| B | For S Bat Toggle |
| C | Conical Cap for S Bat Toggle |

| Cap for Locking Lever | |
|-----------------------|---------------------------------------|
| No Code | Nickel Plated Supplied with Switch |
| A | Black |
| C | Red |
| G | Blue |





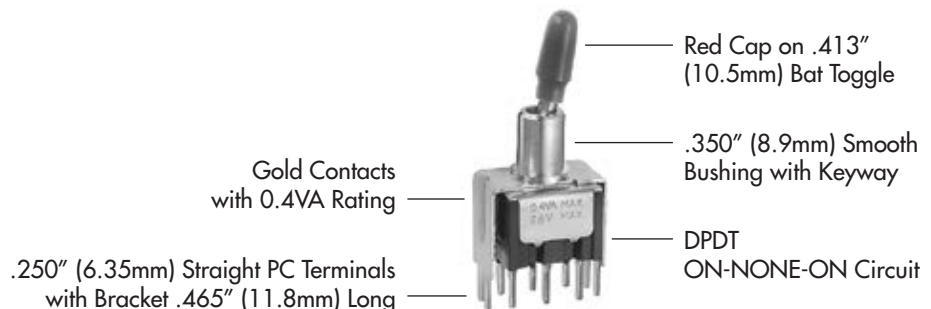

| Cap Colors | |
|------------|--------|
| A | Black |
| B | White |
| C | Red |
| E | Yellow |
| F | Green |
| G | Blue |

DESCRIPTION FOR TYPICAL ORDERING EXAMPLE

M2022SS2G13-BC

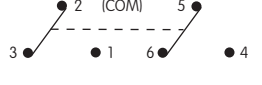

POLES & CIRCUITS

| Pole | Model | Toggle Position () = Momentary | | | Connected Terminals | | | Throw & Schematics |
|------|---|---|---|---|---|---|--|---|
| | | Down  | Center  | Up  | Down  | Center  | Up  | |
| SP | M2012 M2013 M2015 M2018 M2019 | ON ON ON (ON) ON | NONE OFF NONE OFF OFF | ON ON (ON) (ON) (ON) | 2-3 | OPEN | 2-1 | SPDT  |
| DP | M2022 M2023 M2025 M2028 M2029 | ON ON ON (ON) ON | NONE OFF NONE OFF OFF | ON ON (ON) (ON) (ON) | 2-3 5-6 | OPEN | 2-1 5-4 | DPDT  |

For 3 Throw (3-On)

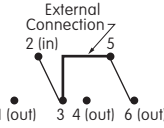
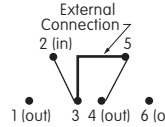
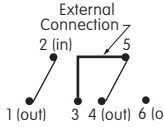
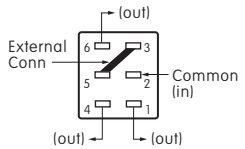
| Pole | Model | Connected Terminals & Schematics | | | External Connection |
|------|-------------------------|--|--|---|--|
| | | Down | Center | Up | |
| SP | M2024 M2026 M2027 | ON (ON) ON  | ON ON ON  | ON (ON) (ON)  | The SP3T model utilizes a double pole base. External connection must be made during field installation.  |

SMALL TOGGLES

Important:

Toggle length changes based on bushing selected. All illustrations are shown with .350" (8.9mm) long bushing. When using a .280" (7.1mm) long bushing, toggle length increases .070" (1.78mm).

Standard Material & Finish:

Brass with Bright Chrome
Contact factory for optional finishes.

S .413" (10.5mm) Bat

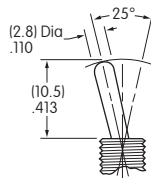

S2 .200" (5.08mm) Bat

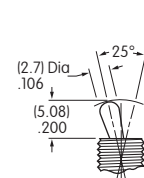

S3 .256" (6.5mm) Bat

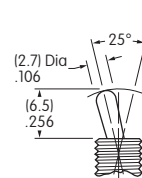

E .450" (11.4mm) Flatted

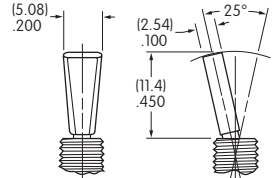

E2 .256" (6.5mm) Flatted

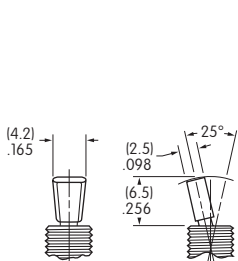

E4 .840" (21.3mm) Flatted

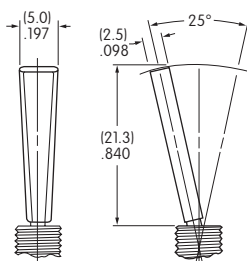

Q .550" (14.0mm) Cone

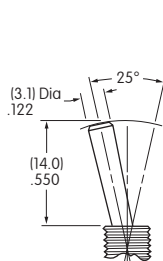

Q2 .640" (16.26mm) Cone

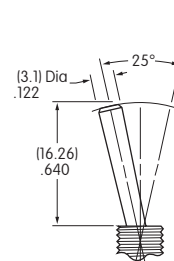

Q4 .840" (21.3mm) Cone

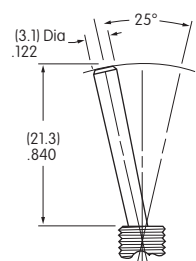

SMALL BUSHINGS

A Toggles

A2 .280" (7.1mm)
Smooth with Keyway

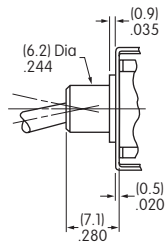
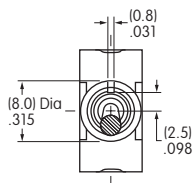

S2 .350" (8.9mm)
Smooth with Keyway

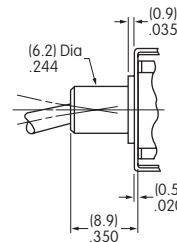
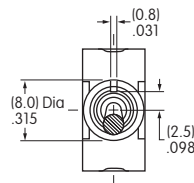

When using this bushing, toggle length is increased by .070" (1.78mm).

A1 .280" (7.1mm)
Threaded with Keyway

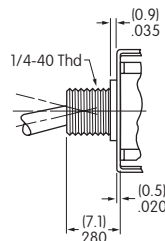
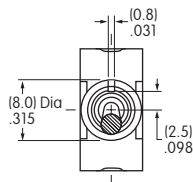

S1 .350" (8.9mm)
Threaded with Keyway

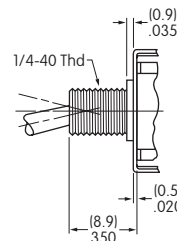
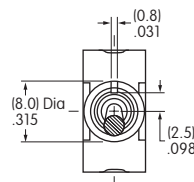

When using this bushing, toggle length is increased by .070" (1.78mm). Maximum Panel Thickness with Standard Hardware: .031" (0.8mm)

Maximum Panel Thickness with Standard Hardware: .102" (2.6mm)

Panel Cutouts

For A2, S2, A1, or S1 Bushing with Keyway

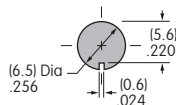

For A1 or S1 Bushing with Locking Ring

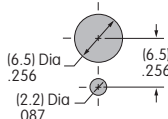

Standard Hardware:
2 Hex Nuts (AT513H)
1 Lockwasher (AT509)
1 Locking Ring (AT507H)
For dimensions, see Accessories & Hardware section.

Rockers

Pushbuttons

Illuminated PB

Programmable

Keylocks

Rotaries

Slides

Tactiles

Tilt

Touch

Indicators

Accessories

Supplement

LOCKING LEVER & BUSHING

LL2 Smooth with Keyway

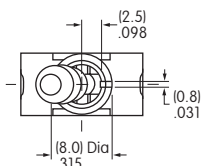

Locking Mechanism

on-none-on

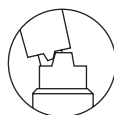

2 positions lock

on-none-(on)



1 position locks

on-off-(on)
on-on-(on)



2 positions lock

on-off-on
on-on-on

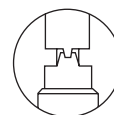

3 positions lock

(on)-off-(on)
(on)-on-(on)

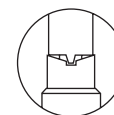

1 position locks

No Code

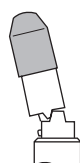

Cap for Locking Lever
Supplied with Cap AT427
Material & Finish:
Brass with Nickel Plating
Lever Material & Finish:
Brass with Chrome Plating

Color Codes for Optional Anodized Aluminum Caps

A Black

C Red

G Blue

CONTACT MATERIALS & RATINGS

W Silver over Silver Power Level 6A @ 125V AC & 3A @ 250V AC

G Gold over Brass or Copper Logic Level 0.4VA maximum @ 28V AC/DC maximum

Note: See Supplement section to find complete explanation of operating range.

A Gold over Silver Power Level or Logic Level 6A @ 125V AC or 0.4VA maximum @ 28V AC/DC maximum

Note: This dual rated option is suitable when two or more identical switches are used in logic and in power circuits within the same application. See Supplement section to find complete explanation of dual rating and operating range.

TERMINALS

Straight PC Mount with Bracket

Straight PC Mount with Reinforced Bracket

| 13 | 15 | 17 | 23 | 25 | 26 |
|--|--|---|--|--|---|
| .250" (6.35mm) Terminal with .465" (11.8mm) Bracket | .425" (10.8mm) Terminal with .630" (16.0mm) Bracket | .964" (24.5mm) Terminal with 1.150" (29.2mm) Bracket | .250" (6.35mm) Terminal with .465" (11.8mm) Bracket | .425" (10.8mm) Terminal with .630" (16.0mm) Bracket | .750" (19.05mm) Terminal with .953" (24.2mm) Bracket |

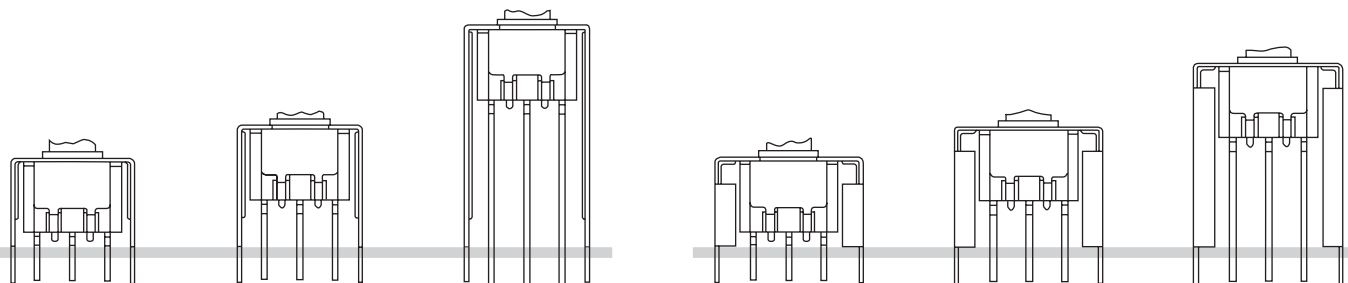

PCB footprints are on the following Typical Switch Dimension page.

OPTIONAL CAPS & CAP COLORS

B * AT415
for S Bat Toggle

Material:
Polyethylene

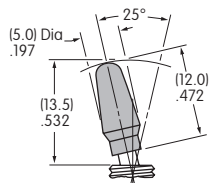

C * AT444
Conical Cap for
S Bat Toggle

Material:
Polyethylene

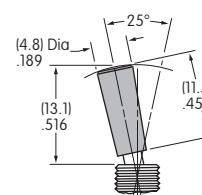

* AT415 and AT444 for use with S toggles only, not S2 or S3 toggles.

Cap Colors
Available:

A Black **B** White **C** Red **E** Yellow **F** Green **G** Blue

Toggles A
Rockers
Pushbuttons
Illuminated PB
Programmable
Keylocks
Rotaries
Slides
Tactiles
Tilt
Touch
Indicators
Accessories
Supplement

TYPICAL SWITCH DIMENSIONS

Straight PC • Bracket

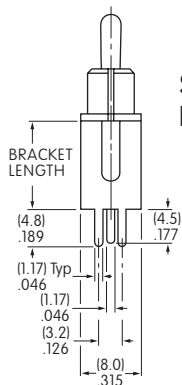

Single Pole

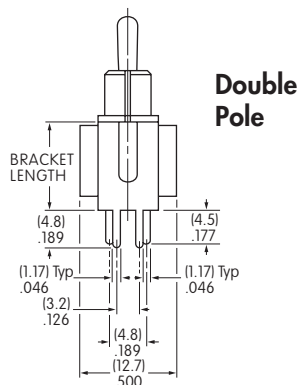

Double Pole

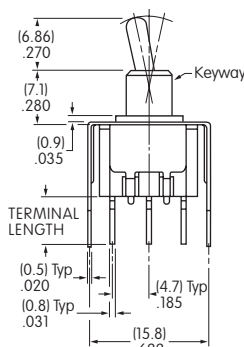

M2012S2A2G13

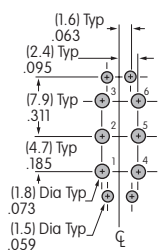
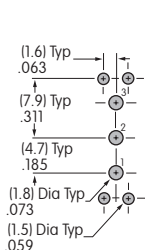

| Terminal Code: | Terminal Length: | Bracket Length: |
|----------------|------------------|-----------------|
| 13 | .250" (6.35mm) | .465" (11.8mm) |
| 15 | .425" (10.8mm) | .630" (16.0mm) |
| 17 | .964" (24.5mm) | 1.150" (29.2mm) |

Straight PC • Reinforced Bracket

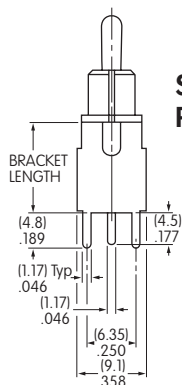

Single Pole

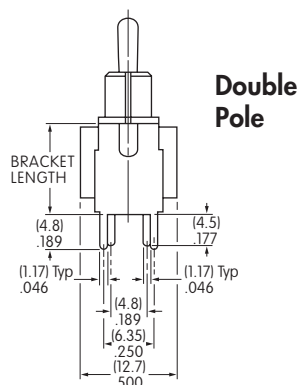

Double Pole

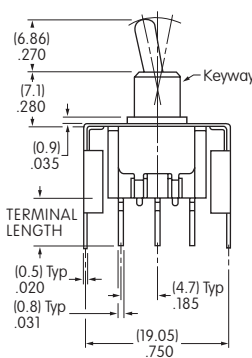

M2012S2A2G23

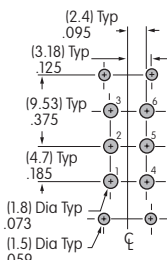
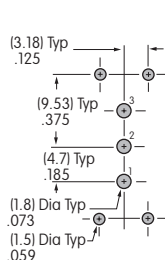

| Terminal Code: | Terminal Length: | Bracket Length: |
|----------------|------------------|-----------------|
| 23 | .250" (6.35mm) | .465" (11.8mm) |
| 25 | .425" (10.8mm) | .630" (16.0mm) |
| 26 | .750" (19.05mm) | .953" (24.2mm) |

M20

1

2

S2

A2

Poles

| | |
|-----------|--------------|
| 1 | SPDT |
| 2 | DPDT SP3T |
| 3 | 3PDT |
| *4 | 4PDT DP3T |

*4-pole available on vertical models only.

Circuits

| | | | |
|-----------|------|------|------|
| 2 | ON | NONE | ON |
| 3 | ON | OFF | ON |
| 5 | ON | NONE | (ON) |
| 8 | (ON) | OFF | (ON) |
| 9 | ON | OFF | (ON) |
| *4 | ON | ON | ON |
| *6 | (ON) | ON | (ON) |
| *7 | ON | ON | (ON) |

() = Momentary

* 3-ON circuits available with double and four pole bases only

Small Toggles

| | |
|-----------|------------------------|
| S | .413" (10.5mm) Bat |
| S2 | .200" (5.08mm) Bat |
| S3 | .256" (6.5mm) Bat |
| E | .450" (11.4mm) Flatted |
| E2 | .256" (6.5mm) Flatted |

Toggle dimensions are based on use with a .350" (8.9mm) bushing; add .070" (1.78mm) to toggle length when combining with a .280" (7.1mm) bushing.

Locking Lever

| | |
|----------|----------------------------------|
| L | .201" (5.1mm) Dia. Locking Lever |
|----------|----------------------------------|

Small Bushings

| | |
|-----------|------------------------------------|
| A2 | .280" (7.1mm) Smooth with Keyway |
| S2 | .350" (8.9mm) Smooth with Keyway |
| A1 | .280" (7.1mm) Threaded with Keyway |
| S1 | .350" (8.9mm) Threaded with Keyway |

Bushing For Locking Levers

| | |
|-----------|-----------------------------------|
| L2 | Smooth with Keyway for Lever Lock |
|-----------|-----------------------------------|

Standard Toggle, Bushing, & Terminal Combinations:

S2A2G30, S2A2G40, SS2G30, SS2G40, LL2G30, & LL2G40

IMPORTANT:



Switches are supplied without UL, cULus & CSA marking unless specified. **UL, cULus & CSA recognized only when ordered with marking on the switch.** Specific models, ratings & ordering instructions are noted on the General Specifications page.

ORDERING EXAMPLE

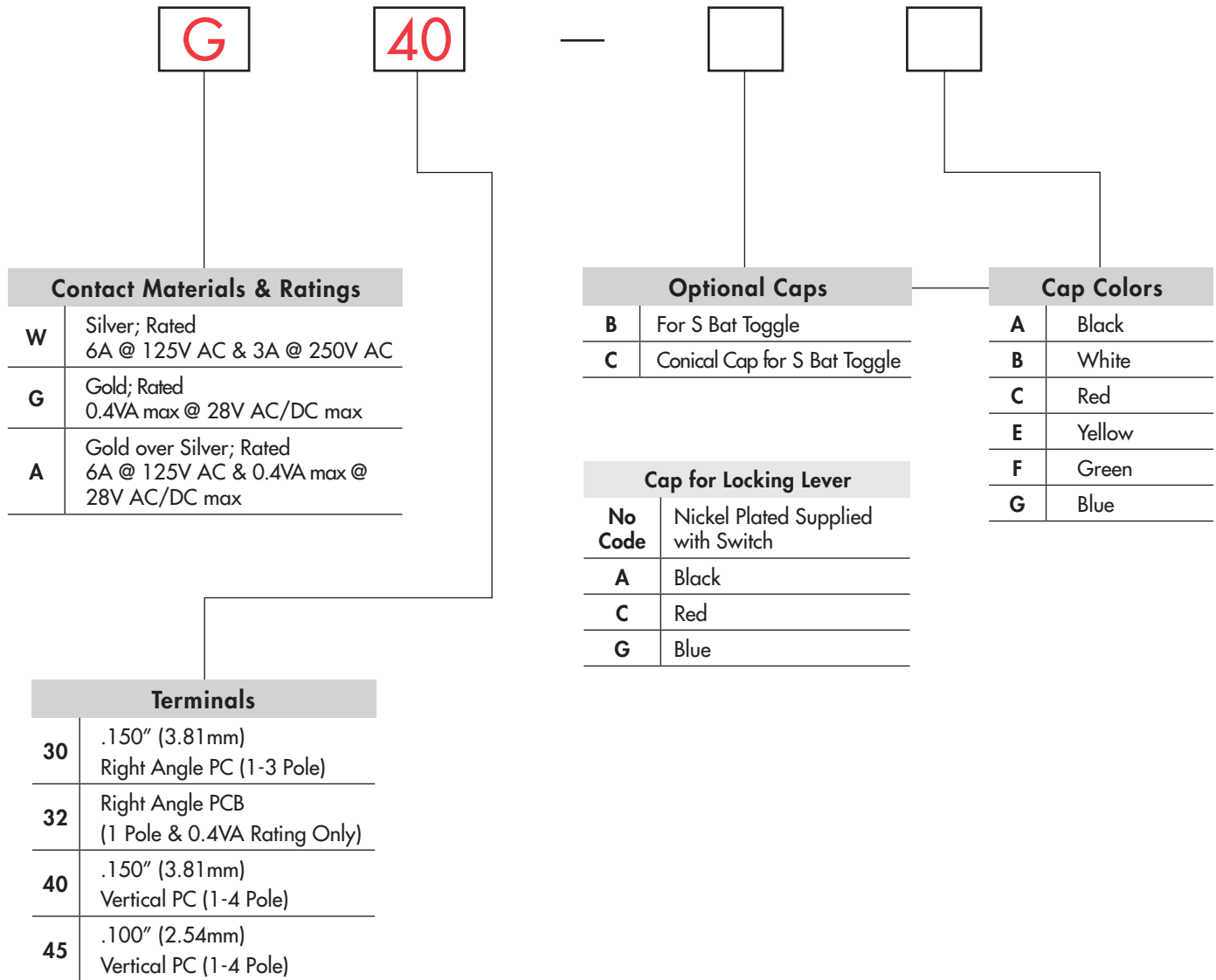





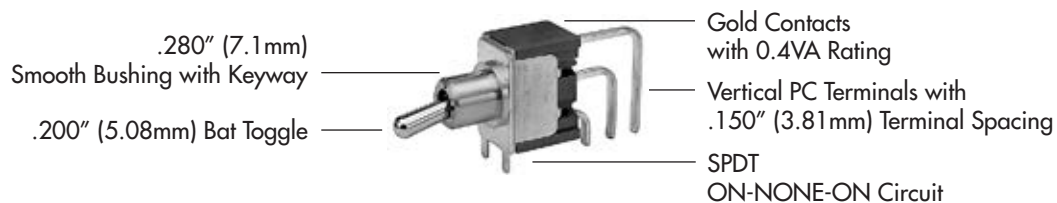

DESCRIPTION FOR TYPICAL ORDERING EXAMPLE

M2012S2A2G40

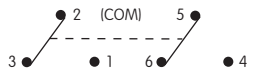
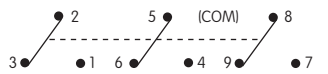
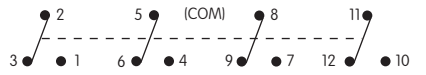

POLES & CIRCUITS

| Pole | Model | Toggle Position () = Momentary | | | Connected Terminals | | | Throw & Schematics |
|------|---|---|---|---|---|---|---|--|
| | | Down  | Center  | Up  | Down  | Center  | Up  | |
| SP | *M2012 *M2013 *M2015 *M2018 M2019 | ON ON ON (ON) ON | NONE OFF NONE OFF OFF | ON ON (ON) (ON) (ON) | 2-3 | OPEN | 2-1 | Note: Terminal numbers are not actually on the switch. * Reverse circuits available for vertical mount SP & DP upon request.  |
| DP | *M2022 *M2023 *M2025 *M2028 M2029 | ON ON ON (ON) ON | NONE OFF NONE OFF OFF | ON ON (ON) (ON) (ON) | 2-3 5-6 | OPEN | 2-1 5-4 |  |
| 3P | M2032 M2033 M2035 M2038 M2039 | ON ON ON (ON) ON | NONE OFF NONE OFF OFF | ON ON (ON) (ON) (ON) | 2-3 5-6 8-9 | OPEN | 2-1 5-4 8-7 |  |
| 4P | M2042 M2043 M2045 M2048 M2049 | ON ON ON (ON) ON | NONE OFF NONE OFF OFF | ON ON (ON) (ON) (ON) | 2-3 5-6 8-9 11-12 | OPEN | 2-1 5-4 8-7 11-10 |  |

For 3 Throw (3-On)

Connected Terminals & Schematics

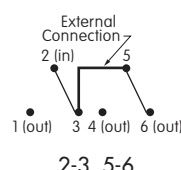
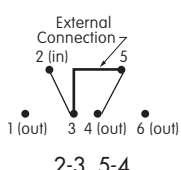
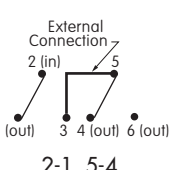
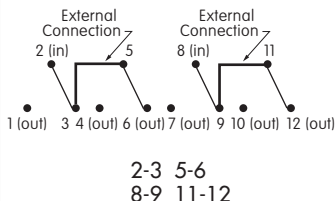
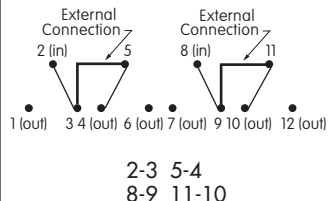
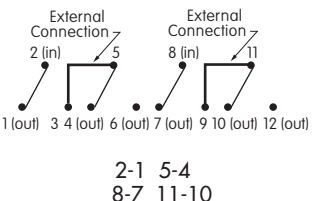
| Pole | Model | Down | Center | Up | Down | Center | Up |
|------|-------------------------|------------------|----------------|--------------------|---|--|---|
| SP | M2024 M2026 M2027 | ON (ON) ON | ON ON ON | ON (ON) (ON) |  |  |  |
| DP | M2044 M2046 M2047 | ON (ON) ON | ON ON ON | ON (ON) (ON) |  |  |  |

The SP3T model utilizes a double pole base.

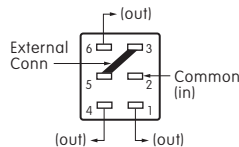

External connection must be made during field installation.

The DP3T model utilizes a four pole base.

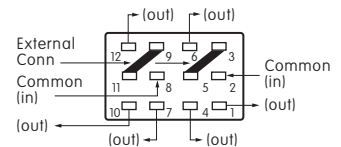

External connection must be made during field installation.

SMALL TOGGLES

Important:

Toggle length changes based on bushing selected. All illustrations are shown with .350" (8.9mm) long bushing. When using a .280" (7.1mm) long bushing, toggle length increases .070" (1.78mm).

S .413" (10.5mm)
Bat

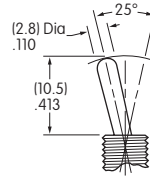

S2 .200" (5.08mm)
Bat

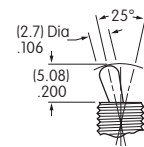

S3 .256" (6.5mm)
Bat

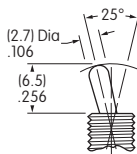

E .450" (11.4mm)
Flatted

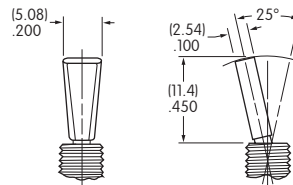

E2 .256" (6.5mm)
Flatted

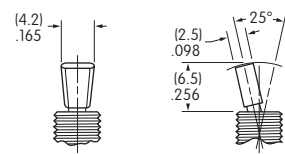

Standard Material & Finish: Brass with Bright Chrome
Contact factory for optional finishes.

SMALL BUSHINGS

A2 .280" (7.1mm)
Smooth with Keyway

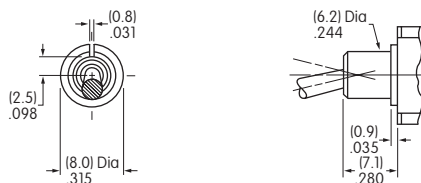

S2 .350" (8.9mm)
Smooth with Keyway

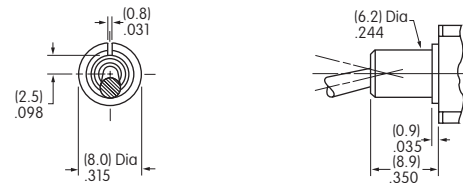

When using this bushing, toggle length is increased by .070" (1.78mm).

A1 .280" (7.1mm)
Threaded with Keyway

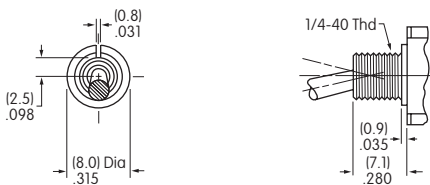

S1 .350" (8.9mm)
Threaded with Keyway

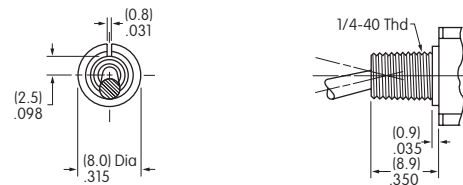

When using this bushing, toggle length is increased by .070" (1.78mm). Maximum Panel Thickness with Standard Hardware: .031" (0.8mm)

Maximum Panel Thickness with Standard Hardware: .102" (2.6mm)

Panel Cutouts

For A2, S2, A1 or S1 Bushing with Keyway

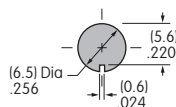

For A1 or S1 Bushing with Locking Ring

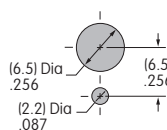

Standard Hardware:

- 2 Hex Nuts (AT513H)
- 1 Lockwasher (AT509)
- 1 Locking Ring (AT507H)

For dimensions, see Accessories & Hardware section.

LOCKING LEVER & BUSHING

LL2 Smooth with Keyway

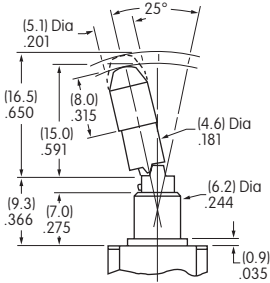
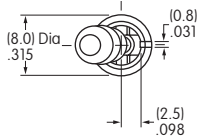

2 positions lock



1 position locks



2 positions lock

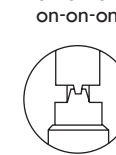

3 positions lock

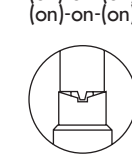

1 position locks

Locking Mechanism

No Code

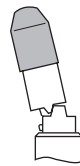

Cap for Locking Lever
Supplied with Cap AT427
Material & Finish:
 Brass with Nickel Plating
Lever Material & Finish:
 Brass with Chrome Plating

Color Codes for Optional Anodized Aluminum Caps

| | | | |
|----------|-------|----------|-----|
| A | Black | C | Red |
| G | Blue | | |

CONTACT MATERIALS & RATINGS

W Silver over Silver **Power Level** 6A @ 125V AC & 3A @ 250V AC

G Gold over Brass or Copper **Logic Level** 0.4VA maximum @ 28V AC/DC maximum

Note: See Supplement section to find complete explanation of operating range.

A Gold over Silver **Power Level or Logic Level** 6A @ 125V AC or 0.4VA maximum @ 28V AC/DC maximum

Note: This dual rated option is suitable when two or more identical switches are used in logic and in power circuits within the same application. See Supplement section to find complete explanation of dual rating and operating range.

TERMINALS

30 .150" (3.81 mm) Right Angle PC (1-3 Pole)

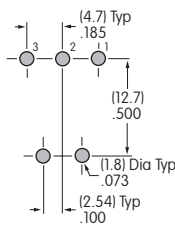
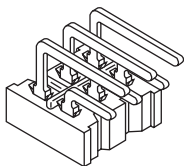

Single Pole

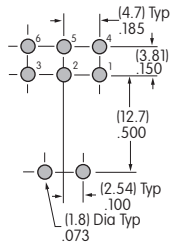

Double Pole

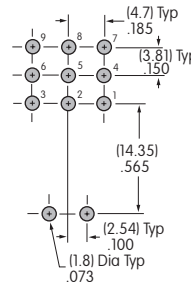

Three Pole

32 Right Angle PCB with Reverse Circuit (1 Pole & 0.4VA Rating Only)

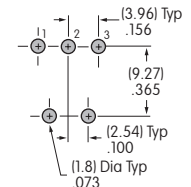
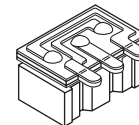

Terminal dimensions are shown on the Typical Switch Dimensions pages which follow.

TERMINALS (Continued)

A
Toggles

40 .150" (3.81mm)
Vertical PC (1-4 Pole)

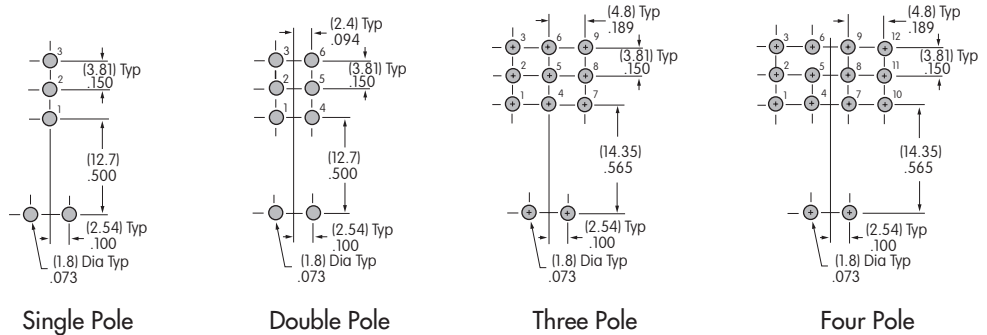
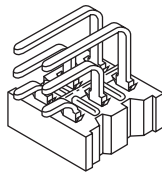

Rockers

Pushbuttons

Illuminated PB

45 .100" (2.54mm)
Vertical PC (1-4 Pole)

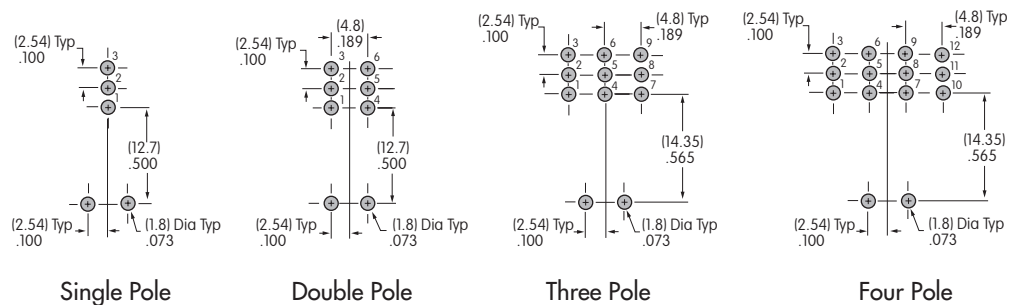
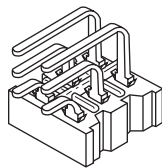

Programmable

Keylocks

Rotaries

Terminal dimensions are shown on the Typical Switch Dimensions pages which follow.

OPTIONAL CAPS & CAP COLORS

B * AT415
for S Bat Toggle

Material:
Polyethylene

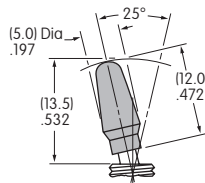

C * AT444
Conical Cap for S Bat Toggle

Material:
Polyethylene

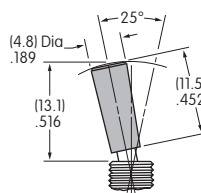

Colors Available

- | | |
|----------------|-----------------|
| A Black | E Yellow |
| B White | F Green |
| C Red | G Blue |

* AT415 and AT444 for use with S toggles only, not S2 or S3 toggles.

Slides

Tactiles

Tilt

STANDARD HARDWARE

AT513H for Inch
AT513M for Metric
Hex Nut (2 per switch)
Brass/Nickel

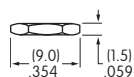
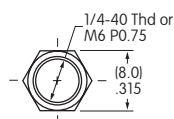

AT507H for Inch
AT507M for Metric
Locking Ring (1 per switch)
Steel with Zinc/Chromate

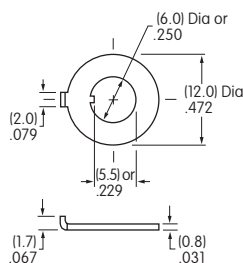

AT509
Lockwasher (1 per switch, none with splashproof)
Steel with Zinc/Chromate

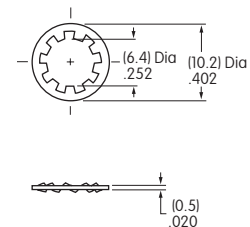

Touch

Indicators

Accessories

Supplement

TYPICAL SWITCH DIMENSIONS

.150" (3.81mm) Right Angle PC

Single Pole

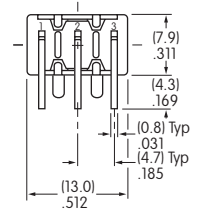
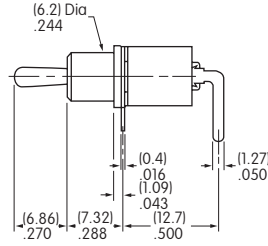
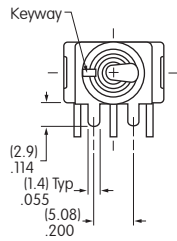

M2012S2A2G30

.150" (3.81mm) Right Angle PC

Double Pole

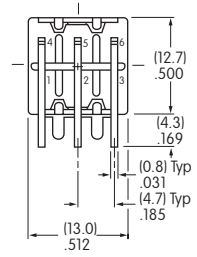
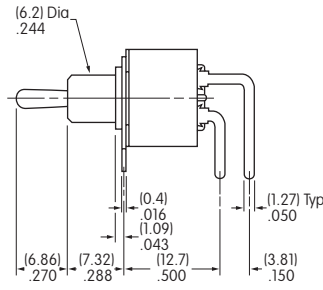
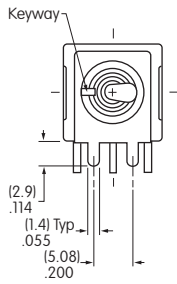

M2022S2A2G30

.150" (3.81mm) Right Angle PC

Three Pole

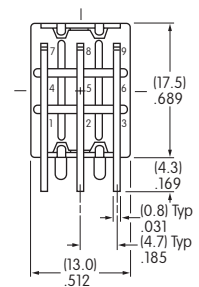
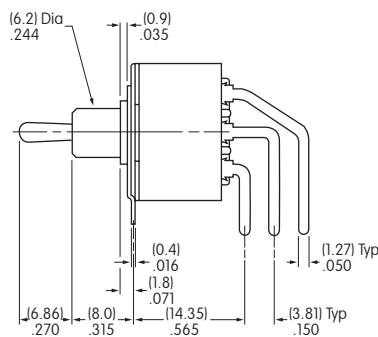
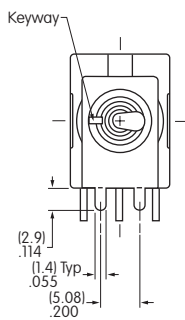

M2032S2A2G30

Rockers

Pushbuttons

Illuminated PB

Programmable

Keylocks

Rotaries

Slides

Tactiles

Tilt

Touch

Indicators

Accessories

Supplement

TYPICAL SWITCH DIMENSIONS

Single Pole • Reverse Circuit

Right Angle PCB

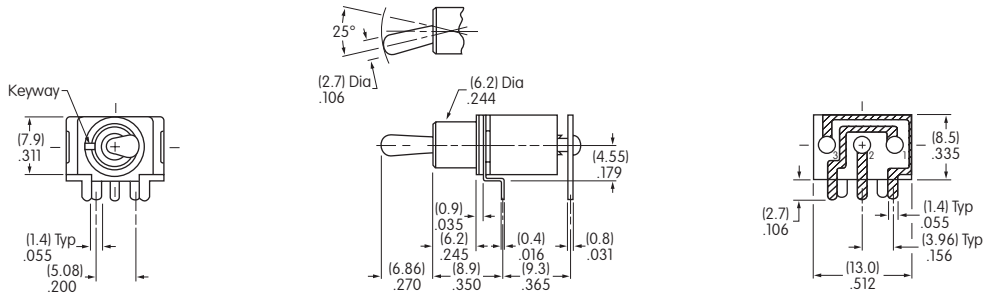

M2012S2A2G32

Single Pole

.150" (3.81mm) Vertical PC

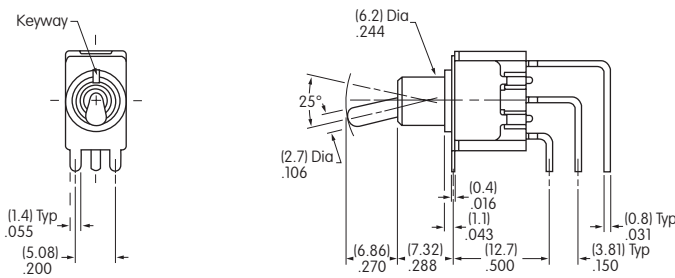

M2012S2A2G40

Double Pole

.150" (3.81mm) Vertical PC

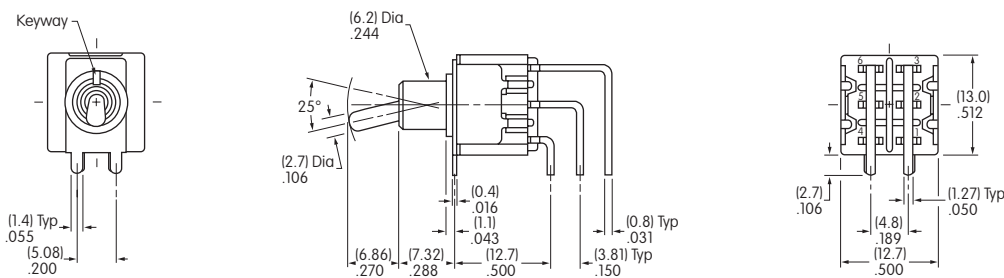

M2022S2A2G40

TYPICAL SWITCH DIMENSIONS

.150" (3.81mm) Vertical PC

Three Pole

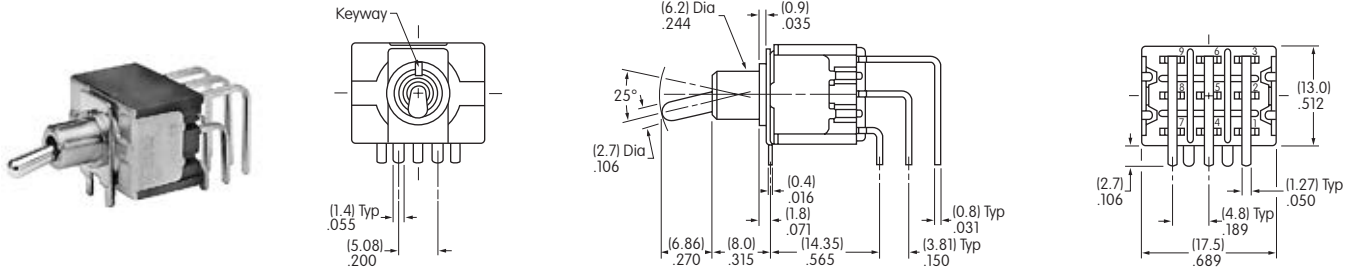

M2032S2A2G40

.150" (3.81mm) Vertical PC

Four Pole

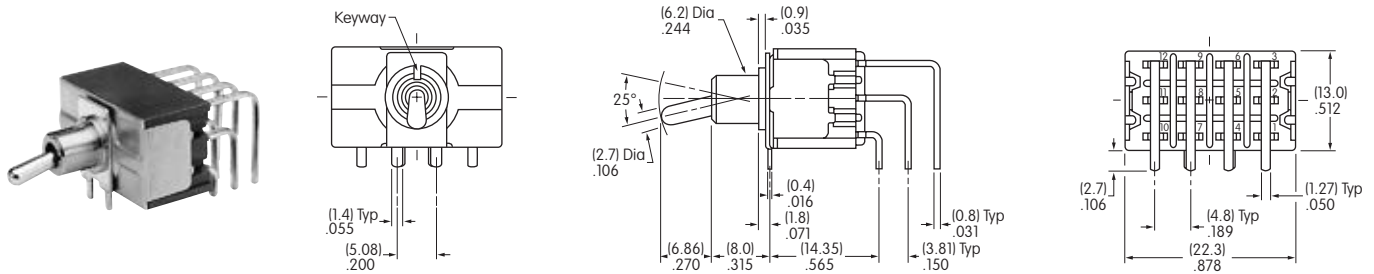

M2042S2A2G40

.100" (2.54mm) Vertical PC

Single Pole

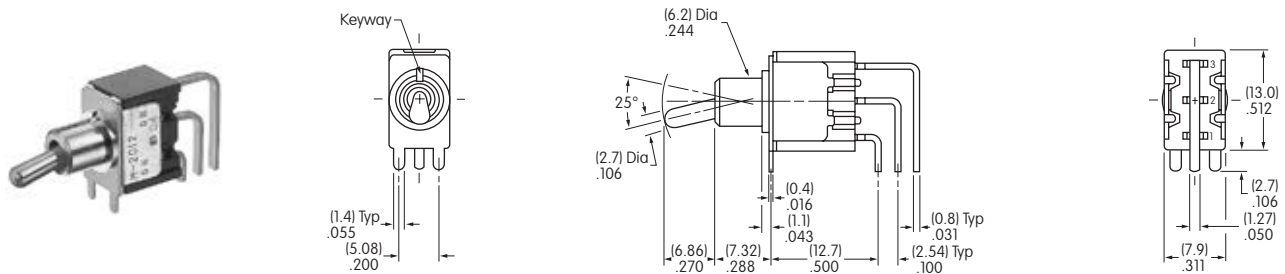

M2012S2A2G45

TYPICAL SWITCH DIMENSIONS

Double Pole

.100" (2.54mm) Vertical PC

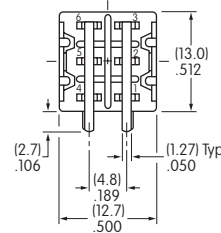
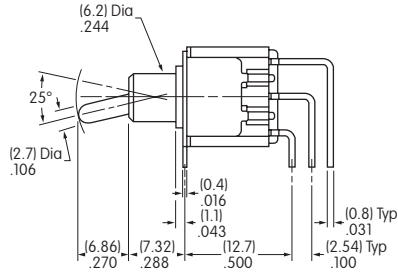
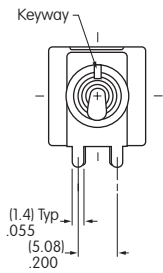

M2022S2A2G45

Three Pole

.100" (2.54mm) Vertical PC

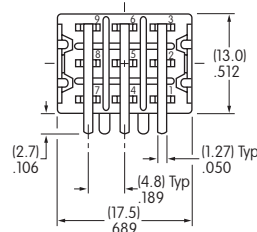
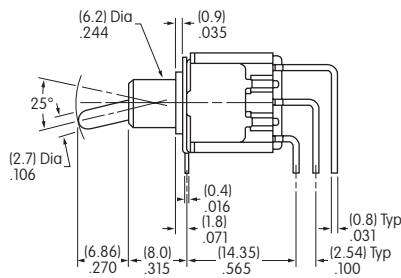
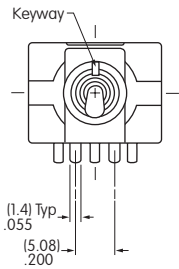

M2032S2A2G45

Four Pole

.100" (2.54mm) Vertical PC

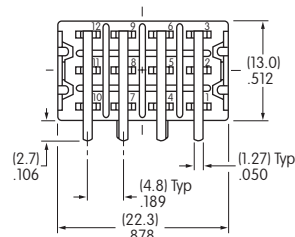
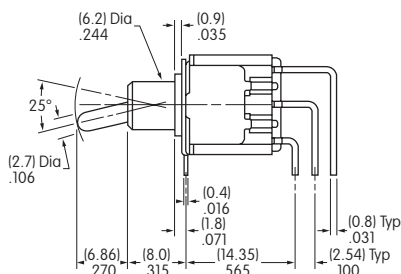
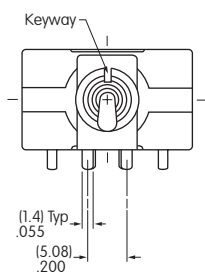

M2042S2A2G45

Mouser Electronics

Authorized Distributor

Click to View Pricing, Inventory, Delivery & Lifecycle Information:

NKK Switches:

[M2113LFW03](#) [M2112LCFG01](#) [M2112LFW03](#) [M2035E2A1W01](#) [M2044SD3W03](#) [M2024B2B1W01](#)
[M2022B2B1W05](#) [M2123LFG01](#) [M2123TFG02](#) [M2013Q2S1W01](#) [M2042S2S1W01](#) [M2023S2S2G03](#)
[M2022Q2S1W01](#) [M2023Q2S1W01](#) [M2113TCFG02](#) [M2123TCFW02](#) [M2112LCFW03](#) [M2123LCFG01](#)
[M2027SS1W01-RO](#) [M2113LFW02](#) [M2112JCFG01-A](#) [M2113REG02](#) [M2112JCFW01-G](#) [M2012E4S1W01/5-RO](#)
[M2012K2S1W01-H-RO](#) [M2023E4S1W01-RO](#) [M2026SS1G01/316](#) [M2044B2B1W01-RO](#) [M2018SS4W01-CA-RO](#)
[M2012ES1G06-RO](#) [M2018S3S1A01-RO](#) [M2019SS1W01-BA](#) [M2021SS1W03-CG-RO](#) [M2015L1L3W01-RO](#)
[M2024LL1W01-H](#) [M2032LL1W01-RO](#) [M2022E4S1G01-RO](#) [M2047SS1W01-BC](#) [M2027SS1W01-BC](#) [M2024BB1W02](#)
[M2011SS4W03](#) [M2022SS4W03](#) [M2015ES1A01](#) [M2023ED1W01](#) [M2013S2S1W03-RO](#) [M2033LL1W03-RO](#)
[M2022E4S1W01-RO](#) [M2112LCFW01-RO](#) [M2112TCFG01](#) [M2113TCG03](#) [M2011LL1W01-RO](#) [M2012LL1W03-RO](#)
[M2012S2S1W03-RO](#) [M2018B2B1W01-RO](#) [M2018EA1G01-RO](#) [M2022LL1G03-RO](#) [M2113TEFW01-RO](#)
[M2022EA1G01](#) [M2026K2S1W01-H-RO](#) [M2013LL1G30-RO](#) [M2025SS1W03-CG-RO](#) [M2015SA1G01-RO](#)
[M2011B2B1W02](#) [M2012ES1W01/AT532TH-RO](#) [M2039SS1G01](#) [M2019LL1G01-A](#) [M Series Kit](#) [M2022SD1W01](#)
[M2023E4S1W01](#) [M2021SS1W03-CG](#) [M2012LL4A01](#) [M2032B2B1W03](#) [M2013SS1G30-BB](#) [M2044B2B1A01](#)
[M2012SS4W03](#) [M2013E2S1W03](#) [M2018B2B3W03](#) [M2018BB1G01](#) [M2022SS4W01](#) [M2043SS4W03](#) [M2012BB3W03](#)
[M2013S3A2W45](#)