

THIS DRAWING IS UNPUBLISHED. RELEASED FOR PUBLICATION
 © COPYRIGHT - By - ALL RIGHTS RESERVED.

LOC	DIST	REVISIONS					
FT	0	P	LTR	DESCRIPTION	DATE	DWN	APVD
			B4	REVISED PER ECO-11-004820	11MAR11	RK	HMR

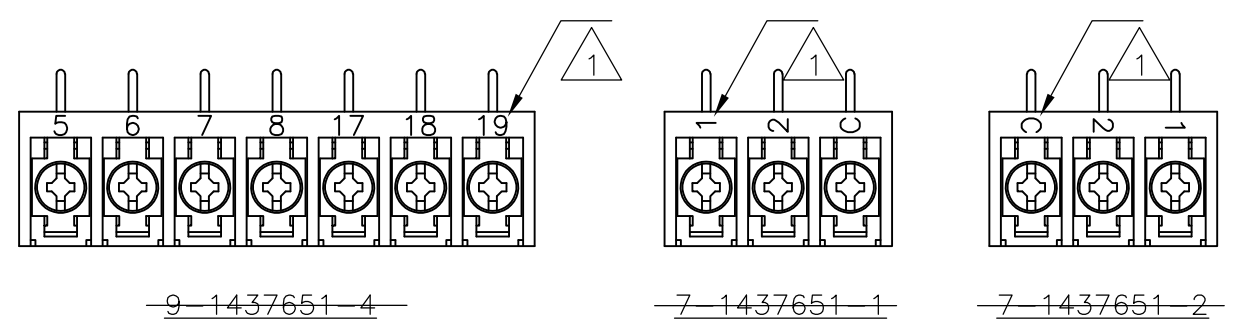
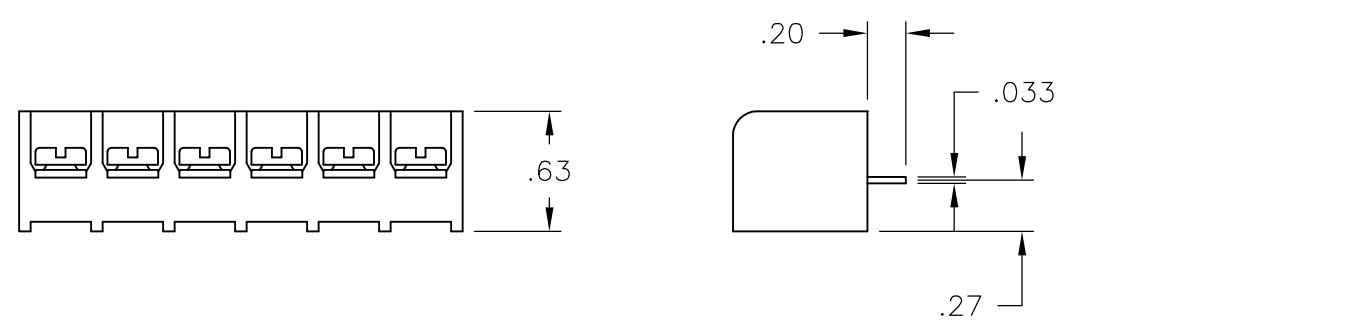
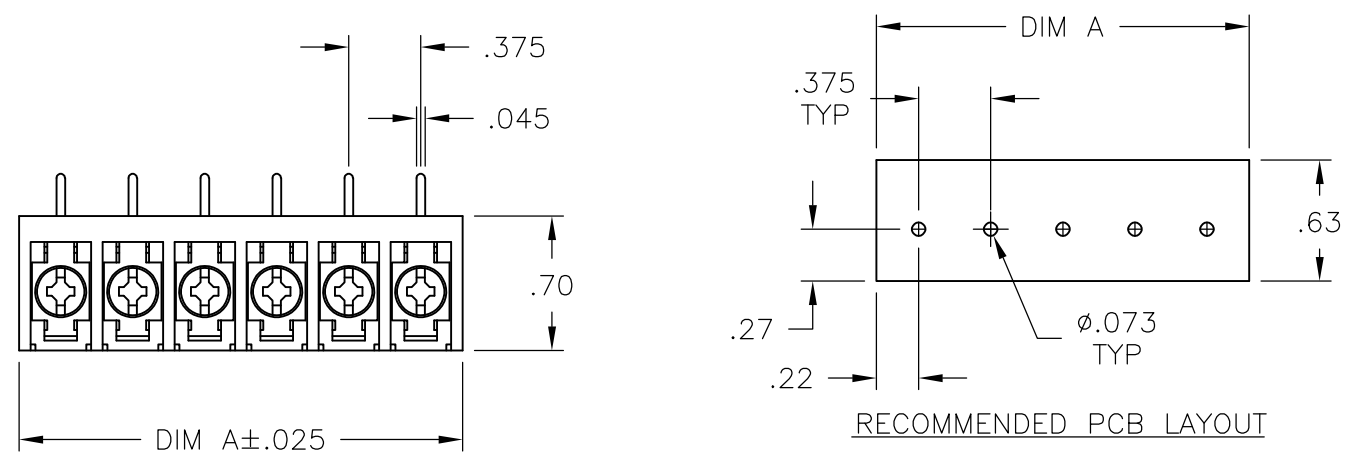

11.311	30	6PCR-30-006	1546817-2
10.936	29	6PCR-29-006	1546817-1
10.561	28	6PCR-28-006	1-1546399-3
10.186	27	6PCR-27-006	1-1546399-2
9.811	26	6PCR-26-006	1-1546399-1
9.436	25	6PCR-25-006	1-1546399-0
9.061	24	6PCR-24-006	1546399-1
8.686	23	6PCR-23-006	1546399-9
8.311	22	6PCR-22-006	1546399-8
7.936	21	6PCR-21-006	1546399-7
7.561	20	6PCR-20-006	796988-4
7.186	19	6PCR-19-006	1546399-6
6.811	18	6PCR-18-006	4-1546158-0
6.436	17	6PCR-17-006	1546399-5
6.061	16	6PCR-16-006	1546399-4
5.686	15	6PCR-15-006	1546399-3
5.311	14	6PCR-14-006	3-1546158-9
4.936	13	6PCR-13-006	1546399-2
4.561	12	6PCR-12-006	1-1437652-3
4.186	11	6PCR-11-006	1-1437652-1
3.811	10	6PCR-10-006	1437652-8
3.436	9	6PCR-09-006	1437652-5
3.061	8	6PCR-08-578	1437652-2
3.061	8	6PCR-08-006	9-1437651-9
2.686	7	6PCR-07-1175	9-1437651-4
2.686	7	6PCR-07-006	9-1437651-1
2.311	6	6PCR-06-006	8-1437651-7
1.936	5	6PCR-05-006	8-1437651-2
1.561	4	6PCR-04-006	7-1437651-7
1.186	3	6PCR-03-1368	7-1437651-2
1.186	3	6PCR-03-1367	7-1437651-4
1.186	3	6PCR-03-006	6-1437651-9
.811	2	6PCR-02-006	6-1437651-2
DIM. "A"	NO. OF POS.	CATALOG NUMBER	PART NO.

SEE FIGURE 2 OBSOLETE
 OBSOLETE
 OBSOLETE

MATERIAL:
 HOUSING: THERMOPLASTIC, UL94V-0 BLACK.
 TERMINALS: COPPER ALLOY, BRIGHT TIN PLATED.
 SCREWS: 6-32, STEEL, ZINC PLATED WITH CLR CHROMATE.

ELECTRICAL:
 MAXIMUM CURRENT: 25A.
 OPERATING VOLTAGE: 300V.
 WIRE RANGE: 12-22 AWG.
 RECOMMENDED TIGHTENING TORQUE: 7 IN-LBS.

ENVIRONMENT:
 OPERATING TEMP.: +105°C

- 1 MARKED WITH WHITE PERMANENT INK.
- 2 OBSOLETE PARTS: OBSOLETE CIS STREAMLINING PER D.RENAUD/D.SINISI

THIS DRAWING IS A CONTROLLED DOCUMENT.		DWN	S SCHLEGEL	2/10/04	TE Connectivity NAME 6PCR-XX-006			
DIMENSIONS: INCHES		CHK	S. YODER	2/10/04				
TOLERANCES UNLESS OTHERWISE SPECIFIED:		APVD	S. YODER	2/10/04				
0 PLC ± - 1 PLC ± - 2 PLC ± .02 3 PLC ± .010 4 PLC ± - ANGLES ± 1/2		PRODUCT SPEC		NAME				
MATERIAL		FINISH		APPLICATION SPEC	SIZE	CAGE CODE	DRAWING NO	RESTRICTED TO
-		-		WEIGHT	-	A3	00779	C-6-1437651-2
CUSTOMER DRAWING				SCALE	NTS	SHEET	1 OF 1	REV B4

Mouser Electronics

Authorized Distributor

Click to View Pricing, Inventory, Delivery & Lifecycle Information:

[TE Connectivity:](#)

[6PCR-03-006](#)