

General Specifications

Electrical Capacity (Resistive Load)

Power Level: 1mA @ 5.5V DC (resistive load)

Other Ratings

XY Resistive Value: 20 ~ 80Ω

Linearity: ±2.0% maximum

Insulation Impedance: 10MΩ minimum @ 25V DC

Expected Operational Life: Writing: 50,000 operations minimum (approximately 30mm movement with stylus)

Tapping: 10,000,000 operations minimum (pressing force 4.9N using silicone rubber, hardness 60°)

Touch Activation Force: 0.05 ~ 0.8N

Chattering Time: 10 milliseconds maximum

Light Transmission: 80% standard (Touch Panel portion)

Surface Hardness: 2H minimum (JIS K5600)

Environmental Data

Operating Temperature Range: -20°C ~ +70°C (-4°F ~ +158°F)

Storage Temperature Range: -40°C ~ +80°C (-40°F ~ +176°F)

Relative Humidity: +60°C (+140°F), humidity 90%, 240 hours

TYPICAL ORDERING EXAMPLE

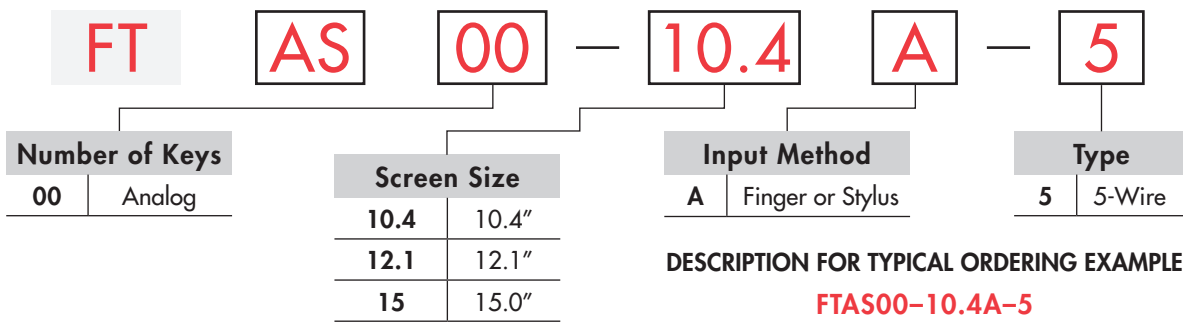

DESCRIPTION FOR TYPICAL ORDERING EXAMPLE

FTAS00-10.4A-5

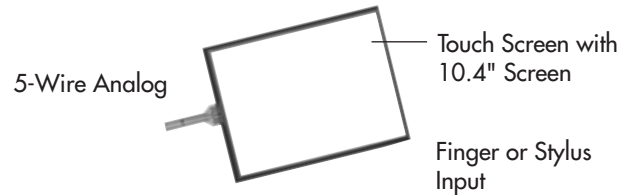

PART NUMBERS & DESCRIPTIONS

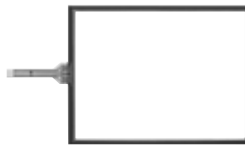

FTAS00-10.4A-5



FTAS00-12.1A-5



FTAS00-15A-5

5-Wire Analog Touch Screens

Part Number	Screen Size in Inches	Key Area Dimensions	Viewing Area Dimensions	External Dimensions	Panel Thickness	Terminal Detail 8 Pin .049" (1.25mm) Pitch
FTAS00-10.4A-5	10.4	8.5" x 6.45" (215.9mm x 163.9mm)	8.66" x 6.61" (219.9mm x 167.9mm)	9.31" x 7.22" (236.5mm x 183.3mm)	.083" (2.1mm)	Length 3.150" (80.0mm)
FTAS00-12.1A-5	12.1	9.8" x 7.37" (249.0mm x 187.2mm)	9.94" x 7.50" (252.4mm x 190.6mm)	10.52" x 8.1" (267.1mm x 205.8mm)	.083" (2.1mm)	Length 3.150" (80.0mm)
FTAS00-15A-5	15.0	12.05" x 9.06" (306.1mm x 230.1mm)	12.19" x 9.19" (309.5mm x 233.5mm)	12.79" x 9.79" (324.8mm x 248.7mm)	.083" (2.1mm)	Length 3.150" (80.0mm)

Note: See web site for dimensioned drawings for all 5-Wire Analog Touch Screens.

TYPICAL DIMENSIONS

Horizontal Tail

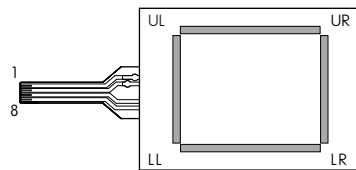
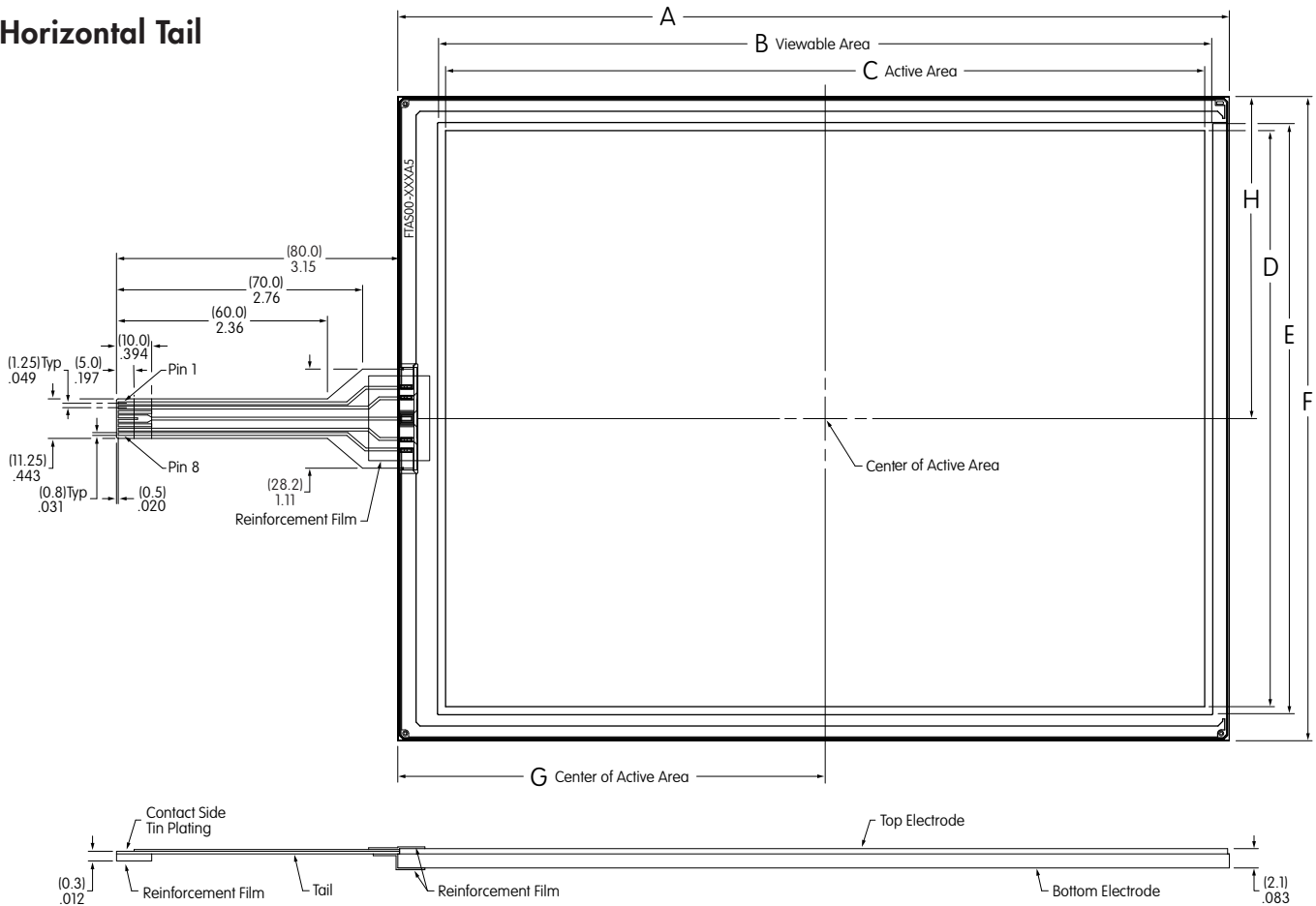

UL, LL, UR, LR: Bottom Electrode Terminal
SENSE: Top Electrode Terminal

Pins	Signal
1	UR
2	UL
3	NC
4, 5	SENSE
6	NC
7	LL
8	LR

5-Wire Analog Touch Screen Dimensions

Part Number	Screen Size in Inches	Dim A	Dim B Viewable Area	Dim C Active Area	Dim D Active Area	Dim E Viewable Area	Dim F	Dim G Center of Active Area (Horizontal)	Dim H Center of Active Area (Vertical)
FTAS00-10.4A-5	10.4	9.31" (236.5±0.3mm)	8.66" (219.9mm)	8.50" (215.9mm)	6.45" (163.9mm)	6.61" (167.9mm)	7.22" (183.3±0.3mm)	4.79" (121.55mm)	3.61" (91.65mm)
FTAS00-12.1A-5	12.1	10.52" (267.1±0.3mm)	9.94" (252.4mm)	9.80" (249.0mm)	7.37" (187.2mm)	7.50" (190.6mm)	8.10" (205.8±0.3mm)	5.37" (136.4mm)	4.05" (102.9mm)
FTAS00-15A-5	15.0	12.79" (324.8±0.3mm)	12.19" (309.5mm)	12.05" (306.1mm)	9.06" (230.1mm)	9.19" (233.5mm)	9.79" (248.7±0.3mm)	6.49" (164.95mm)	4.90" (124.35mm)

Controller Boards & Drivers

DISTINCTIVE CHARACTERISTICS

- Compatible with Control Board USB/RS232C
- Equipped with EPROM for Saving Setting Data
- Device Drivers are Windows 7, 8 & 10 Compatible

Touch panels can be operated the same as PC mouse functions by combining a control board or device driver and analog touch screen.

For specifications or technical data for the controller boards and drivers, see NKK's web site or call our engineering support personnel.

System Configuration for USB

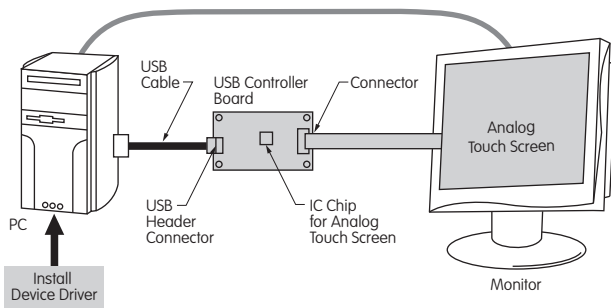

System Configuration for RS232C

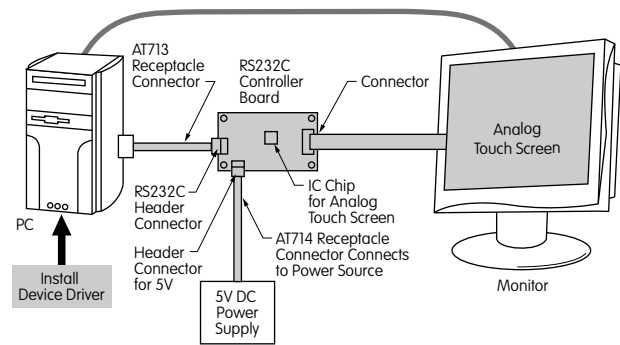

■ Available through NKK Switches

General Specifications

Items	FTCS05B	FTCU05B
Interface	RS232C	USB 2.0 Full Speed
Clock	6MHz	6MHz
Supply Voltage	5.0V	5.0V (Bus Power)
Resolution	10bit	10bit
Current Consumption	350mA maximum	350mA maximum
Communication Speed	9600 bps	—
Communication Format	Data Length: 8bit Parity: None Stop Bit: 1	—

Absolute Maximum Ratings

Items	Symbols	Minimum	Maximum	Notes
Supply Voltage	V_{CC}	-0.3V	+5.5V	—
Input Voltage	V_{TP}	—	V_{CC}	Touch Panel Input
	$*V_{RS}$	-15V	+15V	RS232C
Operating Temperature	T_{OPR}	0	+70°C +158°F	—
Storage Temperature	T_{STG}	-25°C -13°F	+85°C +185°F	—

* V_{RS} : Applies Only to RS232C

Recommended Values

Items	Symbols	Minimum	Typical	Maximum	Notes
Supply Voltage	V_{CC}	+4.75V	+5.0	+5.25V	—
Operating Temperature	T_{OPR}	0	—	+70°C +158°F	No Condensation

Controller Boards & Drivers

DISTINCTIVE CHARACTERISTICS

- High Quality and Reliability
- Easy Integration Replacing Mouse Functionality
- Compatible with Control Board USB/RS232C
- Device Driver Compatible with Vista and Windows XP Operating Systems

Controller Boards		
Type	Part No.	Communication Protocol
5-Wire	FTCS05B	RS232C
5-Wire	FTCU05B	USB

Controller Boards Available for RS232C

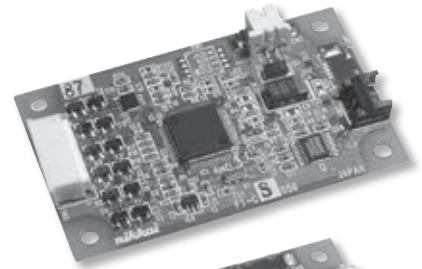

Controller Boards Available for USB

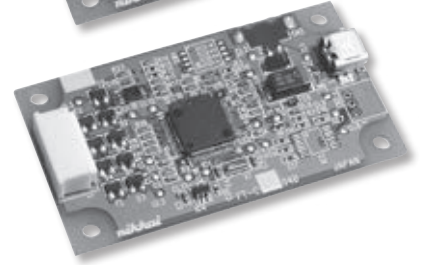

NKK offers controller boards compatible with USB or with RS232C. See web site or contact factory for specifications and technical data for any of the controller boards and drivers.

IC Chip & Accessories

DISTINCTIVE CHARACTERISTICS

- Interface: USB and RS232C
- High Speed and Accuracy
- Built-in Calibration Function
- Data Function Removal Built In to Eliminate Noise



IC FTCSU548

The IC is for use with the 5- and 4-wire transparent touch screens, and is available for those who prefer to design their own controller boards. When the screen is touched, it recognizes the position of the touch by the level of analog voltage detected by the A/D. The A/D converter receives the value and sends a set of coordinate values as serial data or USB.

General Specifications for IC FTCSU548

Package	LFQFP 48 Pins
Interface	Serial Interface (Asynchronous) or USB (Full Speed 2.0)
Supply Voltage	3.3/5.0V Typ; USB Available for 5V Only
* Rated Output Current	High Level: -170mA Low Level: +170mA
Operation Frequency	16MHz
A/D Converter Resolution	10bit
Operating Temperature	-20°C ~ +85°C (-4°F ~ +185°F)
Storage Temperature	-40°C ~ +125°C (-40°F ~ +257°F)

* Total Output Electric Current Amount of all the I/O Port

OPTIONAL ACCESSORIES

AT713 Receptacle Connector

This Receptacle Connector with code connects to RS232C communication of the controller boards.



AT714 Receptacle Connector

AT714 is a Receptacle Connector with code to connect to power source of the control boards.



For more details and dimensioned drawings of the accessories, go to NKK's web site or call our engineering support personnel.

STORAGE, HANDLING & INSTALLATION

Handling of Controller Board

- Use arc prevention to protect device from static electricity.
- Power source should be activated after host and touch panel are connected.
- When inserting connector CN1 and touch panel tail, be sure the slider of connector CN1 is pulled. Do not pull more than 10 times.
- Do not alter the product.
- Do not use any commands other than the ones outlined in the specifications.
- Place the product away from noise source (such as inverter from LCD operation) since tail can be affected by noise.
- If device driver (USB) does not work after installation, reboot the host computer while connected to the controller board.
- This product does not support suspended mode (USB).
- Protocol of USB transmission is one frame per one transaction.
- Contact factory if not using the protocol above.
- Warranty for one year after delivery. NKK warranties the 4-wire touch panel when it is used with the NKK control board and driver. Do not use third party control boards. NKK is not responsible for results of using damaged equipment with the controller boards.
- NKK Switches cannot assume responsibility for damages caused by software side during use of the touch screens.
- The touch screen pressed position may shift depending on various factors such as age, improper tail insertion or extreme temperatures. In such cases, recalibration is necessary.

Installation

- Products are ESD sensitive and ESD protection is required.
- Do not pull on the tail. Do not apply stress to the tail area.
- Avoid vibration or shock. Avoid any force or stress that may cause deformation to the product.
- The touch screen mounting should not be loose. This may cause an adverse effect on detecting performance during operation.
- Ensure there are no burrs around the edges of the case or housing that can cause false actuation. The edges of the case or housing should not enter the keying area.
- The case or housing and upper electrode should have a space of about 0.5mm to accommodate expansion or shrinkage due to temperature variances. If a shock barrier is used, do not press hard on the upper electrode area. Any shock barrier should be installed more than 0.6mm away from A.

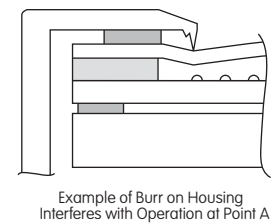
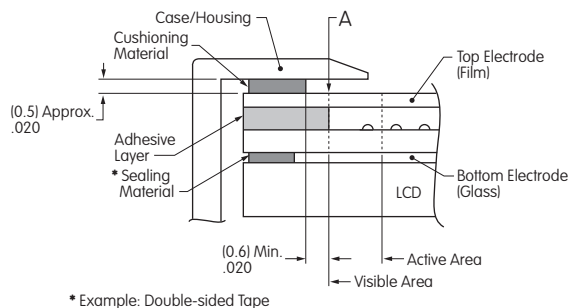

- To secure the touch screen, secure the lower portion with a device such as the LCD display panel. Do not attach the upper electrode with double-sided tape or similar product to avoid stress that can damage the upper or lower electrode.
- In order to balance upper and lower pressure, an air vent may be installed. Ensure that no liquid or oil will enter into the device.
- Avoid air pressure applied to the touch screen as it may cause the top electrode to force air through the air vent, effecting electric endurance. If pressure inside of the touch panel is reduced through the air vent, it may cause interference fringes or may remain in ON status.
- Ensure that the glass is handled carefully to prevent breakage during installation.
- Moisture from condensation on tail connection or edges may result in migration, causing short circuit failure.
- Remove protective film from the touch screen after installation is completed.

STORAGE, HANDLING & INSTALLATION

Handling Precautions

- When opening product, take precaution with up/down and front/back directions. Glass edges are not chamfered, and corners or edges can be sharp. Wear gloves when handling the product.
- Do not pick up the product by the tail or pull the tail area.
- Use gloves or finger cots to prevent fingerprints on surface.
- When handling the product, hold it outside of the viewing area.
- Avoid stacking multiple products or placing other items on the product.
- When packing or storing, the glass should be positioned face up.

Operating Precautions

- Operate with fingers or a touch screen stylus only.
- Do not press hard with a pen or similar object between viewing area and key area.

Design Precautions

- With analog type, resistive value change (by aging or individual differences) can dislocate the input area. Input area can be calibrated with software.
- When installing on top of an LCD, noise from the display device can create misoperation. To avoid noise, implement grounding the display device frame.
- Do not create software for simultaneous touch points, as analog type will read the center point between two touch points.
- When used to draw a line, analog type will have a break at dot spacer. Compensate for this with software.
- Contact resistance may cause chatter depending on pressing condition. Software should detect signal after it stabilizes.

Other Precautions

- Clean with a soft cloth and ethanol. Do not use any cleaning agents other than ethanol.
- Store product in original package and store at the temperature and humidity range specified.
- Do not store in an environment with acids or other corrosive gases or where condensation may occur.
- Products are guaranteed based on evaluation of standards within the moisture tolerance and usage temperature range, but not guaranteed to operate perpetually at this temperature.
- Note that an incorrect type of connector may damage the print surface.
- Calibration data from one touch panel should not be applied to another panel; each should be calibrated individually.
- Recalibration is necessary if connector has been removed from the tail and reconnected.
- All specifications based on the tested touch screens only. Evaluate the products after installation with customer's equipment.
- NKK Switches reserves the right to make product improvement changes without notice.

Mouser Electronics

Authorized Distributor

Click to View Pricing, Inventory, Delivery & Lifecycle Information:

NKK Switches:

[FTAS00-104A5](#) [FTAS00-121A5](#) [FTAS00-150A5](#) [FTAS00-12.1AN-4](#) [FTAS00-15AN-4](#) [FTAS00-19AN-4](#)