

# MC79M00 Series

## 500 mA Negative Voltage Regulators

The MC79M00 series of fixed output negative voltage regulators are intended as complements to the popular MC78M00 series devices.

Available in fixed output voltage options of  $-5.0\text{ V}$ ,  $-8.0\text{ V}$ ,  $-12\text{ V}$  and  $-15\text{ V}$ , these regulators employ current limiting, thermal shutdown, and safe-area compensation, making them remarkably rugged under most operating conditions. With adequate heatsinking they can deliver output currents in excess of  $0.5\text{ A}$ .

### Features

- No External Components Required
- Internal Thermal Overload Protection
- Internal Short Circuit Current Limiting
- Output Transistor Safe-Area Compensation
- Also Available in Surface Mount DPAK (DT) Package
- Pb-Free Packages are Available

### DEVICE TYPE/NOMINAL OUTPUT VOLTAGE

Device	Nominal Output Voltage
MC79M05	$-5.0\text{ V}$
MC79M08	$-8.0\text{ V}$
MC79M12	$-12\text{ V}$
MC79M15	$-15\text{ V}$

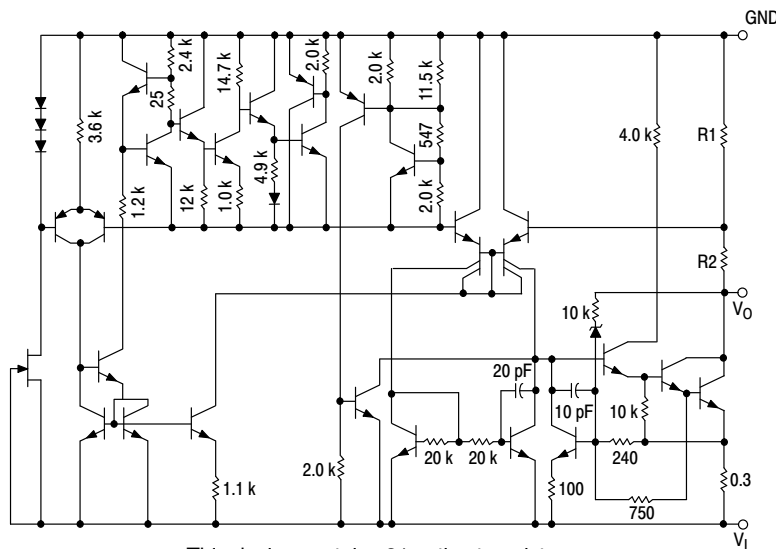

This device contains 31 active transistors.

Figure 1. Representative Schematic Diagram



ON Semiconductor®

<http://onsemi.com>

### THREE-TERMINAL NEGATIVE FIXED VOLTAGE REGULATORS

#### STANDARD APPLICATION

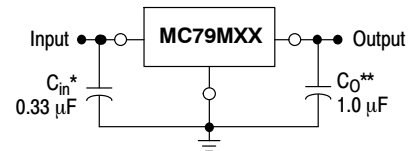

A common ground is required between the input and the output voltages. The input voltage must remain typically  $1.1\text{ V}$  more negative even during the high point of the input ripple voltage.

XX These two digits of the type number indicate nominal voltage.

\*  $C_{in}$  is required if regulator is located an appreciable distance from power supply filter.

\*\*  $C_O$  improve stability and transient response.

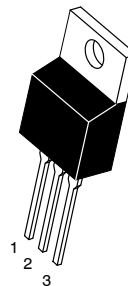

TO-220-3  
T SUFFIX  
CASE 221AB

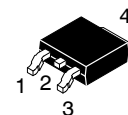

DPAK-3  
DT SUFFIX  
CASE 369C

### MARKING DIAGRAMS

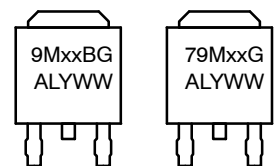
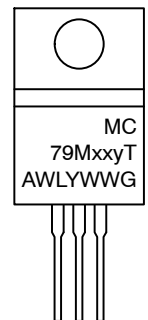

xx = 05, 08, 12, or 15  
y = B or C  
A = Assembly Location  
WL, L = Wafer Lot  
Y = Year  
WW = Work Week  
G = Pb-Free Device

### ORDERING INFORMATION

See detailed ordering and shipping information in the package dimensions section on page 6 of this data sheet.

## MC79M00 Series

### MAXIMUM RATINGS ( $T_A = 25^\circ\text{C}$ , unless otherwise noted.)

Rating	Symbol	Value	Unit
Input Voltage	$V_I$	-35	Vdc
Power Dissipation			
Case 221A (TO-220-3)			
$T_A = 25^\circ\text{C}$	$P_D$	Internally Limited	W
Thermal Resistance, Junction-to-Ambient	$\theta_{JA}$	65	$^\circ\text{C/W}$
Thermal Resistance, Junction-to-Case	$\theta_{JC}$	5.0	$^\circ\text{C/W}$
Case 369C (DPAK-3)			
$T_A = 25^\circ\text{C}$	$P_D$	Internally Limited	W
Thermal Resistance, Junction-to-Ambient	$\theta_{JA}$	92	$^\circ\text{C/W}$
Thermal Resistance, Junction-to-Case	$\theta_{JC}$	6.0	$^\circ\text{C/W}$
Storage Junction Temperature	$T_{stg}$	-65 to +150	$^\circ\text{C}$
Operating Junction Temperature Range	$T_J$	-40 to +150	$^\circ\text{C}$

Stresses exceeding Maximum Ratings may damage the device. Maximum Ratings are stress ratings only. Functional operation above the Recommended Operating Conditions is not implied. Extended exposure to stresses above the Recommended Operating Conditions may affect device reliability.

\*This device series contains ESD protection and exceeds the following tests:

- Human Body Model 2000 V per MIL\_STD\_883, Method 3015
- Machine Model Method 200 V

### MC79M05B, C

#### ELECTRICAL CHARACTERISTICS ( $V_I = -10\text{ V}$ , $I_O = 350\text{ mA}$ , $T_{low}$ to $T_{high}$ (Note 2), unless otherwise noted.)

Characteristic	Symbol	Min	Typ	Max	Unit
Output Voltage ( $T_J = 25^\circ\text{C}$ )	$V_O$	-4.8	-5.0	-5.2	Vdc
Line Regulation, $T_J = 25^\circ\text{C}$ (Note 1) -7.0 Vdc $\geq V_I \geq$ -25 Vdc -8.0 Vdc $\geq V_I \geq$ -18 Vdc	$Reg_{line}$	-	7.0 2.0	50 30	mV
Load Regulation, $T_J = 25^\circ\text{C}$ (Note 1) $5.0\text{ mA} \leq I_O \leq 500\text{ mA}$	$Reg_{load}$	-	30	100	mV
Output Voltage -7.0 Vdc $\geq V_I \geq$ -25 Vdc, $5.0\text{ mA} \leq I_O \leq 350\text{ mA}$	$V_O$	-4.75	-	-5.25	Vdc
Input Bias Current ( $T_J = 25^\circ\text{C}$ )	$I_{IB}$	-	4.3	8.0	mA
Input Bias Current Change -8.0 Vdc $\geq V_I \geq$ -25 Vdc, $I_O = 350\text{ mA}$ $5.0\text{ mA} \leq I_O \leq 350\text{ mA}$ , $V_I = -10\text{ V}$	$\Delta I_{IB}$	-	-	0.4 0.4	mA
Output Noise Voltage, $T_A = 25^\circ\text{C}$ , $10\text{ Hz} \leq f \leq 100\text{ kHz}$	$V_n$	-	40	-	$\mu\text{V}$
Ripple Rejection ( $f = 120\text{ Hz}$ )	RR	54	66	-	dB
Dropout Voltage $I_O = 500\text{ mA}$ , $T_J = 25^\circ\text{C}$	$V_I - V_O$	-	1.1	-	Vdc
Average Temperature Coefficient of Output Voltage $I_O = 5.0\text{ mA}$ , $0^\circ\text{C} \leq T_J \leq 125^\circ\text{C}$	$\Delta V_O / \Delta T$	-	0.2	-	$\text{mV}/^\circ\text{C}$

1. Load and line regulation are specified at constant temperature. Change in  $V_O$  due to heating effects must be taken into account separately. Pulse testing with low duty cycle is used.
2. B =  $T_{low}$  to  $T_{high}$ ,  $-40^\circ\text{C} < T_J < 125^\circ\text{C}$  C =  $T_{low}$  to  $T_{high}$ ,  $0^\circ\text{C} < T_J < 125^\circ\text{C}$ .

## MC79M00 Series

### MC79M08B, C

**ELECTRICAL CHARACTERISTICS** ( $V_I = -10\text{ V}$ ,  $I_O = 350\text{ mA}$ ,  $T_{low}$  to  $T_{high}$  (Note 4), unless otherwise noted.)

Characteristic	Symbol	Min	Typ	Max	Unit
Output Voltage ( $T_J = 25^\circ\text{C}$ )	$V_O$	-7.7	-8.0	-8.3	Vdc
Line Regulation, $T_J = 25^\circ\text{C}$ (Note 3) -10.5 Vdc $\geq V_I \geq$ -25 Vdc -11 Vdc $\geq V_I \geq$ -21 Vdc	$\text{Reg}_{line}$	-	5.0 3.0	80 50	mV
Load Regulation, $T_J = 25^\circ\text{C}$ (Note 3) $5.0\text{ mA} \leq I_O \leq 500\text{ mA}$	$\text{Reg}_{load}$	-	30	100	mV
Output Voltage -10.5 Vdc $\geq V_I \geq$ -25 Vdc, $5.0\text{ mA} \leq I_O \leq 350\text{ mA}$	$V_O$	-7.6	-8.0	-8.4	Vdc
Input Bias Current ( $T_J = 25^\circ\text{C}$ )	$I_{IB}$	-	-	8.0	mA
Input Bias Current Change -10.5 Vdc $\geq V_I \geq$ -25 Vdc, $I_O = 350\text{ mA}$ $5.0\text{ mA} \leq I_O \leq 350\text{ mA}$ , $V_I = -10\text{ V}$	$\Delta I_{IB}$	-	-	0.4 0.4	mA
Output Noise Voltage, $T_A = 25^\circ\text{C}$ , $10\text{ Hz} \leq f \leq 100\text{ kHz}$	$V_n$	-	60	-	$\mu\text{V}$
Ripple Rejection ( $f = 120\text{ Hz}$ )	RR	54	63	-	dB
Dropout Voltage $I_O = 500\text{ mA}$ , $T_J = 25^\circ\text{C}$	$V_I - V_O$	-	1.1	-	Vdc
Average Temperature Coefficient of Output Voltage $I_O = 5.0\text{ mA}$ , $0^\circ\text{C} \leq T_J \leq 125^\circ\text{C}$	$\Delta V_O / \Delta T$	-	0.4	-	$\text{mV}/^\circ\text{C}$

3. Load and line regulation are specified at constant temperature. Change in  $V_O$  due to heating effects must be taken into account separately. Pulse testing with low duty cycle is used.
4. B =  $T_{low}$  to  $T_{high}$ ,  $-40^\circ\text{C} < T_J < 125^\circ\text{C}$   
C =  $T_{low}$  to  $T_{high}$ ,  $0^\circ\text{C} < T_J < 125^\circ\text{C}$

### MC79M12B, C

**ELECTRICAL CHARACTERISTICS** ( $V_I = -19\text{ V}$ ,  $I_O = 350\text{ mA}$ ,  $T_{low}$  to  $T_{high}$  (Note 6), unless otherwise noted.)

Characteristic	Symbol	Min	Typ	Max	Unit
Output Voltage ( $T_J = 25^\circ\text{C}$ )	$V_O$	-11.5	-12	-12.5	Vdc
Line Regulation, $T_J = 25^\circ\text{C}$ (Note 5) -14.5 Vdc $\geq V_I \geq$ -30 Vdc -15 Vdc $\geq V_I \geq$ -25 Vdc	$\text{Reg}_{line}$	-	5.0 3.0	80 50	mV
Load Regulation, $T_J = 25^\circ\text{C}$ (Note 5) $5.0\text{ mA} \leq I_O \leq 500\text{ mA}$	$\text{Reg}_{load}$	-	30	240	mV
Output Voltage -14.5 Vdc $\geq V_I \geq$ -30 Vdc, $5.0\text{ mA} \leq I_O \leq 350\text{ mA}$	$V_O$	-11.4	-	-12.6	Vdc
Input Bias Current ( $T_J = 25^\circ\text{C}$ )	$I_{IB}$	-	4.4	8.0	mA
Input Bias Current Change -14.5 Vdc $\geq V_I \geq$ -30 Vdc, $I_O = 350\text{ mA}$ $5.0\text{ mA} \leq I_O \leq 350\text{ mA}$ , $V_I = -19\text{ V}$	$\Delta I_{IB}$	-	-	0.4 0.4	mA
Output Noise Voltage, $T_A = 25^\circ\text{C}$ , $10\text{ Hz} \leq f \leq 100\text{ kHz}$	$V_n$	-	75	-	$\mu\text{V}$
Ripple Rejection ( $f = 120\text{ Hz}$ )	RR	54	60	-	dB
Dropout Voltage $I_O = 500\text{ mA}$ , $T_J = 25^\circ\text{C}$	$V_I - V_O$	-	1.1	-	Vdc
Average Temperature Coefficient of Output Voltage $I_O = 5.0\text{ mA}$ , $0^\circ\text{C} \leq T_J \leq 125^\circ\text{C}$	$\Delta V_O / \Delta T$	-	-0.8	-	$\text{mV}/^\circ\text{C}$

5. Load and line regulation are specified at constant temperature. Change in  $V_O$  due to heating effects must be taken into account separately. Pulse testing with low duty cycle is used.
6. B =  $T_{low}$  to  $T_{high}$ ,  $-40^\circ\text{C} < T_J < 125^\circ\text{C}$   
C =  $T_{low}$  to  $T_{high}$ ,  $0^\circ\text{C} < T_J < 125^\circ\text{C}$

## MC79M00 Series

### MC79M15B, C

**ELECTRICAL CHARACTERISTICS** ( $V_I = -23\text{ V}$ ,  $I_O = 350\text{ mA}$ ,  $T_{low}$  to  $T_{high}$  (Note 8), unless otherwise noted.)

Characteristic	Symbol	Min	Typ	Max	Unit
Output Voltage ( $T_J = 25^\circ\text{C}$ )	$V_O$	-14.4	-15	-15.6	Vdc
Line Regulation, $T_J = 25^\circ\text{C}$ (Note 7) -17.5 Vdc $\geq V_I \geq$ -30 Vdc -18 Vdc $\geq V_I \geq$ -28 Vdc	$Reg_{line}$	-	5.0 3.0	80 50	mV
Load Regulation, $T_J = 25^\circ\text{C}$ (Note 7) $5.0\text{ mA} \leq I_O \leq 500\text{ mA}$	$Reg_{load}$	-	30	240	mV
Output Voltage -17.5 Vdc $\geq V_I \geq$ -30 Vdc, $5.0\text{ mA} \leq I_O \leq 350\text{ mA}$	$V_O$	-14.25	-	-15.75	Vdc
Input Bias Current ( $T_J = 25^\circ\text{C}$ )	$I_{IB}$	-	4.4	8.0	mA
Input Bias Current Change -17.5 Vdc $\geq V_I \geq$ -30 Vdc, $I_O = 350\text{ mA}$ $5.0\text{ mA} \leq I_O \leq 350\text{ mA}$ , $V_I = -23\text{ V}$	$\Delta I_{IB}$	-	-	0.4 0.4	mA
Output Noise Voltage, $T_A = 25^\circ\text{C}$ , $10\text{ Hz} \leq f \leq 100\text{ kHz}$	$V_n$	-	90	-	$\mu\text{V}$
Ripple Rejection ( $f = 120\text{ Hz}$ )	RR	54	60	-	dB
Dropout Voltage $I_O = 500\text{ mA}$ , $T_J = 25^\circ\text{C}$	$V_I - V_O$	-	1.1	-	Vdc
Average Temperature Coefficient of Output Voltage $I_O = 5.0\text{ mA}$ , $0^\circ\text{C} \leq T_J \leq 125^\circ\text{C}$	$\Delta V_O / \Delta T$	-	-1.0	-	$\text{mV}/^\circ\text{C}$

7. Load and line regulation are specified at constant temperature. Change in  $V_O$  due to heating effects must be taken into account separately. Pulse testing with low duty cycle is used.
8. B =  $T_{low}$  to  $T_{high}$ ,  $-40^\circ\text{C} < T_J < 125^\circ\text{C}$   
C =  $T_{low}$  to  $T_{high}$ ,  $0^\circ\text{C} < T_J < 125^\circ\text{C}$

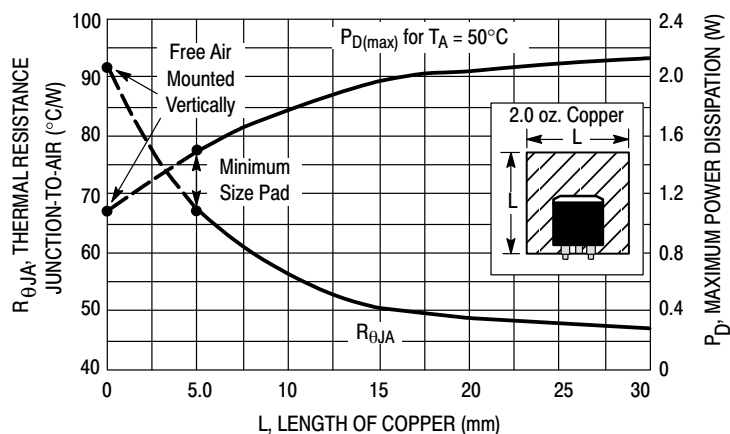

**Figure 1. DPAK-3 Thermal Resistance and Maximum Power Dissipation versus P.C.B. Copper Length**

## MC79M00 Series

### Protection Diodes

When external capacitors are used with MC79M00 series regulator it is sometimes necessary to add protection diodes to prevent the capacitors from discharging through low current points into the regulator or from output polarity reversals. Generally, no protection diode is required for values of output capacitance less than  $10\mu\text{F}$ . Figure 2 shows the MC79M15 with the recommended protection diodes.

- Opposite Polarity Protection

Diode D1 protects the regulator from output polarity reversals during startup, power off and short-circuit operation.

- Reverse-bias Protection

Diode D2 prevents output capacitor from discharging through the MC79M15 during an input short circuit or fast switch off of power supply.

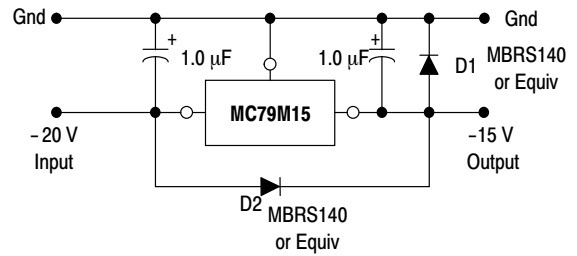

**Figure 2. Protection Diodes**

## MC79M00 Series

### ORDERING INFORMATION

Device	Output Voltage Tolerance	Operating Temperature Range	Package	Shipping <sup>†</sup>
MC79M05BDT	4.0%	$T_J = -40^{\circ}\text{C to } +125^{\circ}\text{C}$	DPAK	75 Units / Rail
MC79M05BDTG			DPAK (Pb-Free)	75 Units / Rail
MC79M05BDTRK			DPAK	2500 Units / Reel
MC79M05BDTRKG			DPAK (Pb-Free)	2500 Units / Reel
MC79M05BT			TO-220	50 Units / Rail
MC79M05BTG			TO-220 (Pb-Free)	50 Units / Rail
MC79M05CDT		$T_J = 0^{\circ}\text{C to } +125^{\circ}\text{C}$	DPAK	75 Units / Rail
MC79M05CDTG			DPAK (Pb-Free)	75 Units / Rail
MC79M05CDTRK			DPAK	2500 Units / Reel
MC79M05CDTRKG			DPAK (Pb-Free)	2500 Units / Reel
MC79M05CT			TO-220	50 Units / Rail
MC79M05CTG			TO-220 (Pb-Free)	50 Units / Rail
MC79M08BDT		$T_J = -40^{\circ}\text{C to } +125^{\circ}\text{C}$	DPAK	75 Units / Rail
MC79M08BDTRK			DPAK	2500 Units / Reel
MC79M08BDTRKG			DPAK (Pb-Free)	2500 Units / Reel
MC79M08BT			TO-220	50 Units / Rail
MC79M08BTG			TO-220 (Pb-Free)	50 Units / Rail
MC79M08CDT			$T_J = 0^{\circ}\text{C to } +125^{\circ}\text{C}$	DPAK
MC79M08CDTG		DPAK (Pb-Free)		75 Units / Rail
MC79M08CDTRK		DPAK		2500 Units / Reel
MC79M08CDTRKG		DPAK (Pb-Free)		2500 Units / Reel
MC79M08CT		TO-220		50 Units / Rail
MC79M08CTG		TO-220 (Pb-Free)		50 Units / Rail
MC79M12BDT		$T_J = -40^{\circ}\text{C to } +125^{\circ}\text{C}$	DPAK	75 Units / Rail
MC79M12BDTG			DPAK (Pb-Free)	75 Units / Rail
MC79M12BDTRK			DPAK	2500 Units / Reel
MC79M12BDTRKG			DPAK (Pb-Free)	2500 Units / Reel
MC79M12BT			TO-220	50 Units / Rail
MC79M12BTG			TO-220 (Pb-Free)	50 Units / Rail
MC79M12CDT		$T_J = 0^{\circ}\text{C to } +125^{\circ}\text{C}$	DPAK	75 Units / Rail
MC79M12CDTG	DPAK (Pb-Free)		75 Units / Rail	
MC79M12CDTRK	DPAK		2500 Units / Reel	
MC79M12CDTRKG	DPAK (Pb-Free)		2500 Units / Reel	
MC79M12CT	TO-220		50 Units / Rail	
MC79M12CTG	TO-220 (Pb-Free)		50 Units / Rail	

<sup>†</sup>For information on tape and reel specifications, including part orientation and tape sizes, please refer to our Tape and Reel Packaging Specifications Brochure, BRD8011/D.

## MC79M00 Series

### ORDERING INFORMATION

Device	Output Voltage Tolerance	Operating Temperature Range	Package	Shipping†
MC79M15BDT	4.0%	$T_J = -40^{\circ}\text{C}$ to $+125^{\circ}\text{C}$	DPAK	75 Units / Rail
MC79M15BDTG			DPAK (Pb-Free)	75 Units / Rail
MC79M15BDTRK			DPAK	2500 Units / Reel
MC79M15BDTRKG			DPAK (Pb-Free)	2500 Units / Reel
MC79M15BT			TO-220	50 Units / Rail
MC79M15BTG			TO-220 (Pb-Free)	50 Units / Rail
MC79M15CDT		$T_J = 0^{\circ}\text{C}$ to $+125^{\circ}\text{C}$	DPAK	75 Units / Rail
MC79M15CDTG			DPAK (Pb-Free)	75 Units / Rail
MC79M15CDTRK			DPAK	2500 Units / Reel
MC79M15CDTRKG			DPAK (Pb-Free)	2500 Units / Reel
MC79M15CT			TO-220	50 Units / Rail
MC79M15CTG			TO-220 (Pb-Free)	50 Units / Rail

†For information on tape and reel specifications, including part orientation and tape sizes, please refer to our Tape and Reel Packaging Specifications Brochure, BRD8011/D.

# MC79M00 Series

## PACKAGE DIMENSIONS

### TO-220, SINGLE GAUGE CASE 221AB ISSUE A

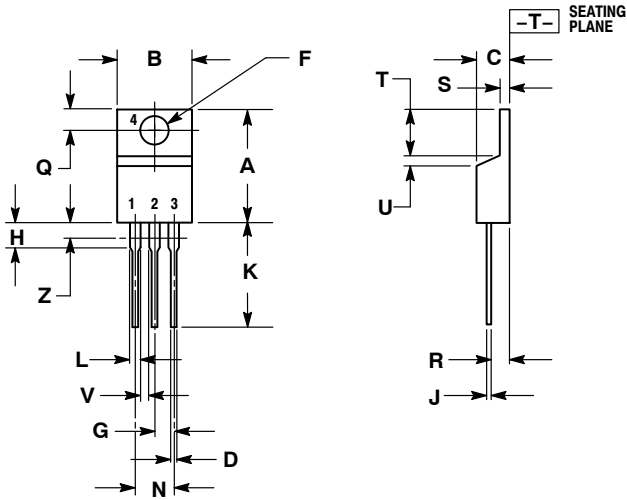

- NOTES:
1. DIMENSIONING AND TOLERANCING PER ANSI Y14.5M, 1982.
  2. CONTROLLING DIMENSION: INCHES.
  3. DIMENSION Z DEFINES A ZONE WHERE ALL BODY AND LEAD IRREGULARITIES ARE ALLOWED.
  4. PRODUCT SHIPPED PRIOR TO 2008 HAD DIMENSIONS S = 0.045 - 0.055 INCHES (1.143 - 1.397 MM)

DIM	INCHES		MILLIMETERS	
	MIN	MAX	MIN	MAX
A	0.570	0.620	14.48	15.75
B	0.380	0.405	9.66	10.28
C	0.160	0.190	4.07	4.82
D	0.025	0.035	0.64	0.88
F	0.142	0.147	3.61	3.73
G	0.095	0.105	2.42	2.66
H	0.110	0.155	2.80	3.93
J	0.018	0.025	0.46	0.64
K	0.500	0.562	12.70	14.27
L	0.045	0.060	1.15	1.52
N	0.190	0.210	4.83	5.33
Q	0.100	0.120	2.54	3.04
R	0.080	0.110	2.04	2.79
S	0.020	0.024	0.508	0.61
T	0.235	0.255	5.97	6.47
U	0.000	0.050	0.00	1.27
V	0.045	---	1.15	---
Z	---	0.080	---	2.04



# MC79M00 Series

## PACKAGE DIMENSIONS

DPAK-3  
DT SUFFIX  
CASE 369C  
ISSUE D

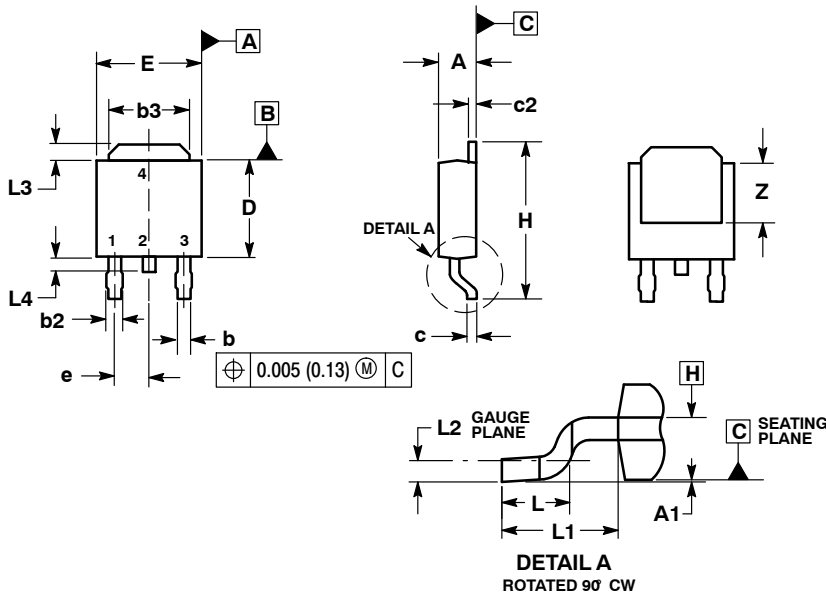

NOTES:

1. DIMENSIONING AND TOLERANCING PER ASME Y14.5M, 1994.
2. CONTROLLING DIMENSION: INCHES.
3. THERMAL PAD CONTOUR OPTIONAL WITHIN DIMENSIONS b3, L3 and Z.
4. DIMENSIONS D AND E DO NOT INCLUDE MOLD FLASH, PROTRUSIONS, OR BURRS. MOLD FLASH, PROTRUSIONS, OR GATE BURRS SHALL NOT EXCEED 0.006 INCHES PER SIDE.
5. DIMENSIONS D AND E ARE DETERMINED AT THE OUTERMOST EXTREMES OF THE PLASTIC BODY.
6. DATUMS A AND B ARE DETERMINED AT DATUM PLANE H.

DIM	INCHES		MILLIMETERS	
	MIN	MAX	MIN	MAX
A	0.086	0.094	2.18	2.38
A1	0.000	0.005	0.00	0.13
b	0.025	0.035	0.63	0.89
b2	0.030	0.045	0.76	1.14
b3	0.180	0.215	4.57	5.46
c	0.018	0.024	0.46	0.61
c2	0.018	0.024	0.46	0.61
D	0.235	0.245	5.97	6.22
E	0.250	0.265	6.35	6.73
e	0.090	BSC	2.29	BSC
H	0.370	0.410	9.40	10.41
L	0.055	0.070	1.40	1.78
L1	0.108	REF	2.74	REF
L2	0.020	BSC	0.51	BSC
L3	0.035	0.050	0.89	1.27
L4	---	0.040	---	1.01
Z	0.155	---	3.93	---

### SOLDERING FOOTPRINT\*

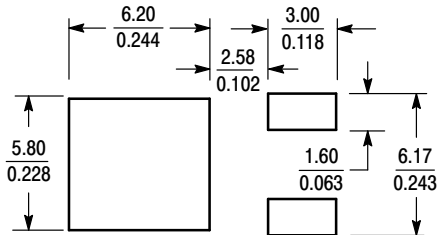

SCALE 3:1 (mm / inches)

\*For additional information on our Pb-Free strategy and soldering details, please download the ON Semiconductor Soldering and Mounting Techniques Reference Manual, SOLDERRM/D.

ON Semiconductor and are registered trademarks of Semiconductor Components Industries, LLC (SCILLC). SCILLC owns the rights to a number of patents, trademarks, copyrights, trade secrets, and other intellectual property. A listing of SCILLC's product/patent coverage may be accessed at [www.onsemi.com/site/pdf/Patent-Marketing.pdf](http://www.onsemi.com/site/pdf/Patent-Marketing.pdf). SCILLC reserves the right to make changes without further notice to any products herein. SCILLC makes no warranty, representation or guarantee regarding the suitability of its products for any particular purpose, nor does SCILLC assume any liability arising out of the application or use of any product or circuit, and specifically disclaims any and all liability, including without limitation special, consequential or incidental damages. "Typical" parameters which may be provided in SCILLC data sheets and/or specifications can and do vary in different applications and actual performance may vary over time. All operating parameters, including "Typicals" must be validated for each customer application by customer's technical experts. SCILLC does not convey any license under its patent rights nor the rights of others. SCILLC products are not designed, intended, or authorized for use as components in systems intended for surgical implant into the body, or other applications intended to support or sustain life, or for any other application in which the failure of the SCILLC product could create a situation where personal injury or death may occur. Should Buyer purchase or use SCILLC products for any such unintended or unauthorized application, Buyer shall indemnify and hold SCILLC and its officers, employees, subsidiaries, affiliates, and distributors harmless against all claims, costs, damages, and expenses, and reasonable attorney fees arising out of, directly or indirectly, any claim of personal injury or death associated with such unintended or unauthorized use, even if such claim alleges that SCILLC was negligent regarding the design or manufacture of the part. SCILLC is an Equal Opportunity/Affirmative Action Employer. This literature is subject to all applicable copyright laws and is not for resale in any manner.

### PUBLICATION ORDERING INFORMATION

**LITERATURE FULFILLMENT:**  
Literature Distribution Center for ON Semiconductor  
P.O. Box 5163, Denver, Colorado 80217 USA  
**Phone:** 303-675-2175 or 800-344-3860 Toll Free USA/Canada  
**Fax:** 303-675-2176 or 800-344-3867 Toll Free USA/Canada  
**Email:** [orderlit@onsemi.com](mailto:orderlit@onsemi.com)

**N. American Technical Support:** 800-282-9855 Toll Free  
USA/Canada  
**Europe, Middle East and Africa Technical Support:**  
Phone: 421 33 790 2910  
**Japan Customer Focus Center**  
Phone: 81-3-5817-1050

**ON Semiconductor Website:** [www.onsemi.com](http://www.onsemi.com)  
**Order Literature:** <http://www.onsemi.com/orderlit>

For additional information, please contact your local Sales Representative

# Mouser Electronics

Authorized Distributor

Click to View Pricing, Inventory, Delivery & Lifecycle Information:

## ON Semiconductor:

[MC79M05BDTG](#) [MC79M05BDTRKG](#) [MC79M05BTG](#) [MC79M05CDTG](#) [MC79M05CDTRKG](#) [MC79M05CTG](#)  
[MC79M08BDTG](#) [MC79M08BDTRKG](#) [MC79M08BTG](#) [MC79M08CDTG](#) [MC79M08CDTRKG](#) [MC79M08CTG](#)  
[MC79M12BDTG](#) [MC79M12BDTRKG](#) [MC79M12BTG](#) [MC79M12CDTG](#) [MC79M12CDTRKG](#) [MC79M12CTG](#)  
[MC79M15BDTG](#) [MC79M15BDTRKG](#) [MC79M15BTG](#) [MC79M15CDTG](#) [MC79M15CDTRKG](#) [MC79M15CTG](#)