

## Features

- Surface Mount
- 2 Way 0 degree
- 260°C Reflow Compatible
- RoHS\* Compliant
- Available on Tape and Reel.

## Description

M/A-COM's MAPDCT0029 is 2 way 0 degree RF power divider in a low cost, surface mount package. A 160 Ohm resistor included on the component. Ideally suited for high volume CATV/Broadband applications.

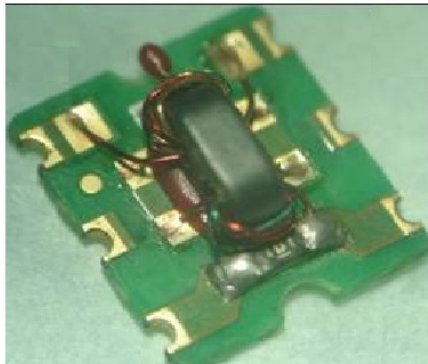

## Functional Block Diagram

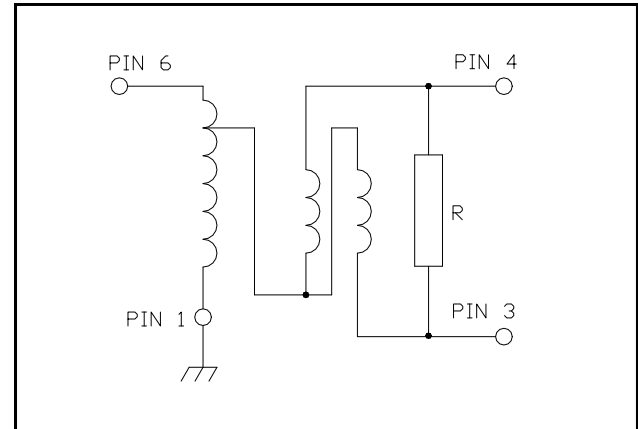

## Pin Configuration

Pin No.	Function
1	Ground
2	Not connected (ground)
3	Output 2
4	Output 1
5	Not connected (ground)
6	Input

## Ordering Information

Part Number	Package
MAPDCT0029TR	900 piece reel

Reference Application Note M513 for reel size information.

## Absolute Maximum Ratings <sup>1,2</sup>

Parameter	Absolute Maximum
Max Input Power	1W
DC current	240mA
Operating Temperature	-40°C to +85°C
Storage Temperature	-55°C to +100°C

1. Exceeding any one or combination of these limits may cause permanent damage to this device.
2. M/A-COM does not recommend sustained operation near these survivability limits.

\* Restrictions on Hazardous Substances, European Union Directive 2002/95/EC.

## 2 Way 0° Power Divider 5-1000MHz

Rev. V3

Electrical Specifications:  $T_A = 25^\circ\text{C}$ ,  $Z_0 = 75\Omega$  <sup>1</sup>

Parameter	Test Conditions	Frequency	Units	Min	Typ	Max
Insertion Loss	-	5 - 500 MHz	dB	-	0.5	0.7
Insertion Loss	-	500 - 1000 MHz	dB	-	0.7	1.4
Amplitude Unbalance (Nominal 0dB)	-	5 - 1000 MHz	dB	-	± 0.28	± 0.55
Phase Unbalance (Nominal 0°)	-	5 - 1000 MHz	°	-	± 1.0	± 3.0
Return Loss: Input	-	5 - 50 MHz	dB	24	35	-
Return Loss: Input	-	50 - 870 MHz	dB	14	26	-
Return Loss: Input	-	870 - 1000 MHz	dB	11	16	-
Return Loss: Output	-	5 - 1000 MHz	dB	15	22.5	-
Isolation (between outputs)	-	5 - 50 MHz	dB	20	26	-
Isolation (between outputs)	-	50 - 870 MHz	dB	14	22	-
Isolation (between outputs)	-	870 - 1000 MHz	dB	12	15	-

### Case Style: SM-55

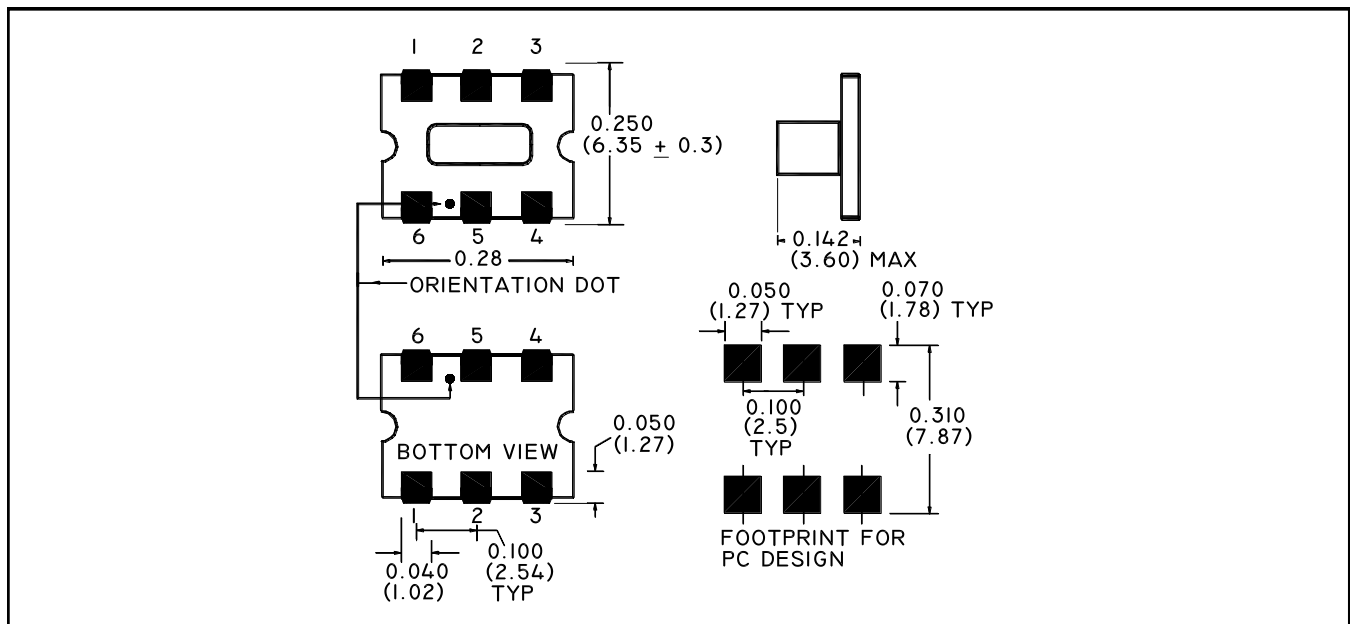

Typical Performance Curves:  $T_A = 25^\circ\text{C}$ ,  $Z_0 = 75\Omega$  <sup>1</sup>

**Insertion Loss**

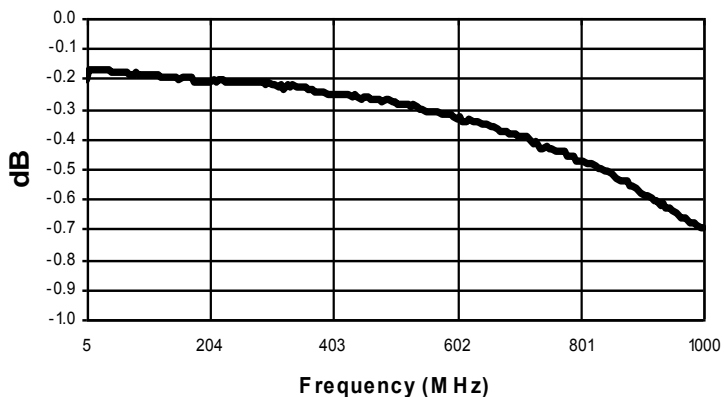

**Isolation**

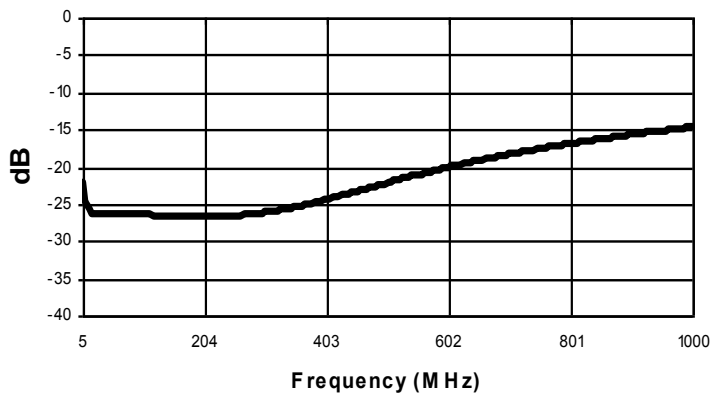

**Amplitude Unbalance**

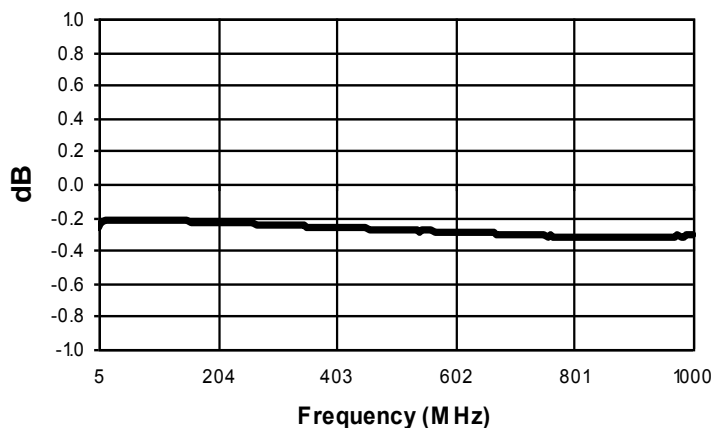

**Phase Unbalance**

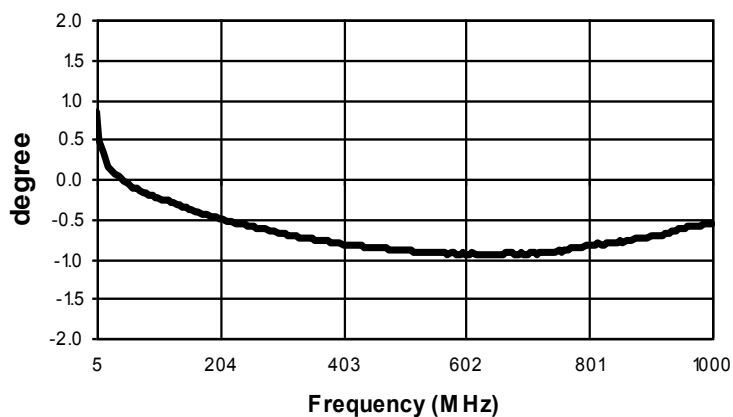

**Return Loss: Input**

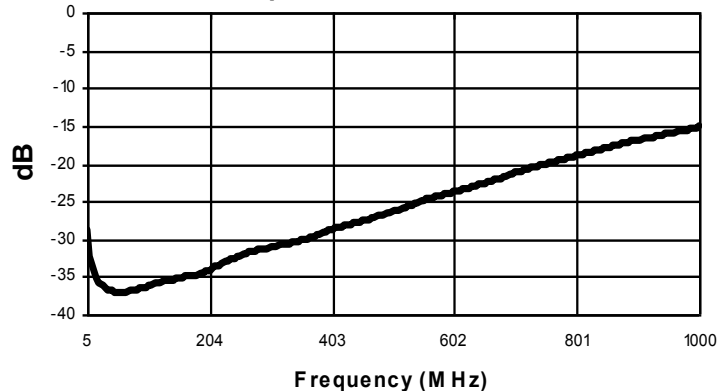

**Return Loss: Output**

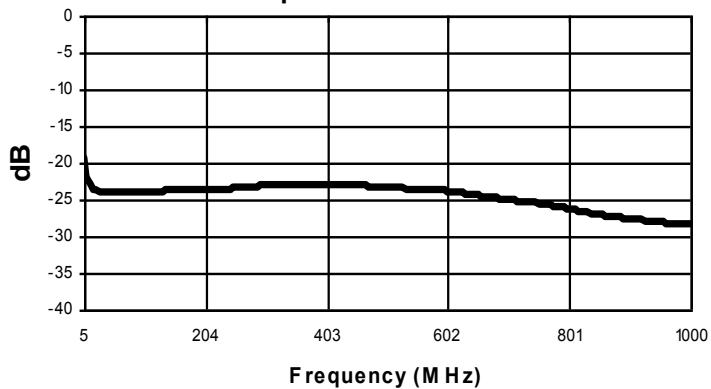

M/A-COM Technology Solutions Inc. All rights reserved.

Information in this document is provided in connection with M/A-COM Technology Solutions Inc ("MACOM") products. These materials are provided by MACOM as a service to its customers and may be used for informational purposes only. Except as provided in MACOM's Terms and Conditions of Sale for such products or in any separate agreement related to this document, MACOM assumes no liability whatsoever. MACOM assumes no responsibility for errors or omissions in these materials. MACOM may make changes to specifications and product descriptions at any time, without notice. MACOM makes no commitment to update the information and shall have no responsibility whatsoever for conflicts or incompatibilities arising from future changes to its specifications and product descriptions. No license, express or implied, by estoppel or otherwise, to any intellectual property rights is granted by this document.

THESE MATERIALS ARE PROVIDED "AS IS" WITHOUT WARRANTY OF ANY KIND, EITHER EXPRESS OR IMPLIED, RELATING TO SALE AND/OR USE OF MACOM PRODUCTS INCLUDING LIABILITY OR WARRANTIES RELATING TO FITNESS FOR A PARTICULAR PURPOSE, CONSEQUENTIAL OR INCIDENTAL DAMAGES, MERCHANTABILITY, OR INFRINGEMENT OF ANY PATENT, COPYRIGHT OR OTHER INTELLECTUAL PROPERTY RIGHT. MACOM FURTHER DOES NOT WARRANT THE ACCURACY OR COMPLETENESS OF THE INFORMATION, TEXT, GRAPHICS OR OTHER ITEMS CONTAINED WITHIN THESE MATERIALS. MACOM SHALL NOT BE LIABLE FOR ANY SPECIAL, INDIRECT, INCIDENTAL, OR CONSEQUENTIAL DAMAGES, INCLUDING WITHOUT LIMITATION, LOST REVENUES OR LOST PROFITS, WHICH MAY RESULT FROM THE USE OF THESE MATERIALS.

MACOM products are not intended for use in medical, lifesaving or life sustaining applications. MACOM customers using or selling MACOM products for use in such applications do so at their own risk and agree to fully indemnify MACOM for any damages resulting from such improper use or sale.