

# PN Series Alternate & Momentary Action Pushbutton Switches



## Features/Benefits

- Momentary or locking action
- Different actuation forces for customized feel
- Low cost, reliable contact design
- Single and double pole options
- RoHS compliant

## Typical Applications

- Computers and peripherals
- Instrumentation and measurement equipment
- Non-power, on-off switch applications

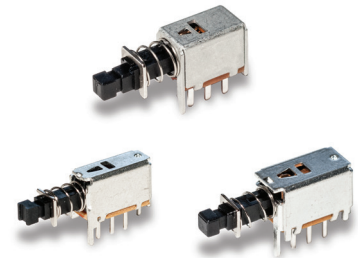

## Specifications

CONTACT RATING: 0.2 AMP @ 30 V DC max.  
 ELECTRICAL LIFE: 10,000 make-and-break cycles at full load.  
 MECHANICAL LIFE: 10,000 on/off cycles.  
 CONTACT RESISTANCE: 30 mΩ max. initial  
 INSULATION RESISTANCE: 100 MΩ min.  
 DIELECTRIC STRENGTH: 500 V AC min.  
 OPERATING/STORAGE TEMPERATURES: -10°C to 60°C.  
 PACKAGING: Switches are supplied in anti-static trays.

## Materials

FRAME: Tin plated steel.  
 ACTUATOR: PA 66 black.  
 BASE: Phenolic resin.  
 TERMINALS: Silver plated brass.  
 MOVABLE CONTACTS: Silver plated phosphor bronze.  
 RETURN SPRING: SWC  
 DETENT SPRING: Phosphor bronze.  
 DETENT SPRING PLATE: Phosphor bronze.  
 RETURN SPRING RETAINER RING: Nickel plated steel.  
 TERMINAL SEAL: Epoxy.

## Build-A-Switch

To order, simply select desired option from each category and place in the appropriate box. For additional options not shown in catalog, consult Customer Service Center.

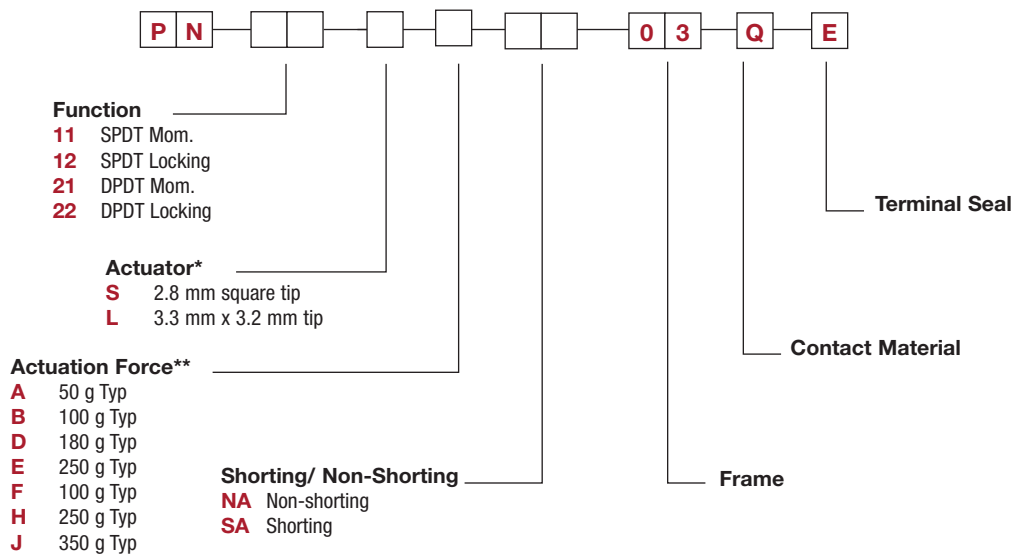

\* Note - The switch body style dimensions differ for each of these 3 groupings

“S” actuator available for PN 11 & PN 12 options

“S” actuator available for PN 21 & PN 22 options

“L” actuator available for PN 21 & PN 22 options

\*\* Actuation Force “A” only available with PN11 with “S” actuator

PN 11 & PN 21 available with Actuation Force “B”, “D”, “E”, “F”, “H”, “J”

PN 12 & PN 22 available with Actuation Force “D”, “E”, “H”, “J”

Full travel



# PN Series Alternate & Momentary Action Pushbutton Switches

Pushbutton

**PN 11** SPDT Mom.  
**PN 12** SPDT Locking

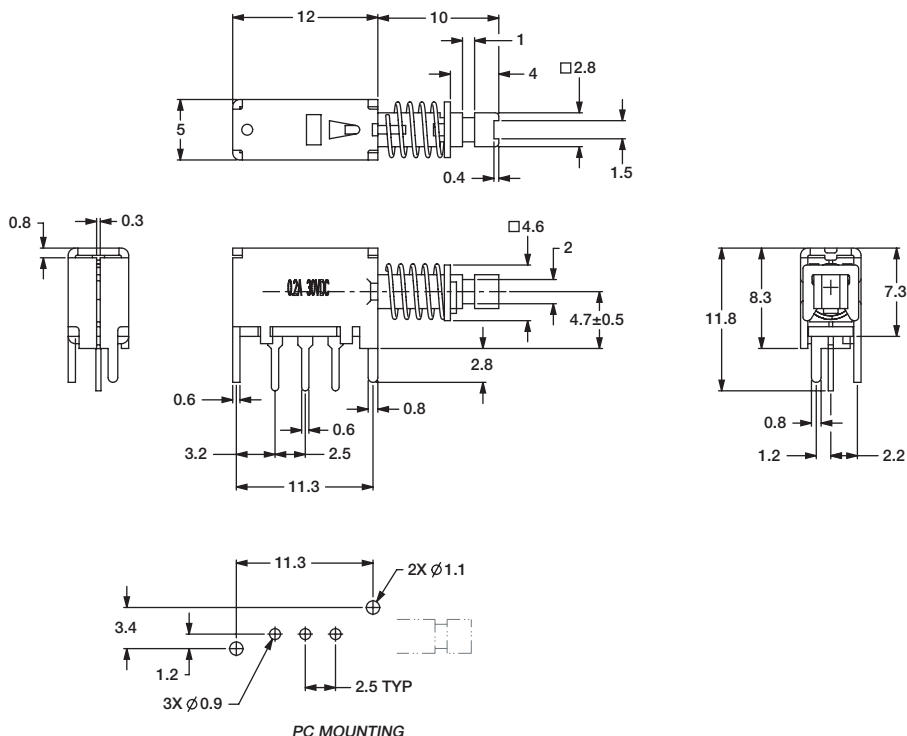

**PN 21** DPDT Mom. with "S" Actuator  
**PN 22** DPDT Locking with "S" Actuator

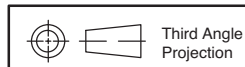
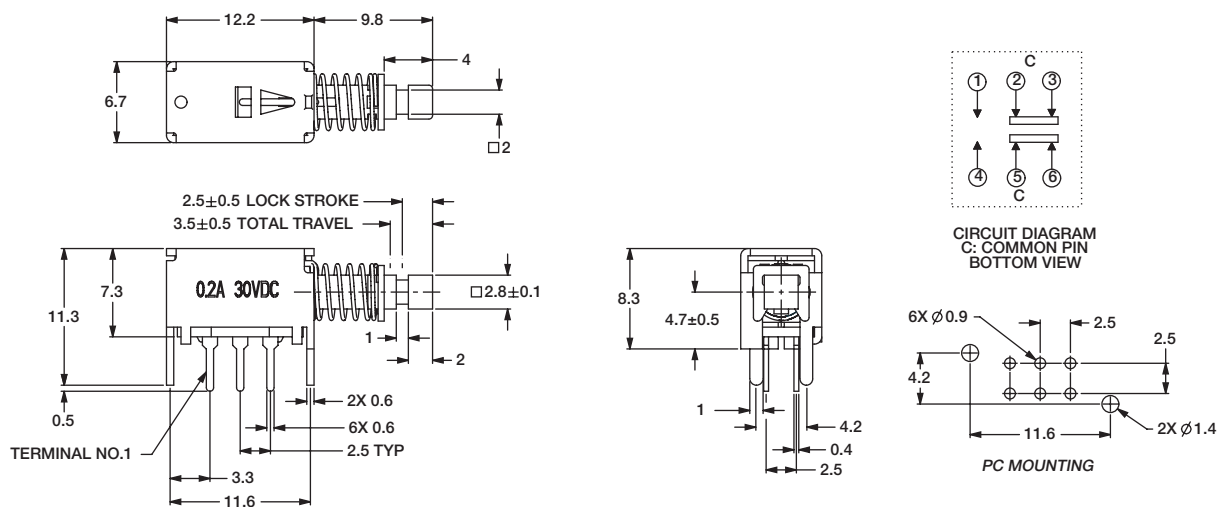

Third Angle  
Projection

Dimensions are shown: mm  
Specifications and dimensions subject to change



# PN Series Alternate & Momentary Action Pushbutton Switches



A  
Pushbutton

**PN 21** DPDT Mom. with "L" Actuator  
**PN 22** DPDT Locking with "L" Actuator

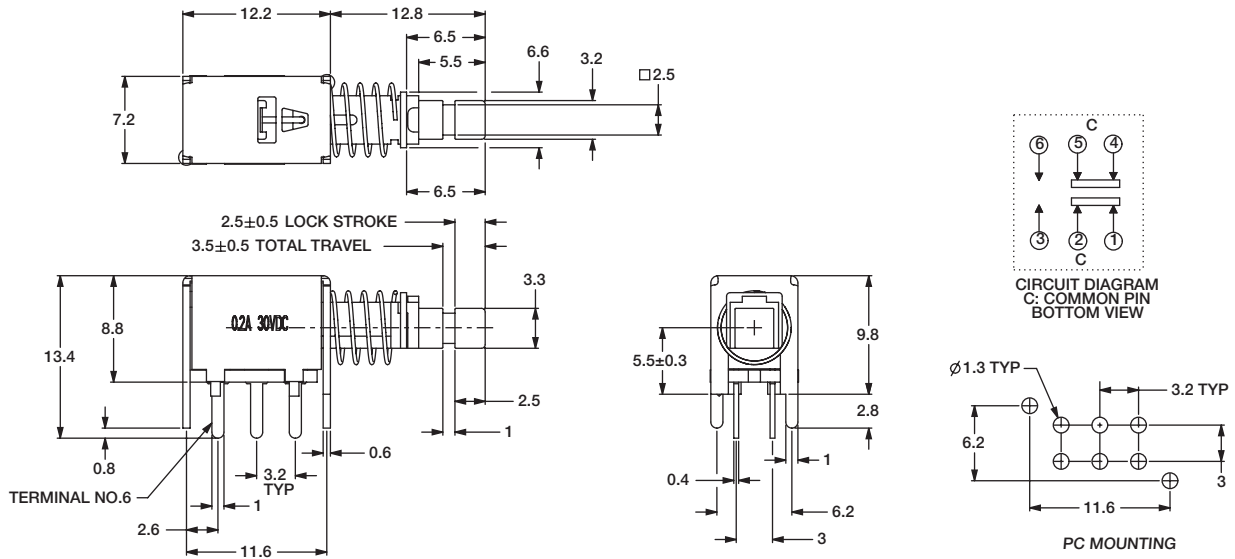

**BUTTONS MUST BE ORDERED SEPARATELY. SHIPPED IN BULK.**

## PE

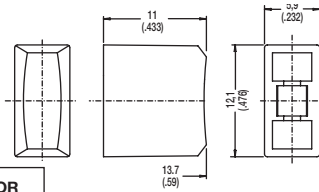
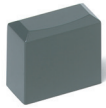

## PV

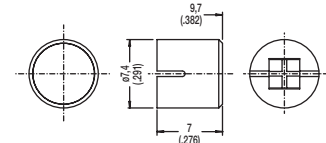

OPTION CODE	COLOR
<b>RD</b>	Red
<b>GY</b>	Gray
<b>BK</b>	Black
<b>WH</b>	White

PE and PV buttons fit "L" actuators

## Indexed

- G001A** Black
- G001G** Gray
- G001I** Ivory
- G001R** Red

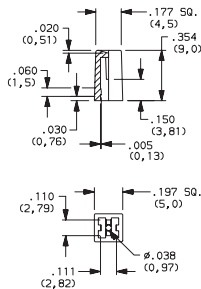
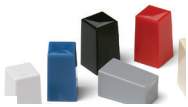

## Rectangular

- G002A** Black
- G002G** Gray
- G002I** Ivory
- G002R** Red

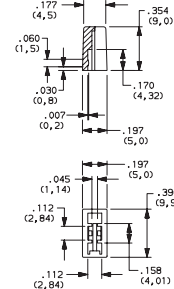

## Round

- G003A** Black
- G003G** Gray
- G003I** Ivory
- G003R** Red

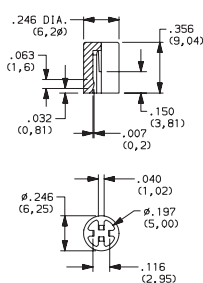

## Square

- G004A** Black
- G004G** Gray
- G004I** Ivory
- G004R** Red

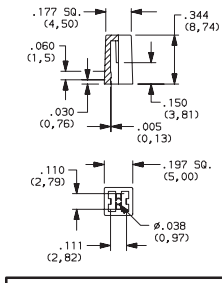
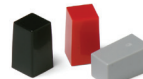

G001, G002, G003 and G004 buttons fit "S" actuators

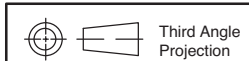

Dimensions are shown: Inches (mm)  
 Specifications and dimensions subject to change

# Mouser Electronics

Authorized Distributor

Click to View Pricing, Inventory, Delivery & Lifecycle Information:

## C&K Switches:

[G003A](#) [G003R](#) [G001A](#) [G001G](#) [G001R](#) [G002A](#) [G002G](#) [G002R](#) [G003G](#) [G004A](#) [G004G](#)