



DATA SHEET

BIPOLAR ANALOG INTEGRATED CIRCUIT μ PC8172TB

SILICON MMIC 2.5 GHz FREQUENCY UP-CONVERTER FOR WIRELESS TRANSCEIVER

DESCRIPTION

The μ PC8172TB is a silicon monolithic integrated circuit designed as frequency up-converter for wireless transceiver transmitter stage.

This IC is as same circuit current as conventional μ PC8106TB, but operates at higher frequency, higher gain and lower distortion. Consequently this IC is suitable for mobile communications.

FEATURES

- Recommended operating frequency : $f_{RFout} = 0.8$ to 2.5 GHz
- Higher IP_3 : $CG = 9.5$ dB TYP., $OIP_3 = +7.5$ dBm TYP. @ $f_{RFout} = 0.9$ GHz
- High-density surface mounting : 6-pin super minimold package
- Supply voltage : $V_{CC} = 2.7$ to 3.3 V

APPLICATIONS

- PCS1900M
- 2.4 GHz band transmitter/receiver system (wireless LAN etc.)

ORDERING INFORMATION

Part Number	Package	Marking	Supplying Form
μ PC8172TB-E3	6-pin super minimold	C3A	<ul style="list-style-type: none">• Embossed tape 8 mm wide.• Pin 1, 2, 3 face the tape perforation side.• Qty 3 kpcs/reel.

Remark To order evaluation samples, please contact your nearby sales office.
(Part number for sample order: μ PC8172TB-A)

Caution Electro-static sensitive devices

PIN CONNECTIONS

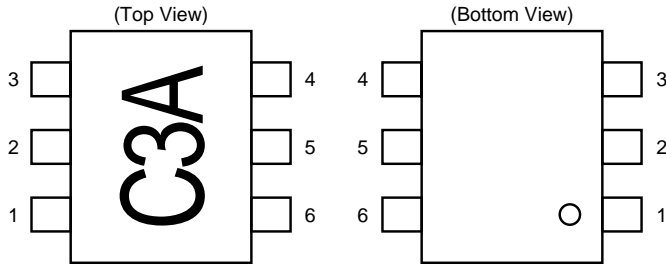

Pin No.	Pin Name
1	IFinput
2	GND
3	LOinput
4	PS
5	V _{cc}
6	RFoutput

SERIES PRODUCTS (T_A = +25°C, V_{CC} = V_{RFout} = 3.0 V, Z_s = Z_L = 50 Ω)

Part Number	I _{cc} (mA)	f _{RFout} (GHz)	CG (dB)		
			@RF 0.9 GHz ^{Note}	@RF 1.9 GHz	@RF 2.4 GHz
μ PC8172TB	9	0.8 to 2.5	9.5	8.5	8.0
μ PC8106TB	9	0.4 to 2.0	9	7	–
μ PC8109TB	5	0.4 to 2.0	6	4	–
μ PC8163TB	16.5	0.8 to 2.0	9	5.5	–

Part Number	P _{O(sat)} (dBm)			OIP ₃ (dBm)		
	@RF 0.9 GHz ^{Note}	@RF 1.9 GHz	@RF 2.4 GHz	@RF 0.9 GHz ^{Note}	@RF 1.9 GHz	@RF 2.4 GHz
μ PC8172TB	+0.5	0	–0.5	+7.5	+6.0	+4.0
μ PC8106TB	–2	–4	–	+5.5	+2.0	–
μ PC8109TB	–5.5	–7.5	–	+1.5	–1.0	–
μ PC8163TB	+0.5	–2	–	+9.5	+6.0	–

Note f_{RFout} = 0.83 GHz @ μ PC8163TB

Remark Typical performance. Please refer to **ELECTRICAL CHARACTERISTICS** in detail.
To know the associated product, please refer to each latest data sheet.

BLOCK DIAGRAM (FOR THE μ PC8172TB)

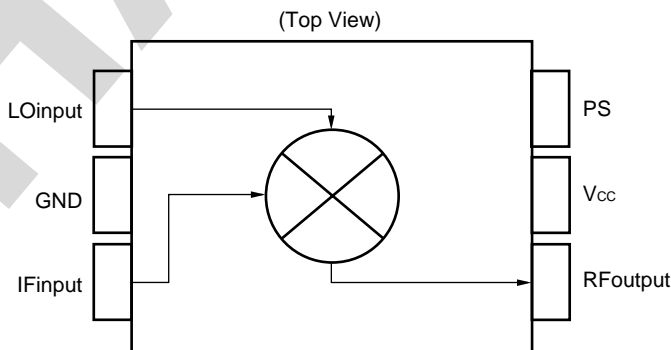

SYSTEM APPLICATION EXAMPLES (SCHEMATICS OF IC LOCATION IN THE SYSTEM)

Wireless Transceiver

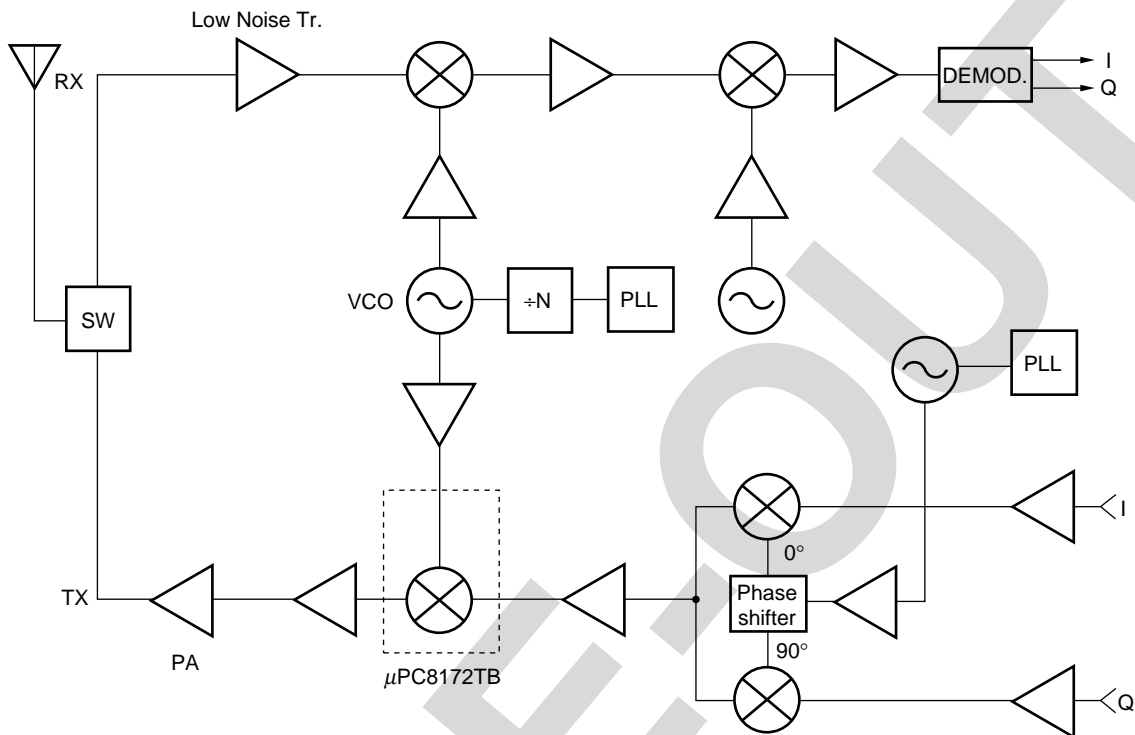

To know the associated products, please refer to each latest data sheet.

CONTENTS

1. PIN EXPLANATION.....	5
2. ABSOLUTE MAXIMUM RATINGS.....	6
3. RECOMMENDED OPERATING CONDITIONS.....	6
4. ELECTRICAL CHARACTERISTICS	6
5. OTHER CHARACTERISTICS, FOR REFERENCE PURPOSES ONLY.....	7
6. TEST CIRCUIT.....	8
6.1 TEST CIRCUIT 1 (f_{RFout} = 900 MHz).....	8
6.2 TEST CIRCUIT 2 (f_{RFout} = 1.9 GHz).....	9
6.3 TEST CIRCUIT 3 (f_{RFout} = 2.4 GHz).....	10
7. TYPICAL CHARACTERISTICS.....	12
8. PACKAGE DIMENSIONS.....	24
9. NOTE ON CORRECT USE.....	25
10. RECOMMENDED SOLDERING CONDITIONS.....	25

PHASEROUT

1. PIN EXPLANATION

Pin No.	Pin Name	Applied Voltage (V)	Pin Voltage (V) ^{Note}	Function and Explanation	Equivalent Circuit						
1	IFinput	–	1.4	This pin is IF input to double balanced mixer (DBM). The input is designed as high impedance. The circuit contributes to suppress spurious signal. Also this symmetrical circuit can keep specified performance insensitive to process-condition distribution. For above reason, double balanced mixer is adopted.							
2	GND	GND	–	GND pin. Ground pattern on the board should be formed as wide as possible. Track Length should be kept as short as possible to minimize ground impedance.							
3	LOinput	–	2.3	Local input pin. Recommendable input level is –10 to 0 dBm.							
5	Vcc	2.7 to 3.3	–	Supply voltage pin.							
6	RFoutput	Same bias as Vcc through external inductor	–	This pin is RF output from DBM. This pin is designed as open collector. Due to the high impedance output, this pin should be externally equipped with LC matching circuit to next stage.							
4	PS	Vcc/GND	–	Power save control pin. Bias controls operation as follows. <table border="1" style="margin: 10px auto;"> <thead> <tr> <th>Pin bias</th> <th>Control</th> </tr> </thead> <tbody> <tr> <td>Vcc</td> <td>Operation</td> </tr> <tr> <td>GND</td> <td>Power Save</td> </tr> </tbody> </table>	Pin bias	Control	Vcc	Operation	GND	Power Save	
Pin bias	Control										
Vcc	Operation										
GND	Power Save										

Note Each pin voltage is measured with Vcc = VPS = VRFout = 3.0 V.

★ 2. ABSOLUTE MAXIMUM RATINGS

Parameter	Symbol	Test Conditions	Rating	Unit
Supply Voltage	V_{CC}	$T_A = +25^{\circ}C$	3.6	V
PS pin Input Voltage	V_{PS}	$T_A = +25^{\circ}C$	3.6	V
Power Dissipation of Package	P_D	Mounted on double-side copperclad $50 \times 50 \times 1.6$ mm epoxy glass PWB ($T_A = +85^{\circ}C$)	270	mW
Operating Ambient Temperature	T_A		-40 to +85	$^{\circ}C$
Storage Temperature	T_{stg}		-55 to +150	$^{\circ}C$
Input Power	P_{in}		+10	dBm

3. RECOMMENDED OPERATING CONDITIONS

Parameter	Symbol	Test Conditions	MIN.	TYP.	MAX.	Unit
Supply Voltage	V_{CC}	The same voltage should be applied to pin 5 and 6	2.7	3.0	3.3	V
Operating Ambient Temperature	T_A		-40	+25	+85	$^{\circ}C$
Local Input Level	P_{LOin}	$Z_s = 50 \Omega$ (without matching)	-10	-5	0	dBm
RF Output Frequency	f_{RFout}	With external matching circuit	0.8	-	2.5	GHz
IF Input Frequency	f_{IFin}		50	-	400	MHz

4. ELECTRICAL CHARACTERISTICS

($T_A = +25^{\circ}C$, $V_{CC} = V_{RFout} = 3.0$ V, $f_{IFin} = 240$ MHz, $P_{LOin} = -5$ dBm, and $V_{PS} \geq 2.7$ V unless otherwise specified)

Parameter	Symbol	Test Conditions ^{Note}	MIN.	TYP.	MAX.	Unit
Circuit Current	I_{CC}	No Signal	5.5	9.0	13	mA
Circuit Current In Power Save Mode	$I_{CC(PS)}$	$V_{PS} = 0$ V	-	-	2	μA
Conversion Gain	CG1	$f_{RFout} = 0.9$ GHz, $P_{IFin} = -30$ dBm	6.5	9.5	12.5	dB
	CG2	$f_{RFout} = 1.9$ GHz, $P_{IFin} = -30$ dBm	5.5	8.5	11.5	dB
	CG3	$f_{RFout} = 2.4$ GHz, $P_{IFin} = -30$ dBm	5	8.0	11.0	dB
Saturated RF Output Power	$P_{O(sat)1}$	$f_{RFout} = 0.9$ GHz, $P_{IFin} = 0$ dBm	-2.5	+0.5	-	dBm
	$P_{O(sat)2}$	$f_{RFout} = 1.9$ GHz, $P_{IFin} = 0$ dBm	-3.5	0	-	dBm
	$P_{O(sat)3}$	$f_{RFout} = 2.4$ GHz, $P_{IFin} = 0$ dBm	-4	-0.5	-	dBm

Note $f_{RFout} < f_{LOin}$ @ $f_{RFout} = 0.9$ GHz
 $f_{LOin} < f_{RFout}$ @ $f_{RFout} = 1.9$ GHz/2.4 GHz

5. OTHER CHARACTERISTICS, FOR REFERENCE PURPOSES ONLY

(TA = +25°C, VCC = VRFout = 3.0 V, PLOin = -5 dBm, and VPS ≥ 2.7 V unless otherwise specified)

Parameter		Symbol	Test Conditions ^{Note}	Data	Unit
Output Third-Order Distortion Intercept Point		OIP ₃₁	f _{RFout} = 0.9 GHz	+7.5	dBm
		OIP ₃₂	f _{RFout} = 1.9 GHz		
		OIP ₃₃	f _{RFout} = 2.4 GHz		
Input Third-Order Distortion Intercept Point		IIP ₃₁	f _{RFout} = 0.9 GHz	-2.0	dBm
		IIP ₃₂	f _{RFout} = 1.9 GHz		
		IIP ₃₃	f _{RFout} = 2.4 GHz		
SSB Noise Figure		SSB•NF1	f _{RFout} = 0.9 GHz, f _{fIn} = 240 MHz	9.5	dB
		SSB•NF2	f _{RFout} = 1.9 GHz, f _{fIn} = 240 MHz	10.4	dB
		SSB•NF3	f _{RFout} = 2.4 GHz, f _{fIn} = 240 MHz	10.6	dB
Power Save Response Time	Rise time	T _{PS(rise)}	V _{PS} : GND → V _{CC}	1	μs
	Fall time	T _{PS(fall)}	V _{PS} : V _{CC} → GND	1.5	μs

Note f_{RFout} < f_{LOin} @ f_{RFout} = 0.9 GHzf_{LOin} < f_{RFout} @ f_{RFout} = 1.9 GHz/2.4 GHz

6. TEST CIRCUIT

★ 6.1 TEST CIRCUIT 1 ($f_{RFout} = 900\text{ MHz}$)

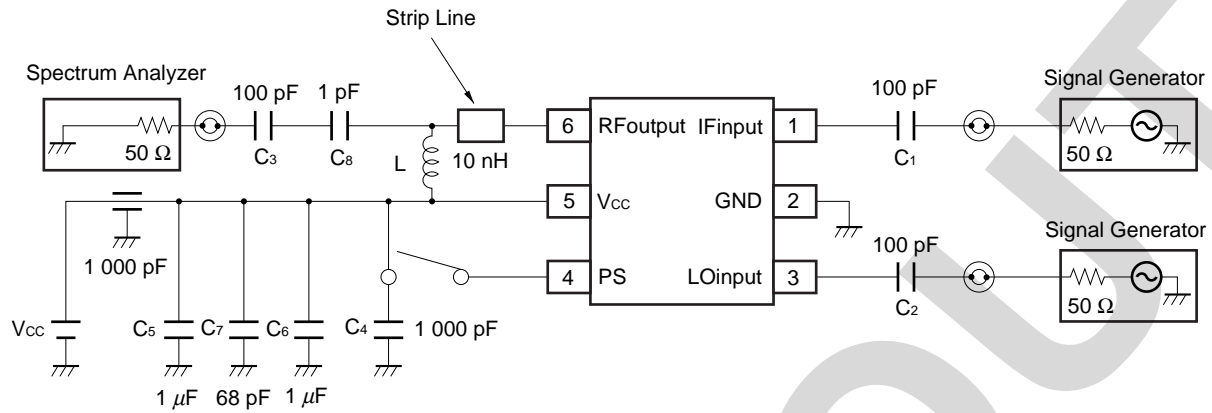

EXAMPLE OF TEST CIRCUIT 1 ASSEMBLED ON EVALUATION BOARD

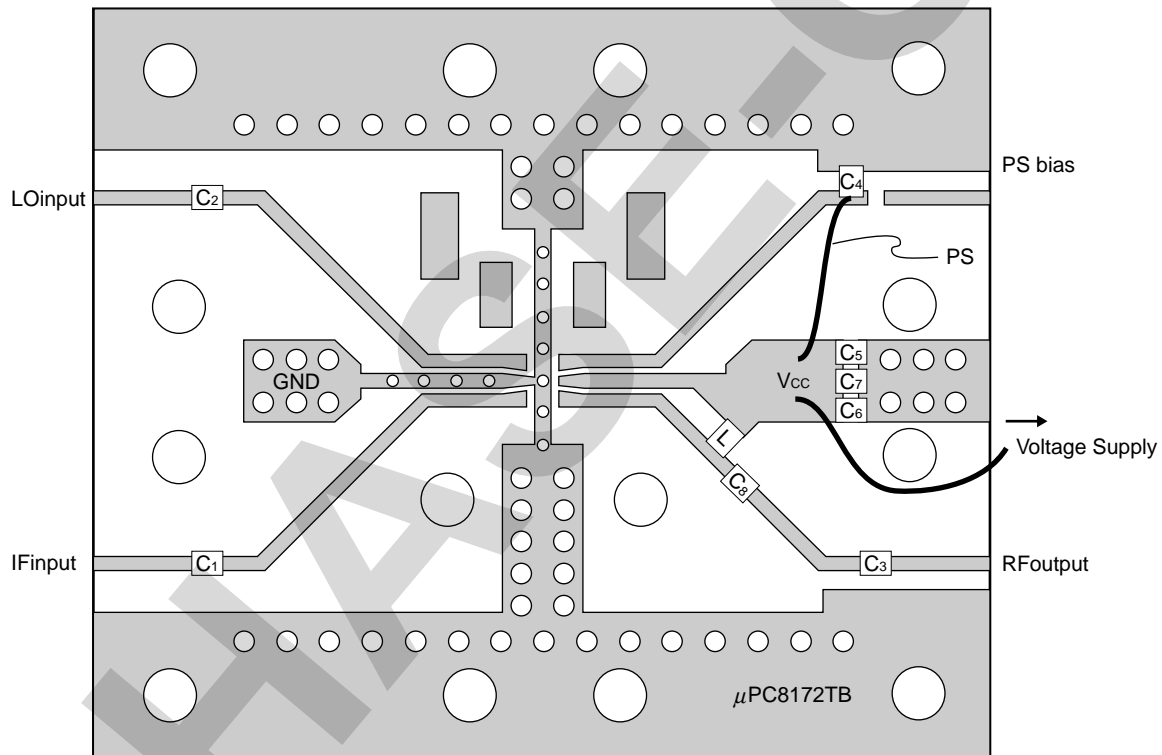

COMPONENT LIST

Form	Symbol	Value
Chip capacitor	C ₁ , C ₂ , C ₃	100 pF
	C ₄	1 000 pF
	C ₅ , C ₆	1 μF
	C ₇	68 pF
	C ₈	1 pF
Chip inductor	L	10 nH ^{Note}

- (*1) 35 × 42 × 0.4 mm polyimide board, double-sided copper clad
- (*2) Ground pattern on rear of the board
- (*3) Solder plated patterns
- (*4) ○○: Through holes

Note 10 nH: LL1608-FH10N (TOKO Co., Ltd.)

★ 6.2 TEST CIRCUIT 2 ($f_{RFout} = 1.9\text{ GHz}$)

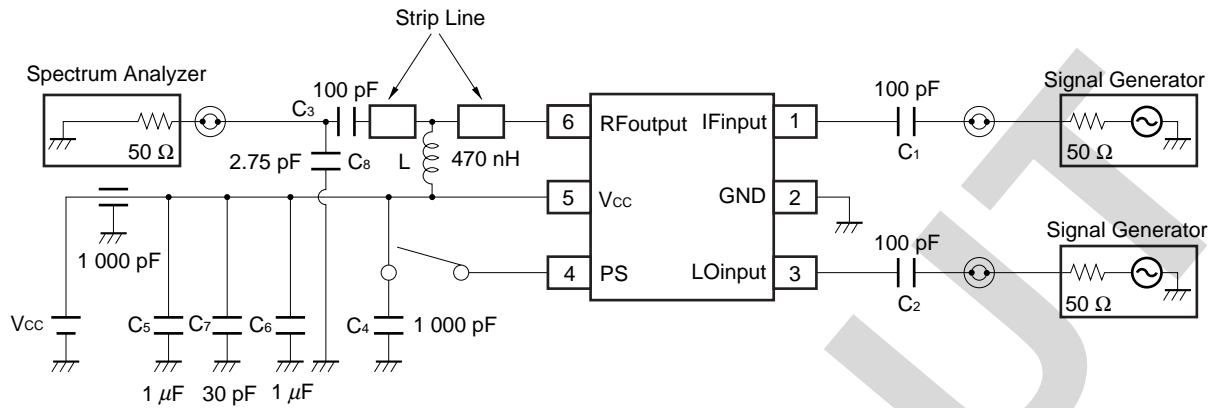

EXAMPLE OF TEST CIRCUIT 2 ASSEMBLED ON EVALUATION BOARD

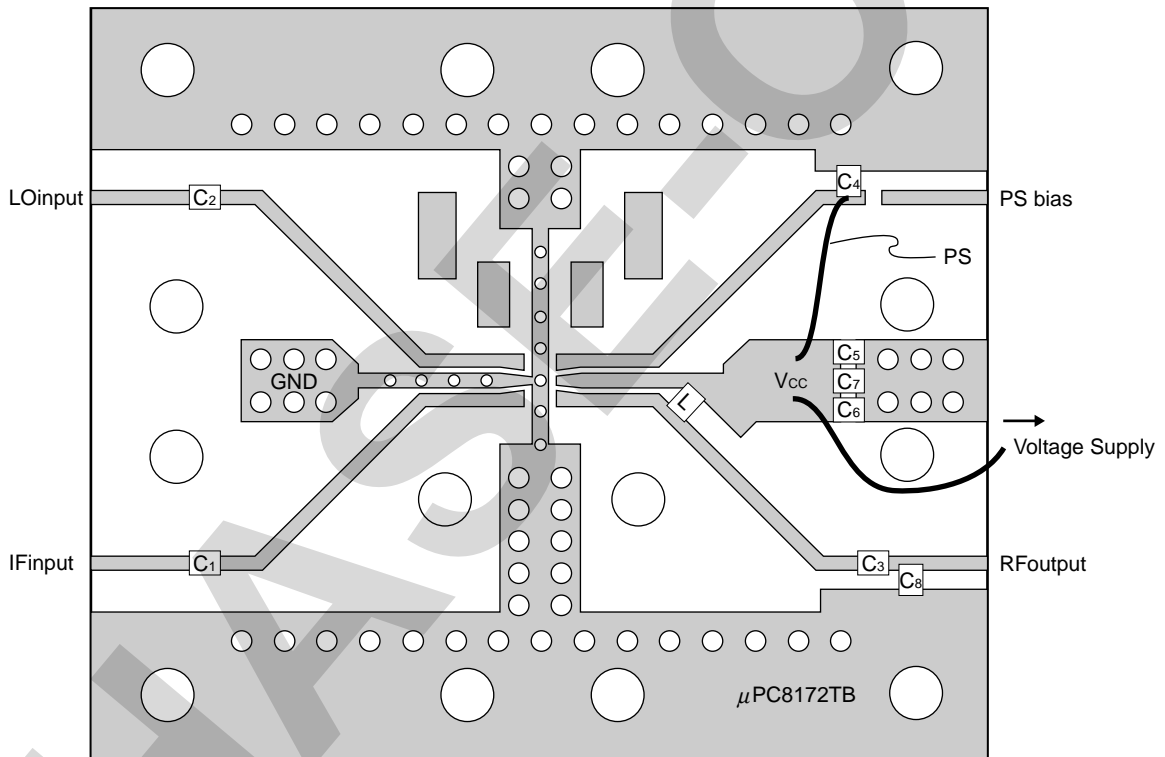

COMPONENT LIST

Form	Symbol	Value
Chip capacitor	C ₁ , C ₂ , C ₃	100 pF
	C ₄	1 000 pF
	C ₅ , C ₆	1 μF
	C ₇	30 pF
	C ₈	2.75 pF
Chip inductor	L	470 nH ^{Note}

- (*1) 35 × 42 × 0.4 mm polyimide board, double-sided copper clad
- (*2) Ground pattern on rear of the board
- (*3) Solder plated patterns
- (*4) ○ ○ ○: Through holes

Note 470 nH: LL2012-FR47 (TOKO Co., Ltd.)

★ 6.3 TEST CIRCUIT 3 (f_{RFout} = 2.4 GHz)

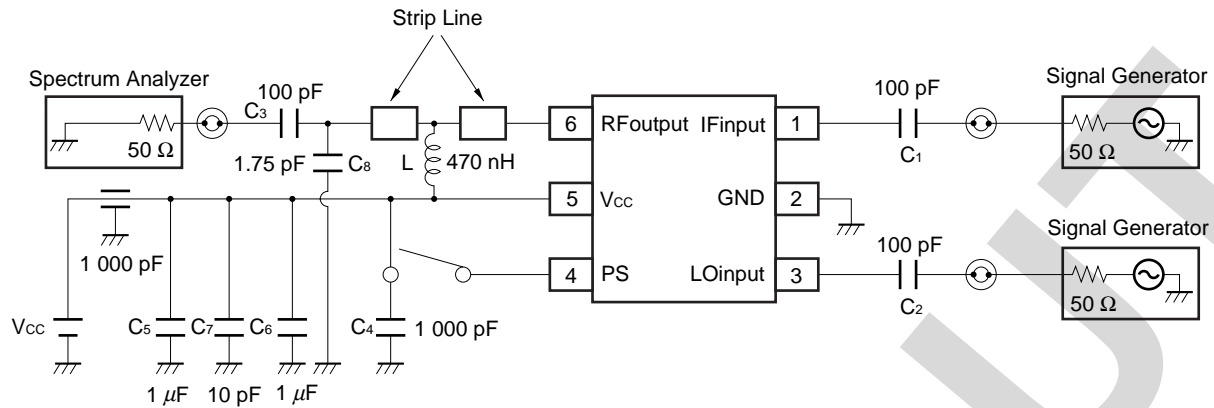

EXAMPLE OF TEST CIRCUIT 3 ASSEMBLED ON EVALUATION BOARD

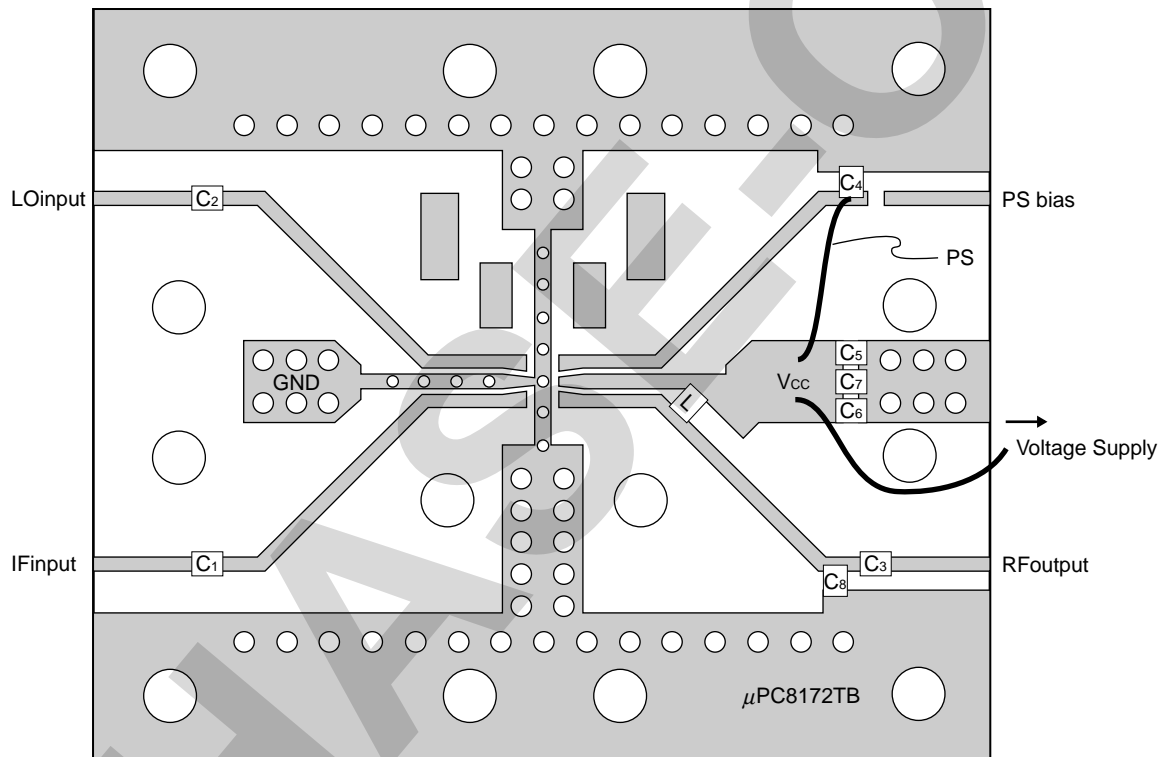

COMPONENT LIST

Form	Symbol	Value
Chip capacitor	C ₁ , C ₂ , C ₃	100 pF
	C ₄	1 000 pF
	C ₅ , C ₆	1 μF
	C ₇	10 pF
	C ₈	1.75 pF
	Chip inductor	L

- (*1) 35 × 42 × 0.4 mm polyimide board, double-sided copper clad
- (*2) Ground pattern on rear of the board
- (*3) Solder plated patterns
- (*4) ○○○: Through holes

Note 470 nH: LL2012-FR47 (TOKO Co., Ltd.)

Caution The test circuits and board pattern on data sheet are for performance evaluation use only (They are not recommended circuits). In the case of actual design-in, matching circuit should be determined using S-parameter of desired frequency in accordance to actual mounting pattern.

PHASE-OUT

★ 7. TYPICAL CHARACTERISTICS (Unless otherwise specified, $T_A = +25^\circ\text{C}$, $V_{CC} = V_{RFout}$)

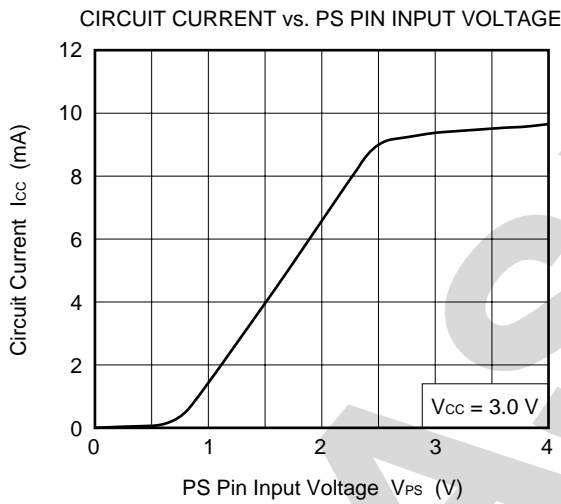
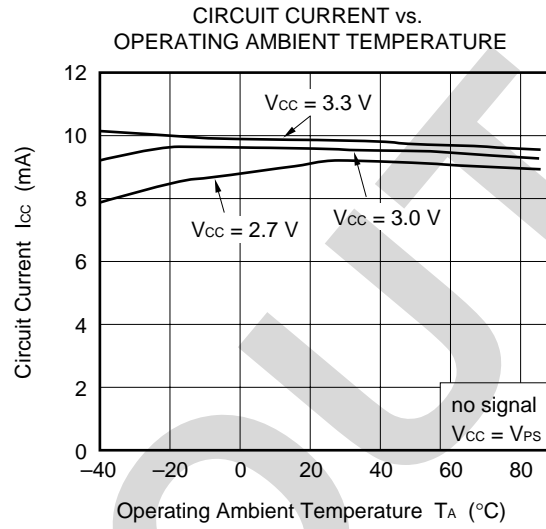
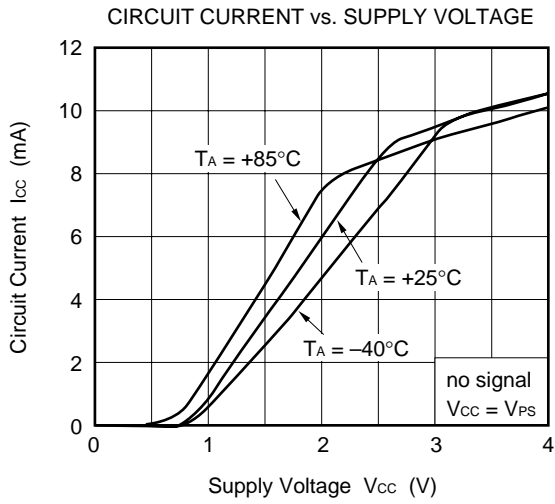

PS PIN CONTROL RESPONSE TIME

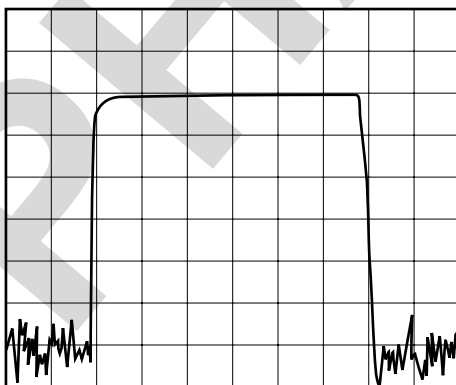

REF LVL = 0 dBm
 ATT = 10 dB
 10 dB/DIV (Vertical axis)
 CENTER = 0.9 GHz
 SPAN = 0 Hz
 RBW = 3 MHz
 VBW = 3 MHz
 SWP = 50 μ sec
 5 μ sec/DIV (Horizontal axis)

★ **S-PARAMETERS FOR EACH PORT** ($V_{CC} = V_{PS} = V_{RFout} = 3.0\text{ V}$)
 (The parameters are monitored at DUT pins)

LO port

S_{11} Z
 REF 1.0 Units
 1 200.0 mUnits/
 ∇ 21.625 Ω -91.148 Ω
 hp

MARKER 1
 1.15 GHz
 MARKER 2
 1.65 GHz
 MARKER 3
 2.15 GHz

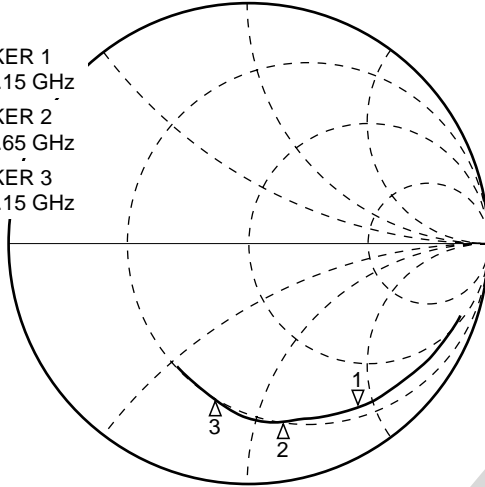

START 0.400000000 GHz
 STOP 2.500000000 GHz

RF port (without matching)

S_{22} Z
 REF 1.0 Units
 1 200.0 mUnits/
 ∇ 71.5 Ω -240.34 Ω
 hp

MARKER 1
 900.0 MHz
 MARKER 2
 1.9 GHz
 MARKER 3
 2.5 GHz

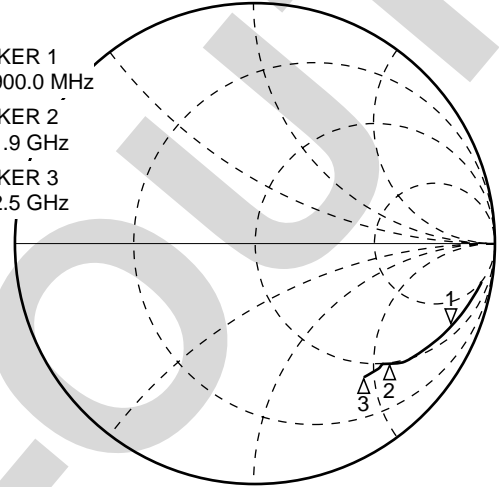

START 0.400000000 GHz
 STOP 2.500000000 GHz

IF port

S_{11} Z
 REF 1.0 Units
 1 200.0 mUnits/
 ∇ 332.63 Ω -601.34 Ω
 hp

MARKER 1
 240.0 MHz

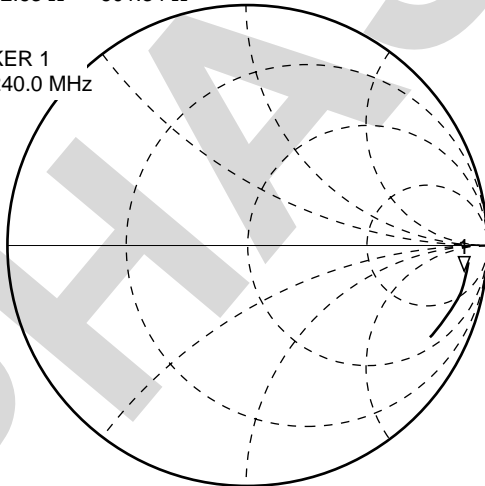

START 0.100000000 GHz
 STOP 1.000000000 GHz

★ **S-PARAMETERS FOR MATCHED RF OUTPUT** ($V_{CC} = V_{PS} = V_{RFout} = 3.0\text{ V}$) **—ON EVALUATION BOARD—**
(S₂₂ data are monitored at RF connector on board)

900 MHz (matched in test circuit 1)

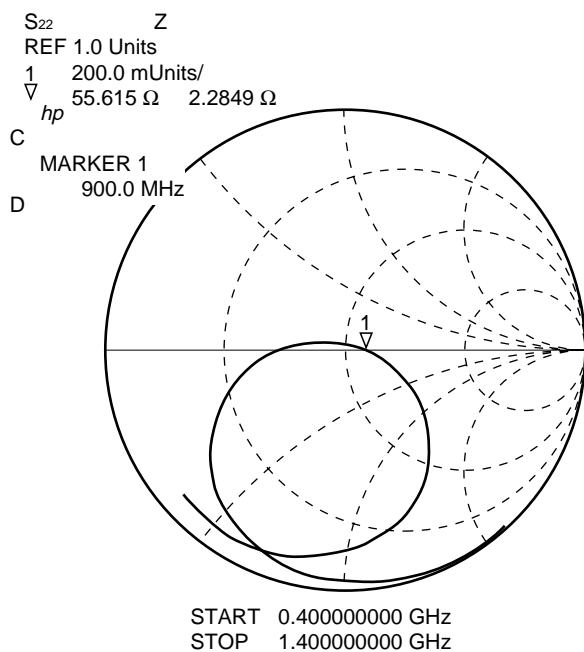

1.9 GHz (matched in test circuit 2)

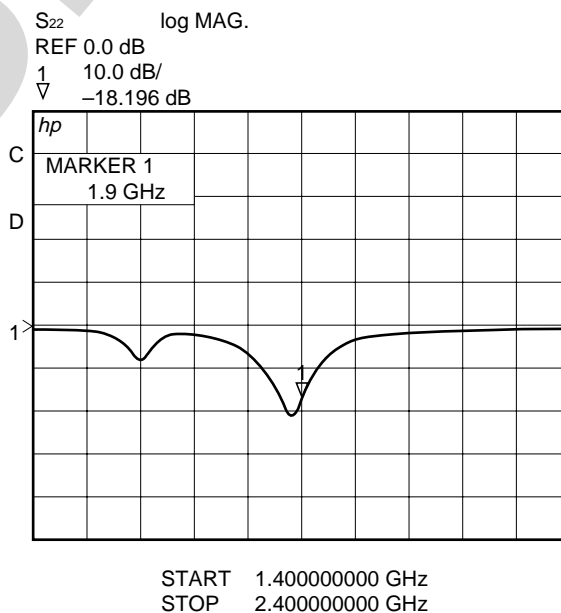
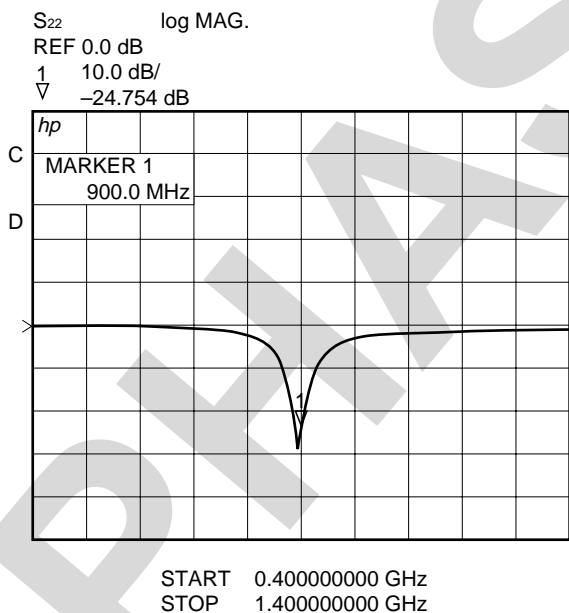
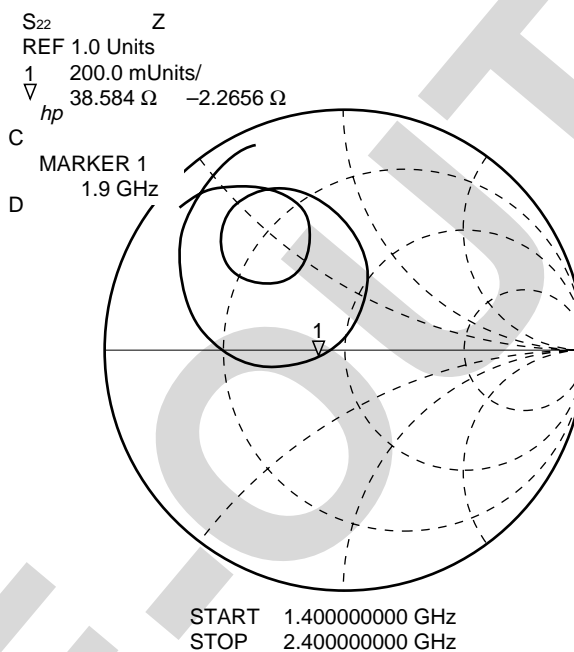

★ **S-PARAMETERS FOR MATCHED RF OUTPUT** ($V_{CC} = V_{PS} = V_{RFout} = 3.0\text{ V}$) **-ON EVALUATION BOARD-**
(S22 data are monitored at RF connector on board)

2.4 GHz (matched in test circuit 3)

S₂₂ Z
 REF 1.0 Units
 1 200.0 mUnits/
 ∇ 47.975 Ω -7.1113 Ω
 hp
 C MARKER 1
 D 2.4 GHz

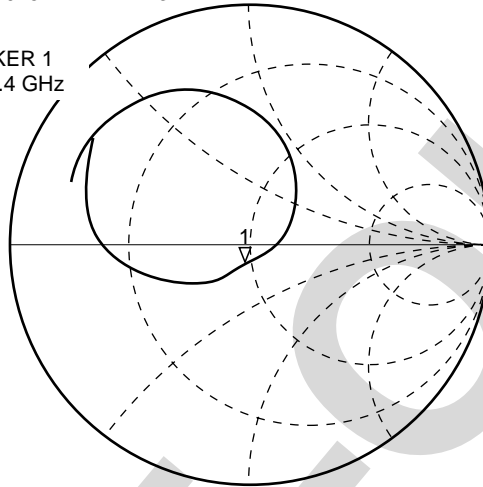

START 1.900000000 GHz
 STOP 2.900000000 GHz

S₂₂ log MAG.
 REF 0.0 dB
 1 10.0 dB/
 ∇ -22.326 dB

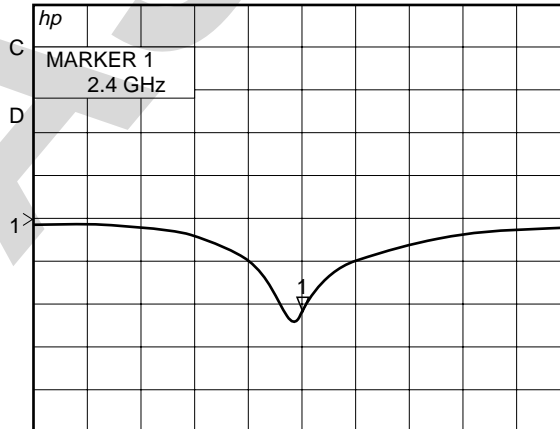

START 1.900000000 GHz
 STOP 2.900000000 GHz

CONVERSION GAIN vs. LOCAL INPUT LEVEL

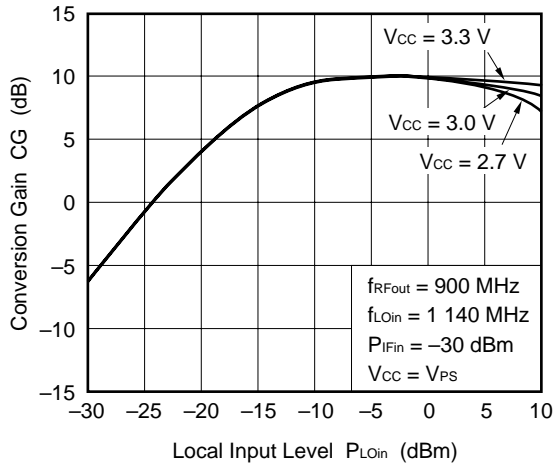

RF OUTPUT LEVEL vs. IF INPUT LEVEL

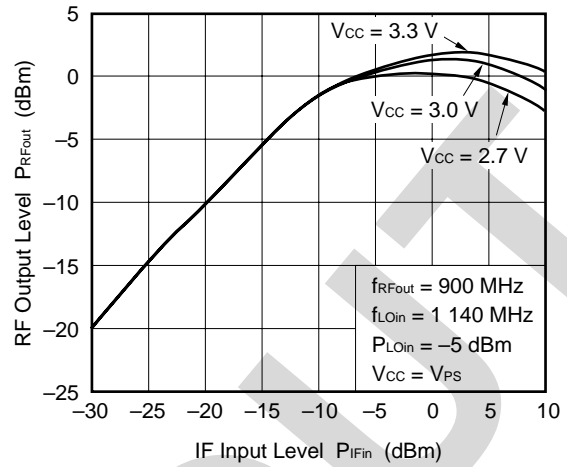

CONVERSION GAIN vs. LOCAL INPUT LEVEL

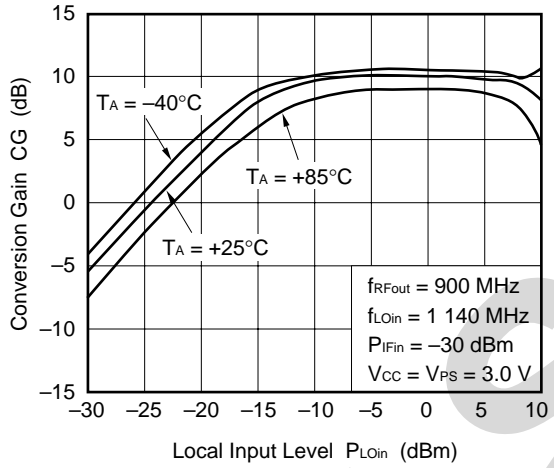

RF OUTPUT LEVEL vs. IF INPUT LEVEL

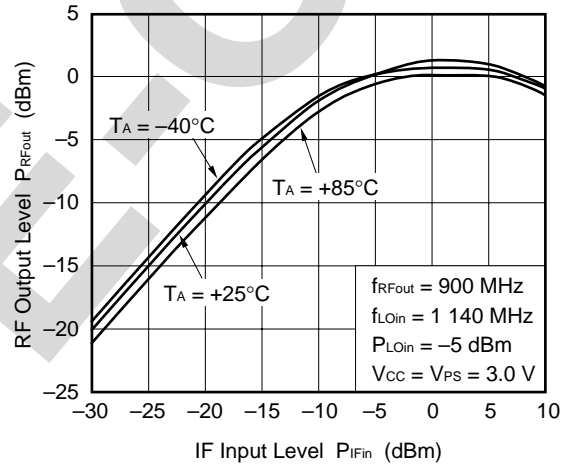

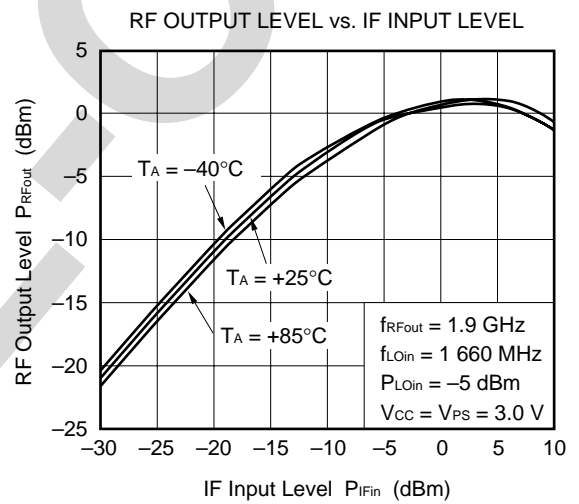
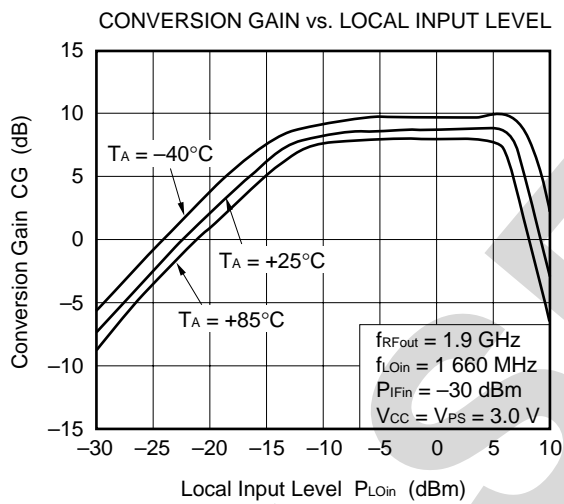
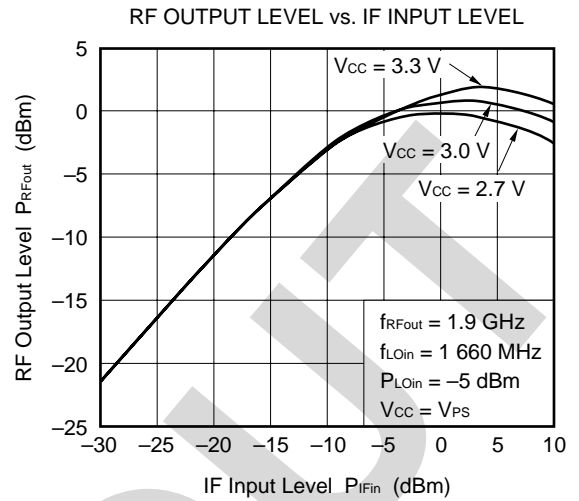
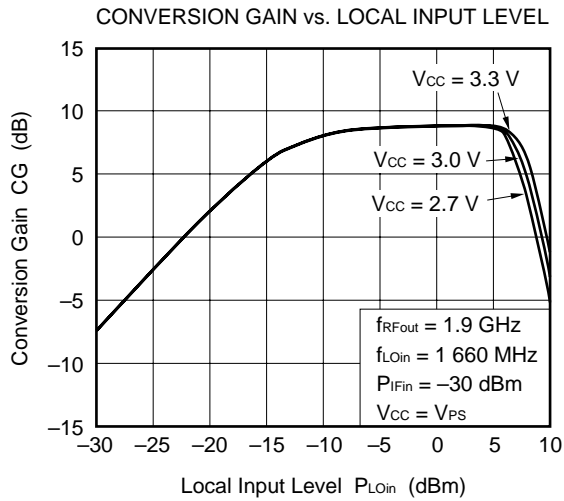

CONVERSION GAIN vs. LOCAL INPUT LEVEL

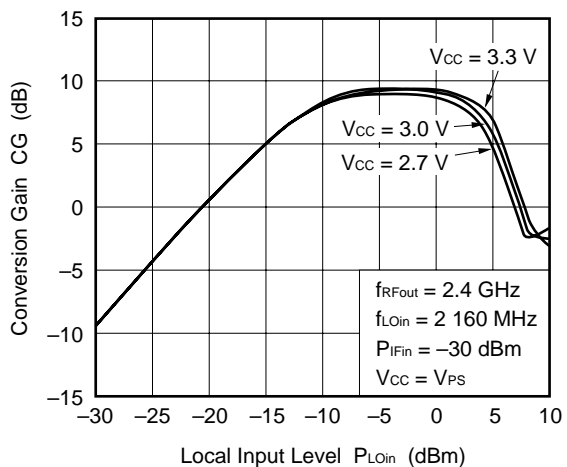

RF OUTPUT LEVEL vs. IF INPUT LEVEL

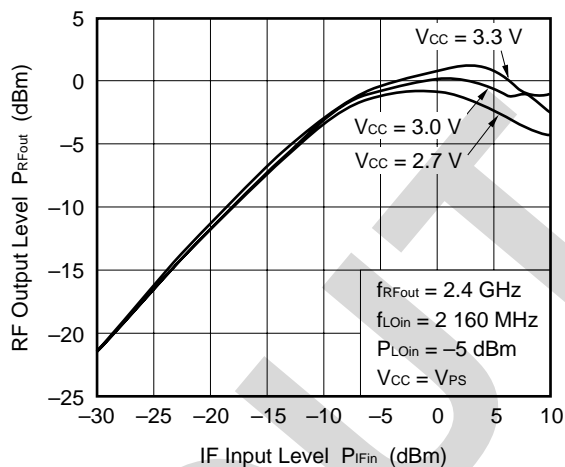

CONVERSION GAIN vs. LOCAL INPUT LEVEL

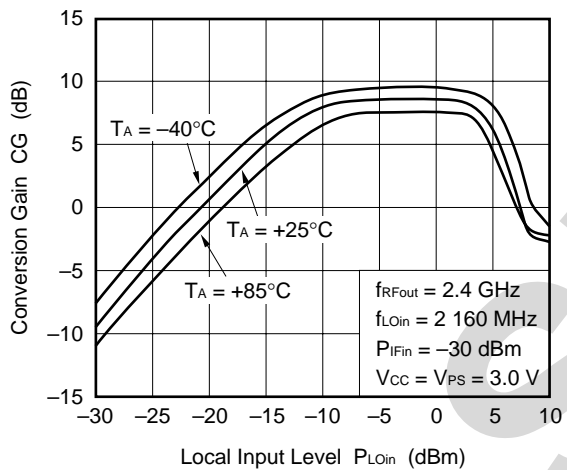

RF OUTPUT LEVEL vs. IF INPUT LEVEL

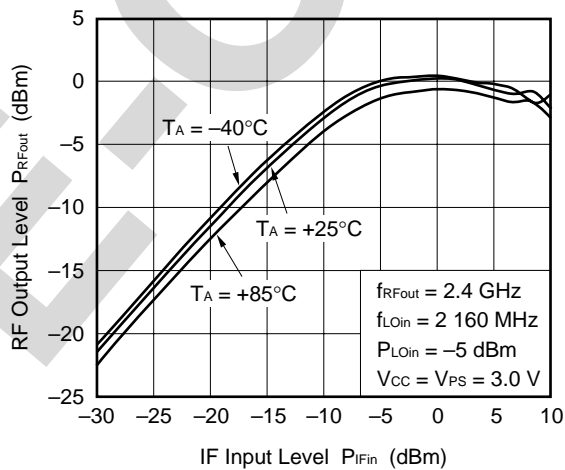

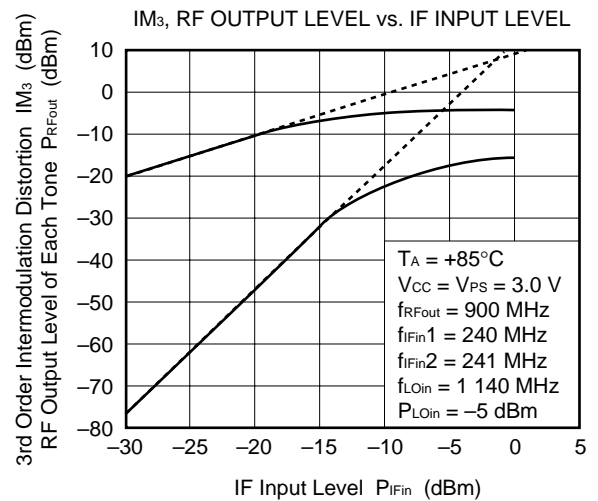
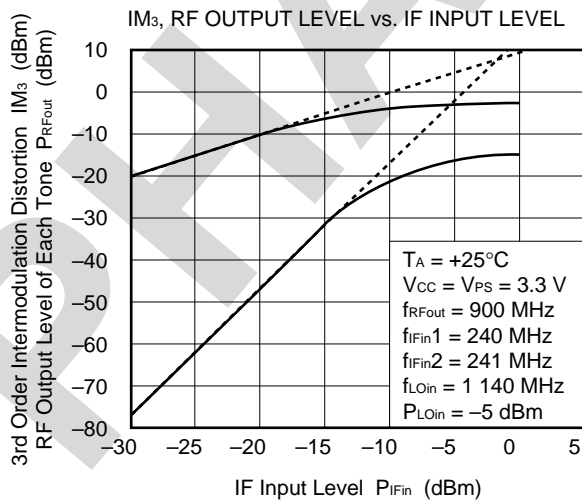
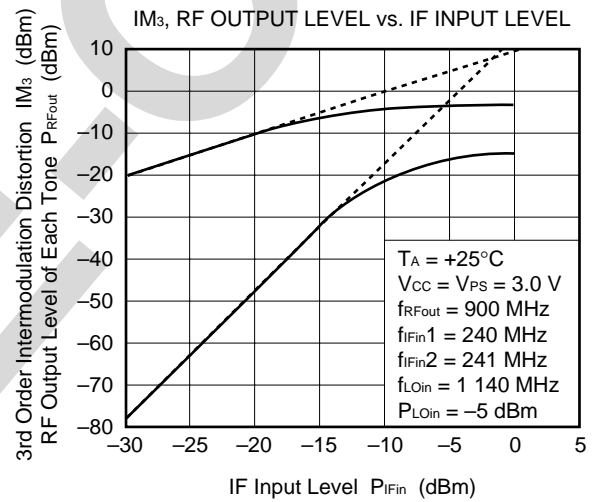
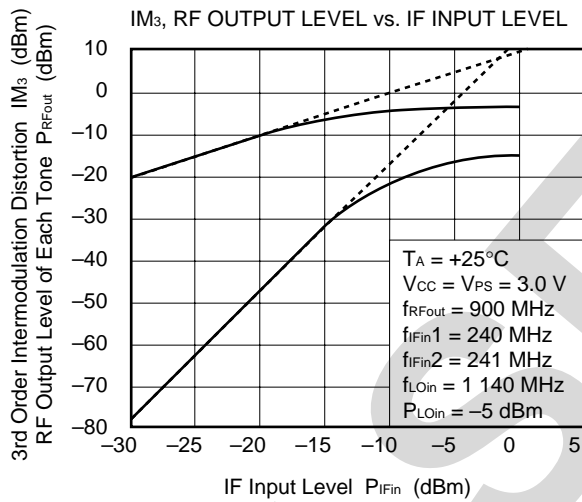
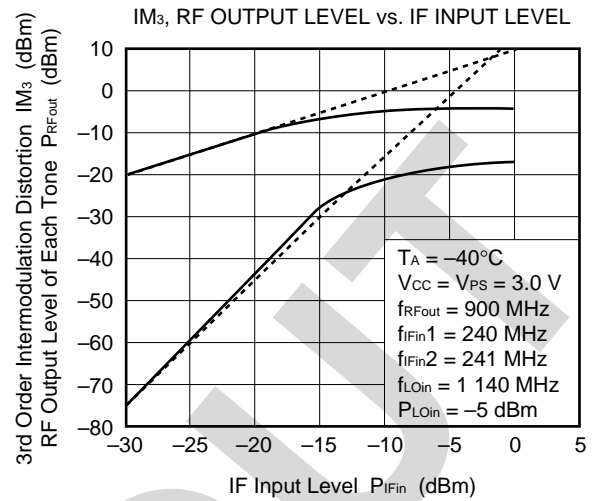
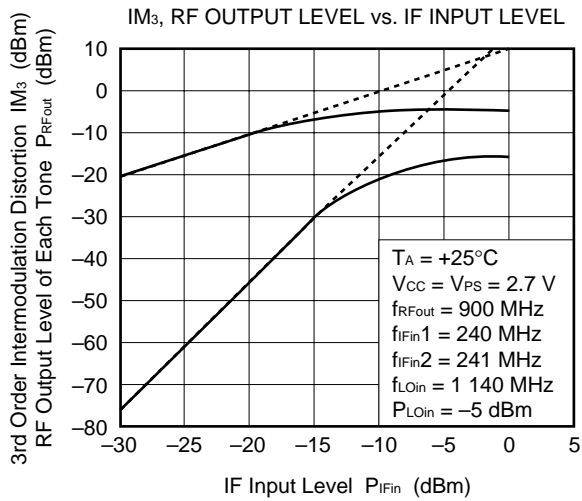

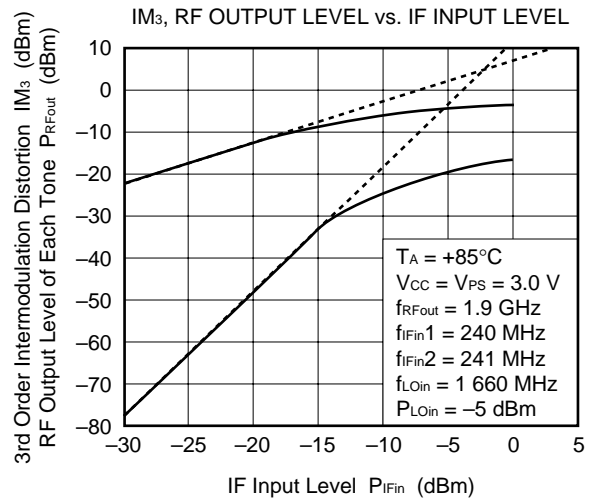
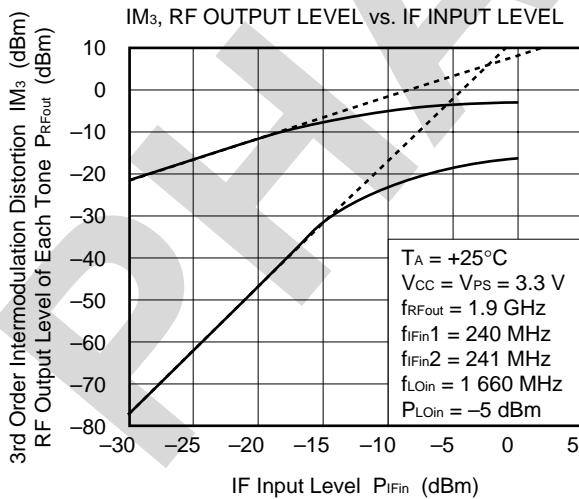
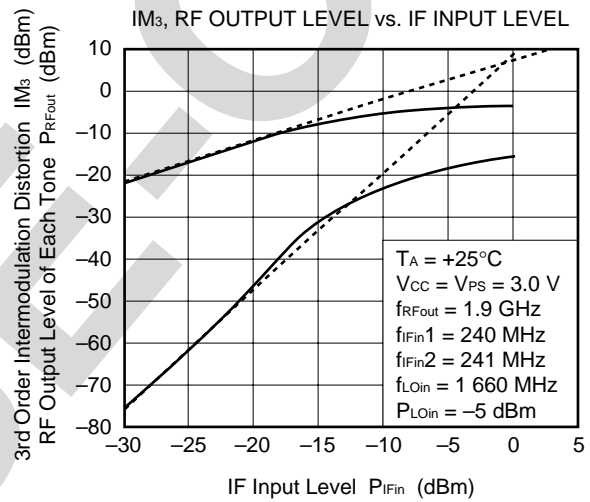
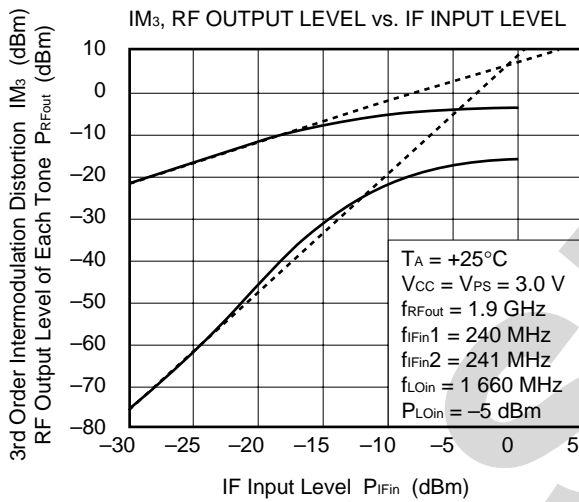
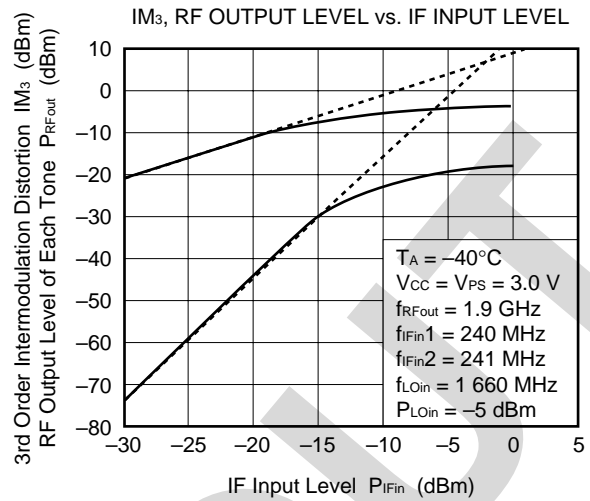
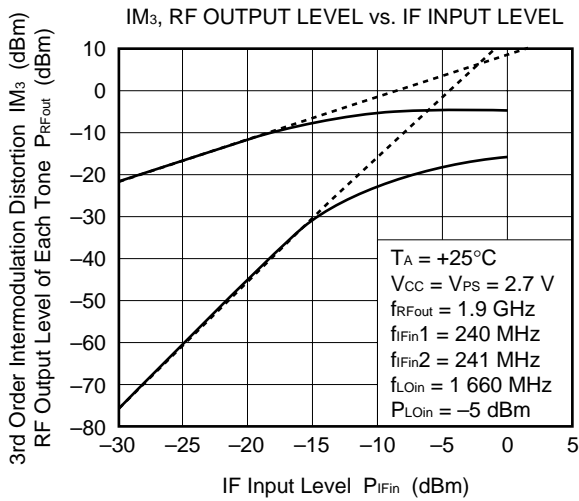

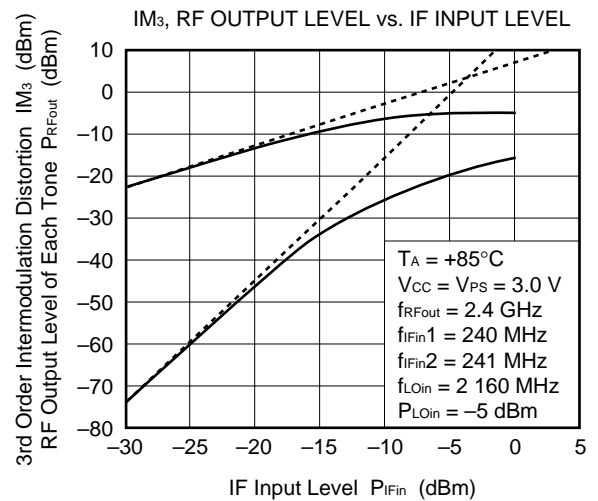
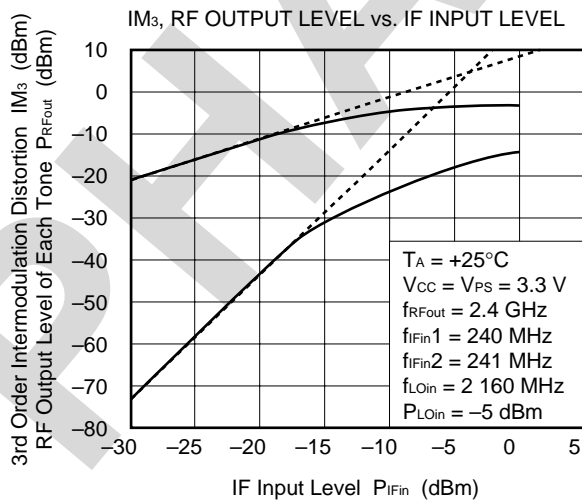
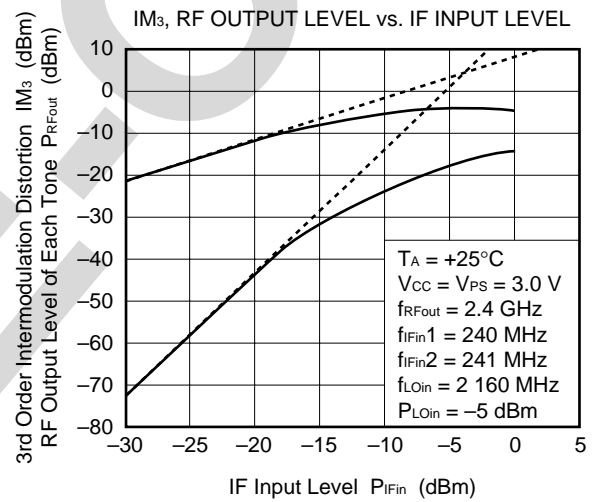
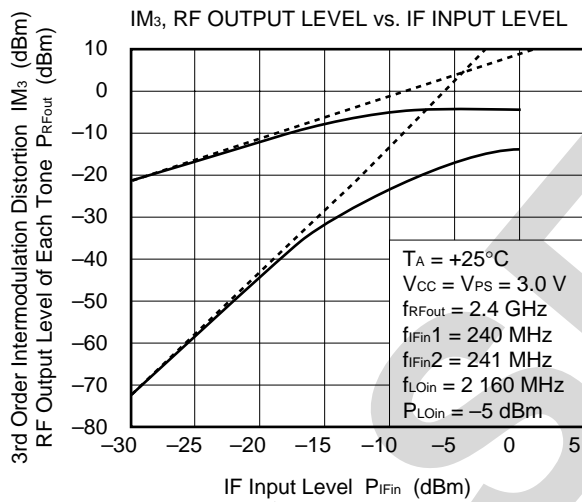
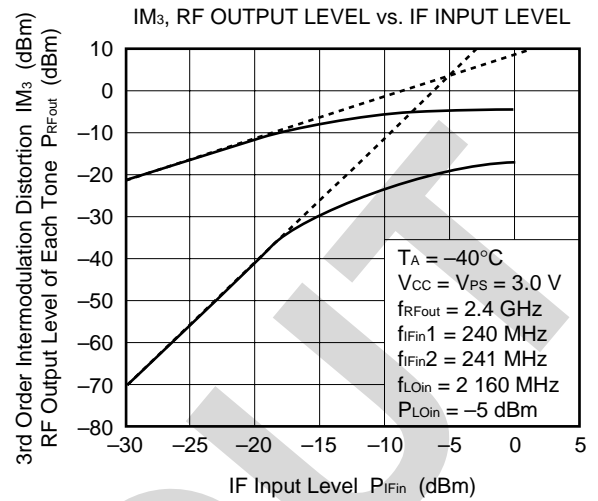
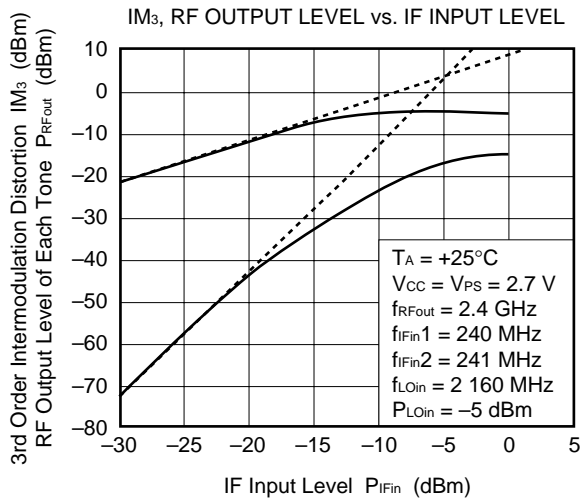

LOCAL LEAKAGE AT IF PIN vs. LOCAL INPUT FREQUENCY

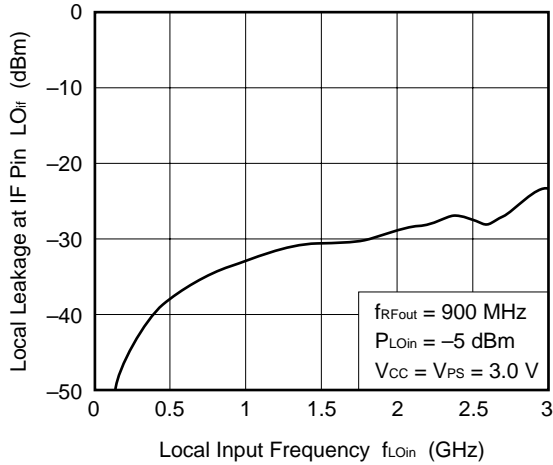

LOCAL LEAKAGE AT IF PIN vs. LOCAL INPUT FREQUENCY

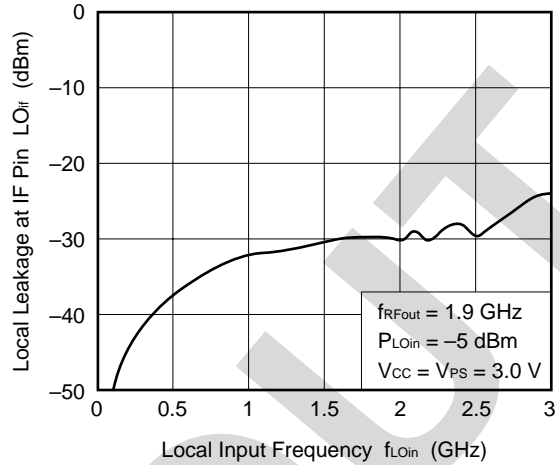

LOCAL LEAKAGE AT RF PIN vs. LOCAL INPUT FREQUENCY

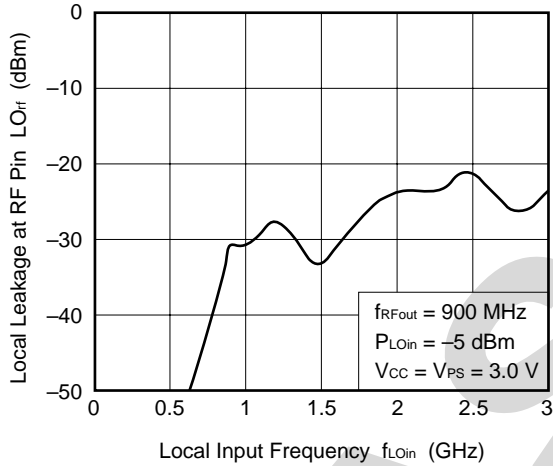

LOCAL LEAKAGE AT RF PIN vs. LOCAL INPUT FREQUENCY

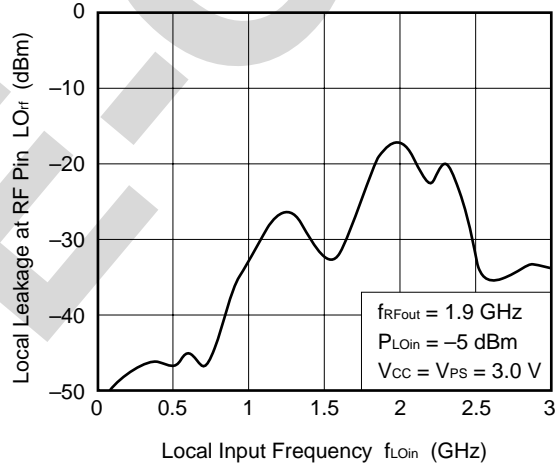

IF LEAKAGE AT RF PIN vs. IF INPUT FREQUENCY

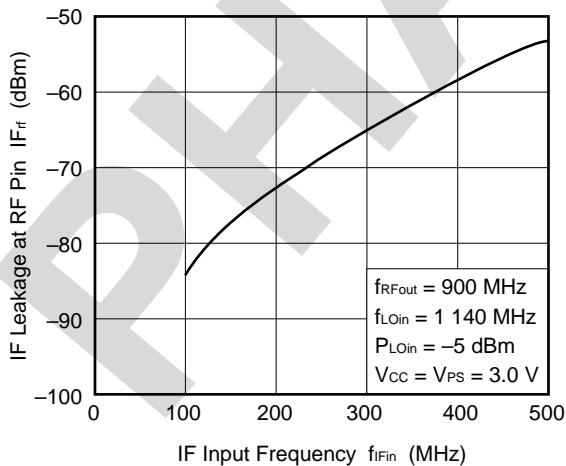

IF LEAKAGE AT RF PIN vs. IF INPUT FREQUENCY

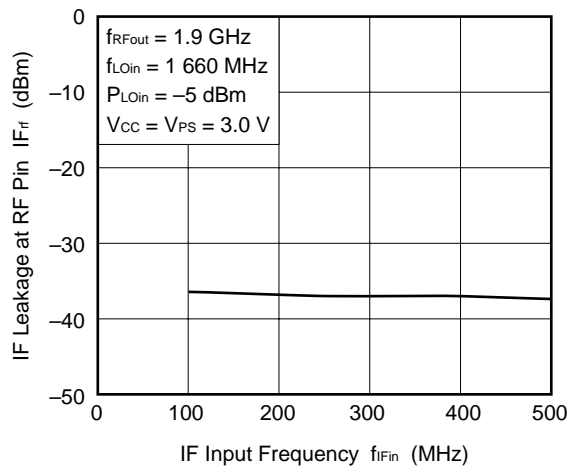

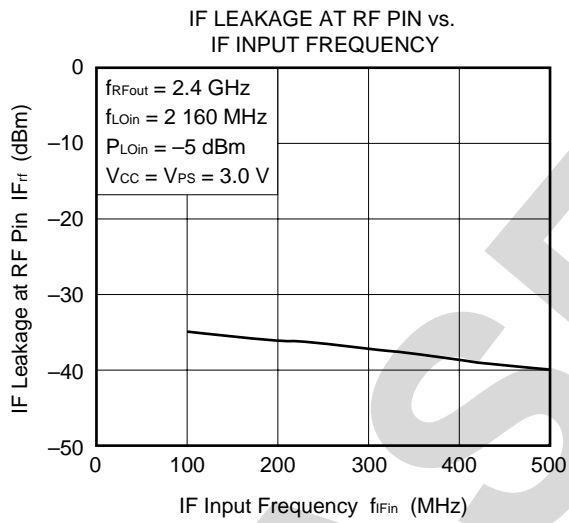
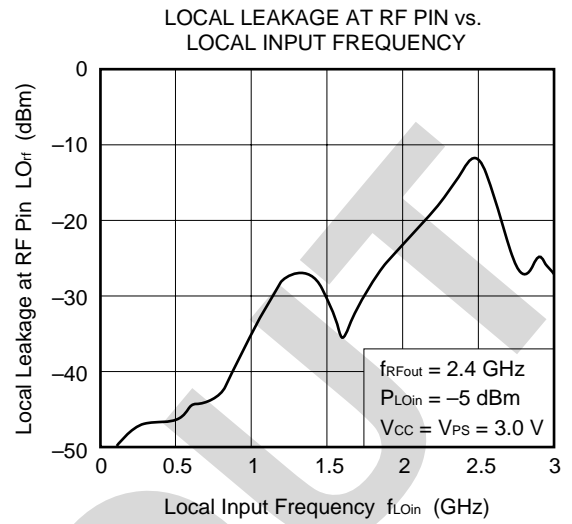
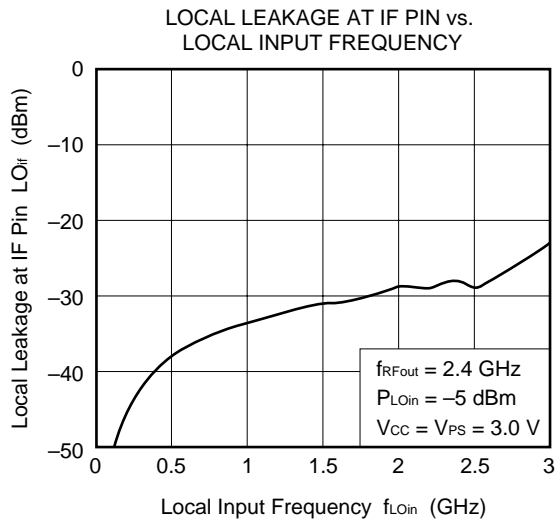

Remark The graphs indicate nominal characteristics.

★ 8. PACKAGE DIMENSIONS

6-PIN SUPER MINIMOLD (UNIT: mm)

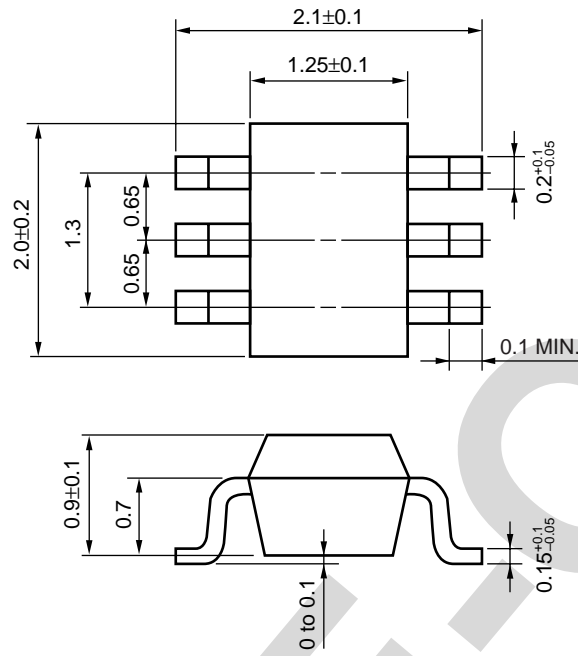

9. NOTE ON CORRECT USE

- (1) Observe precautions for handling because of electrostatic sensitive devices.
- (2) Form a ground pattern as wide as possible to minimize ground impedance (to prevent undesired oscillation).
- (3) Connect a bypass capacitor (example: 1 000 pF) to the V_{CC} pin.
- (4) Connect a matching circuit to the RF output pin.
- (5) The DC cut capacitor must be each attached to the input and output pins.

10. RECOMMENDED SOLDERING CONDITIONS

This product should be soldered under the following recommended conditions.

Soldering Method	Soldering Conditions	Recommended Condition Symbol
Infrared Reflow	Package peak temperature: 235°C or below Time: 30 seconds or less (at 210°C) Count: 3, Exposure limit: None ^{Note}	IR35-00-3
VPS	Package peak temperature: 215°C or below Time: 40 seconds or less (at 200°C) Count: 3, Exposure limit: None ^{Note}	VP15-00-3
Wave Soldering	Soldering bath temperature: 260°C or below Time: 10 seconds or less Count: 1, Exposure limit: None ^{Note}	WS60-00-1
Partial Heating	Pin temperature: 300°C Time: 3 seconds or less (per side of device) Exposure limit: None ^{Note}	–

Note After opening the dry pack, keep it in a place below 25°C and 65% RH for the allowable storage period.

Caution Do not use different soldering methods together (except for partial heating).

For details of recommended soldering conditions for surface mounting, refer to information document SEMICONDUCTOR DEVICE MOUNTING TECHNOLOGY MANUAL (C10535E).

NOTICE

1. Descriptions of circuits, software and other related information in this document are provided only to illustrate the operation of semiconductor products and application examples. You are fully responsible for the incorporation of these circuits, software, and information in the design of your equipment. California Eastern Laboratories and Renesas Electronics assumes no responsibility for any losses incurred by you or third parties arising from the use of these circuits, software, or information.
2. California Eastern Laboratories has used reasonable care in preparing the information included in this document, but California Eastern Laboratories does not warrant that such information is error free. California Eastern Laboratories and Renesas Electronics assumes no liability whatsoever for any damages incurred by you resulting from errors in or omissions from the information included herein.
3. California Eastern Laboratories and Renesas Electronics do not assume any liability for infringement of patents, copyrights, or other intellectual property rights of third parties by or arising from the use of Renesas Electronics products or technical information described in this document. No license, express, implied or otherwise, is granted hereby under any patents, copyrights or other intellectual property rights of California Eastern Laboratories or Renesas Electronics or others.
4. You should not alter, modify, copy, or otherwise misappropriate any Renesas Electronics product, whether in whole or in part. California Eastern Laboratories and Renesas Electronics assume no responsibility for any losses incurred by you or third parties arising from such alteration, modification, copy or otherwise misappropriation of Renesas Electronics product.
5. Renesas Electronics products are classified according to the following two quality grades: "Standard" and "High Quality". The recommended applications for each Renesas Electronics product depends on the product's quality grade, as indicated below. "Standard": Computers; office equipment; communications equipment; test and measurement equipment; audio and visual equipment; home electronic appliances; machine tools; personal electronic equipment; and industrial robots etc. "High Quality": Transportation equipment (automobiles, trains, ships, etc.); traffic control systems; anti-disaster systems; anti-crime systems; and safety equipment etc. Renesas Electronics products are neither intended nor authorized for use in products or systems that may pose a direct threat to human life or bodily injury (artificial life support devices or systems, surgical implantations etc.), or may cause serious property damages (nuclear reactor control systems, military equipment etc.). You must check the quality grade of each Renesas Electronics product before using it in a particular application. You may not use any Renesas Electronics product for any application for which it is not intended. California Eastern Laboratories and Renesas Electronics shall not be in any way liable for any damages or losses incurred by you or third parties arising from the use of any Renesas Electronics product for which the product is not intended by California Eastern Laboratories or Renesas Electronics.
6. You should use the Renesas Electronics products described in this document within the range specified by California Eastern Laboratories, especially with respect to the maximum rating, operating supply voltage range, movement power voltage range, heat radiation characteristics, installation and other product characteristics. California Eastern Laboratories shall have no liability for malfunctions or damages arising out of the use of Renesas Electronics products beyond such specified ranges.
7. Although Renesas Electronics endeavors to improve the quality and reliability of its products, semiconductor products have specific characteristics such as the occurrence of failure at a certain rate and malfunctions under certain use conditions. Further, Renesas Electronics products are not subject to radiation resistance design. Please be sure to implement safety measures to guard them against the possibility of physical injury, and injury or damage caused by fire in the event of the failure of a Renesas Electronics product, such as safety design for hardware and software including but not limited to redundancy, fire control and malfunction prevention, appropriate treatment for aging degradation or any other appropriate measures. Because the evaluation of microcomputer software alone is very difficult, please evaluate the safety of the final products or systems manufactured by you.
8. Please contact a California Eastern Laboratories sales office for details as to environmental matters such as the environmental compatibility of each Renesas Electronics product. Please use Renesas Electronics products in compliance with all applicable laws and regulations that regulate the inclusion or use of controlled substances, including without limitation, the EU RoHS Directive. California Eastern Laboratories and Renesas Electronics assume no liability for damages or losses occurring as a result of your noncompliance with applicable laws and regulations.
9. Renesas Electronics products and technology may not be used for or incorporated into any products or systems whose manufacture, use, or sale is prohibited under any applicable domestic or foreign laws or regulations. You should not use Renesas Electronics products or technology described in this document for any purpose relating to military applications or use by the military, including but not limited to the development of weapons of mass destruction. When exporting the Renesas Electronics products or technology described in this document, you should comply with the applicable export control laws and regulations and follow the procedures required by such laws and regulations.
10. It is the responsibility of the buyer or distributor of California Eastern Laboratories, who distributes, disposes of, or otherwise places the Renesas Electronics product with a third party, to notify such third party in advance of the contents and conditions set forth in this document, California Eastern Laboratories and Renesas Electronics assume no responsibility for any losses incurred by you or third parties as a result of unauthorized use of Renesas Electronics products.
11. This document may not be reproduced or duplicated in any form, in whole or in part, without prior written consent of California Eastern Laboratories.
12. Please contact a California Eastern Laboratories sales office if you have any questions regarding the information contained in this document or Renesas Electronics products, or if you have any other inquiries.

NOTE 1: "Renesas Electronics" as used in this document means Renesas Electronics Corporation and also includes its majority-owned subsidiaries.

NOTE 2: "Renesas Electronics product(s)" means any product developed or manufactured by or for Renesas Electronics.

NOTE 3: Products and product information are subject to change without notice.

CEL Headquarters • 4590 Patrick Henry Drive, Santa Clara, CA 95054 • Phone (408) 919-2500 • www.cel.com

For a complete list of sales offices, representatives and distributors,
Please visit our website: www.cel.com/contactus

Mouser Electronics

Authorized Distributor

Click to View Pricing, Inventory, Delivery & Lifecycle Information:

CEL:

[UPC8172TB-A](#) [UPC8172TB-EV09](#) [UPC8172TB-EV24](#) [UPC8172TB-EV19](#)