

# TDP Series Ultra-miniature Surface Mount Half-pitch Side-Actuated DIP Switches



H  
DIP

## Features/Benefits

- World's first ultra-miniature SMT half-pitch side-actuated DIP
- Side actuation allows visual indication of on/off position in horizontal applications
- Process sealed for surface mount soldering and washable processing
- RoHS compliant
- Lead free

## Typical Applications

- Hand-held electronic devices
- Portable computer and electronic devices
- Instrumentation and controls



## Specifications

SWITCH FUNCTION: SPST — 2, 4, 6, 8, 10 positions.

CONTACT RATING:

24 V DC, 25 mA (switching).

50 V DC, 100 mA (steady state).

MECHANICAL AND ELECTRICAL LIFE: 1,000 cycles.

CONTACT RESISTANCE: 100 mΩ max.

INSULATION RESISTANCE: 100 MΩ @ 100 V DC min.

DIELECTRIC STRENGTH: 300 V AC min.

STORAGE TEMPERATURE: -40°C to 85°C.

OPERATING TEMPERATURE: -40°C to 85°C.

OPERATING FORCE: 4.9N max.

SOLDERABILITY: Per MIL-STD-202F method 208D, or

EIA RS-186E method 9 (1 hour steam aging).

PACKAGING: Switches supplied in rigid dispensing tubes in full tube quantities only, this may affect order quantity. Tape and reel packaging also available.

## Materials

CASE & COVER: glass filled PPS (UL94V-0).

ACTUATOR: PA6T (UL94V-0).

CONTACTS: Copper alloy with gold plate over nickel plate.

TERMINALS: Copper alloy, with gold over nickel plate.

All terminals are insert molded.

TAPE SEAL: Polyimide.

**Note:** Specifications and materials listed above are for switches with standard options. For information on specific and custom switches, consult Customer Service Center.

## How To Order

The Build-A Switch concept allows you to mix and match options to create the switch you need. Below is a complete listing of options shown in catalog. To order, simply select desired option from each category and place in the appropriate box.

All switches supplied in "OFF" position.

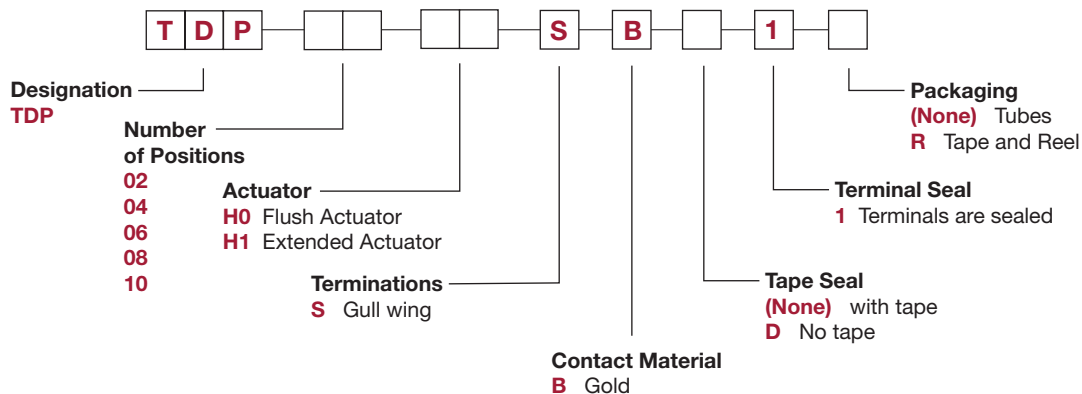

**Note:** Tape seal is not available with H1 Extended Actuators.



Dimensions are shown: Inch (mm)  
Specifications and dimensions subject to change



# TDP Series Ultra-miniature Surface Mount Half-pitch Side-Actuated DIP Switches



DIP H

## Flush Actuator-No Top Tape, Surface Mount Terminals

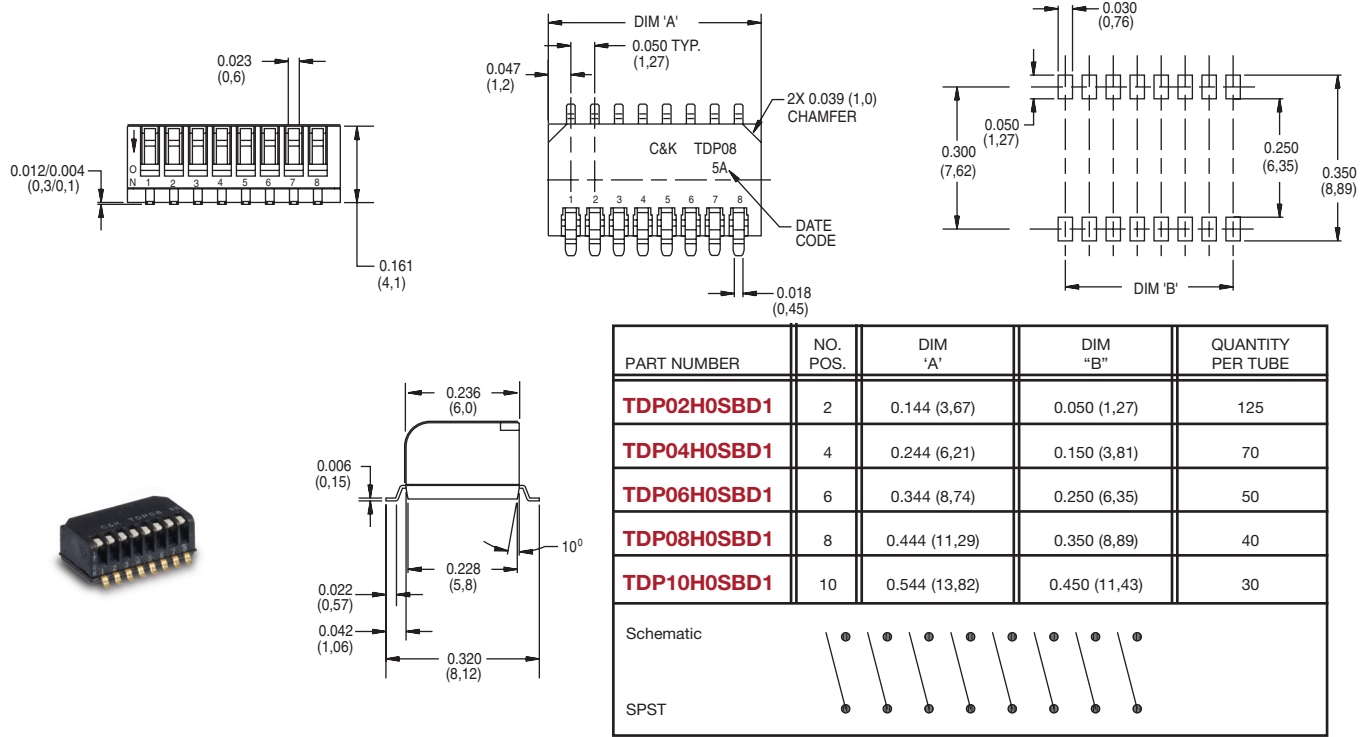

## Flush Actuator-with Top Tape, Surface Mount Terminals

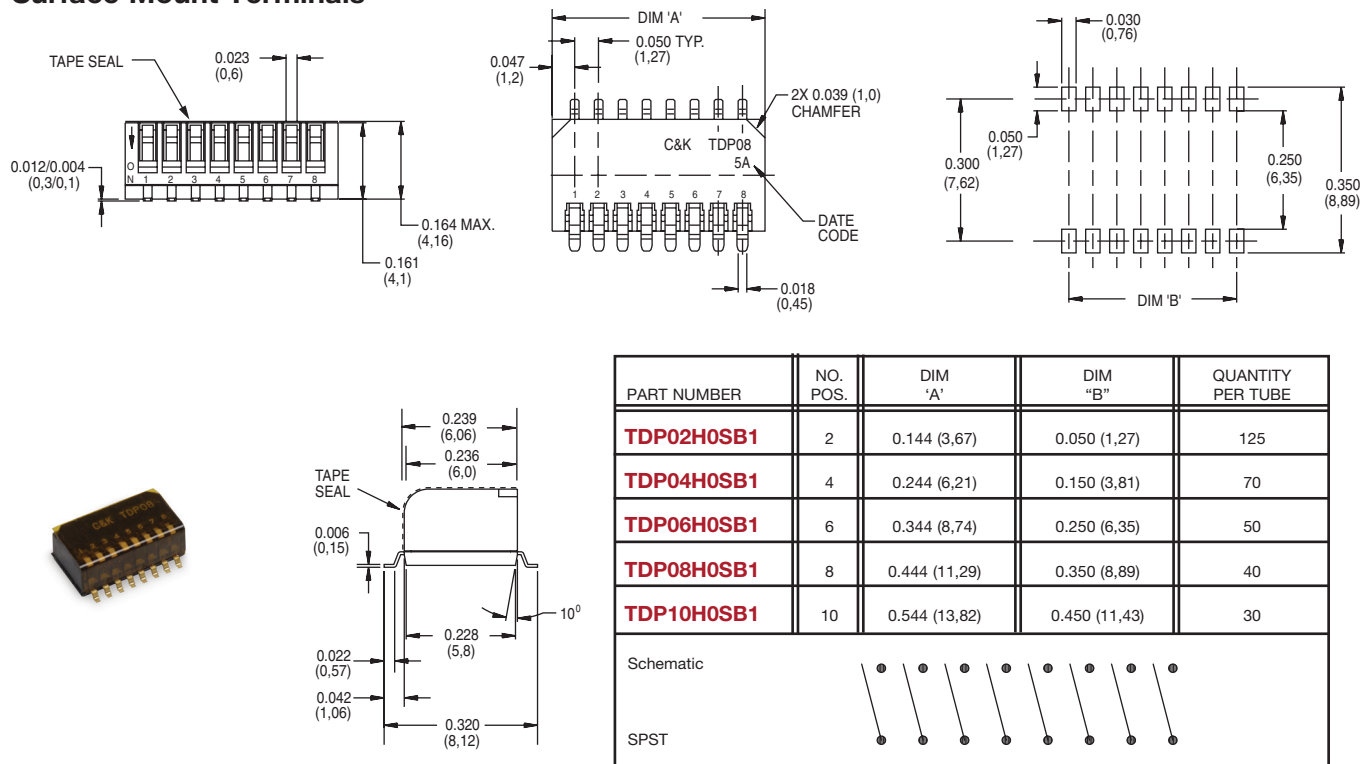

Dimensions are shown: Inch (mm)  
Specifications and dimensions subject to change



# TDP Series Ultra-miniature Surface Mount Half-pitch Side-Actuated DIP Switches



H DIP

## Extended Actuator-No Top Tape, Surface Mount Terminals

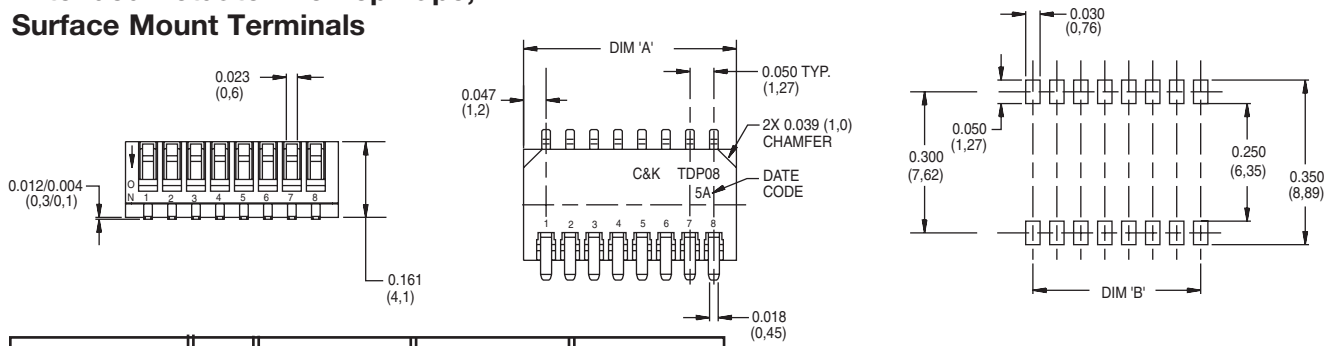

PART NUMBER	NO. POS.	DIM 'A'	DIM 'B'	QUANTITY PER TUBE
<b>TDP02H1SBD1</b>	2	0.144 (3,67)	0.050 (1,27)	125
<b>TDP04H1SBD1</b>	4	0.244 (6,21)	0.150 (3,81)	70
<b>TDP06H1SBD1</b>	6	0.344 (8,74)	0.250 (6,35)	50
<b>TDP08H1SBD1</b>	8	0.444 (11,29)	0.350 (8,89)	40
<b>TDP10H1SBD1</b>	10	0.544 (13,82)	0.450 (11,43)	30

Schematic

SPST

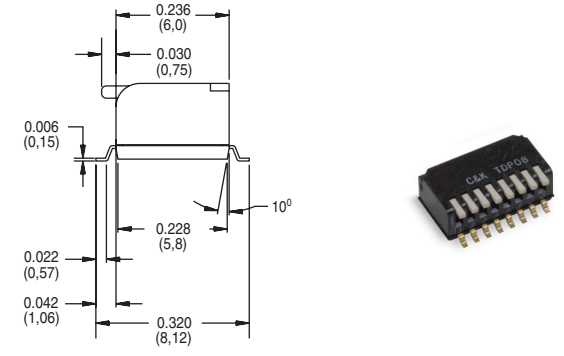

## Tube Packaging

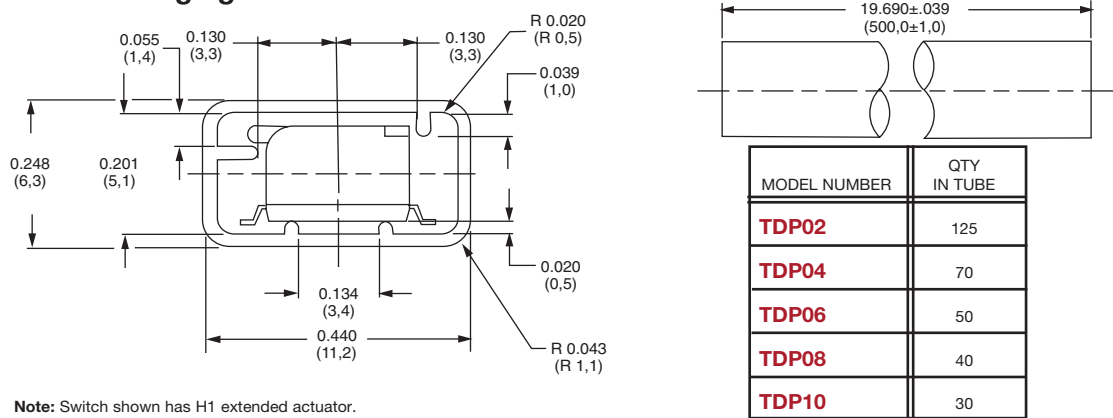

Note: Switch shown has H1 extended actuator.

## Tape and Reel Packaging

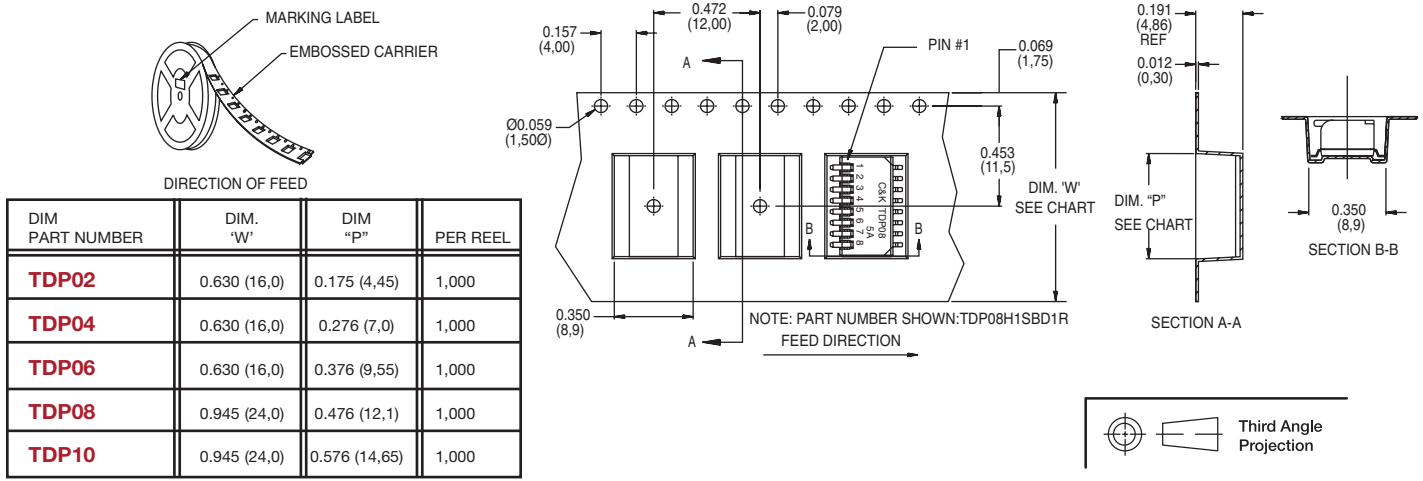

Dimensions are shown: Inch (mm)  
Specifications and dimensions subject to change

# Mouser Electronics

Authorized Distributor

Click to View Pricing, Inventory, Delivery & Lifecycle Information:

## C&K Switches:

[TDP02H0SBD1R](#) [TDP04H0SBD1R](#) [TDP08H0SBD1R](#) [TDP10H1SBD1R](#) [TDP02H0SB1](#) [TDP02H1SBD1](#)  
[TDP02H1SBD1R](#) [TDP04H0SB1](#) [TDP04H1SBD1](#) [TDP04H1SBD1R](#) [TDP08H0SB1](#) [TDP08H1SBD1](#) [TDP08H1SBD1R](#)  
[TDP04H0SBD1](#) [TDP02H0SBD1](#) [TDP08H0SBD1](#) [TDP06H1SBD1](#) [TDP06H0SB1](#) [TDP10H1SBD1](#) [TDP04H0SB1R](#)  
[TDP10H0SBD1](#) [TDP08H0SB1R](#)