

RITA-WAS

Asymmetric beam for wall-washing

TECHNICAL SPECIFICATIONS:

Dimensions	31.9 x 28.4 mm
Height	17.1 mm
Fastening	glue, pin
Colour	white
Box size	
Box weight	8 kg
Quantity in Box	900 pcs
ROHS compliant	yes ⓘ



MATERIAL SPECIFICATIONS:

Component	Type	Material	Colour	Coating
RITA-WAS	Reflector	HRPC	white	

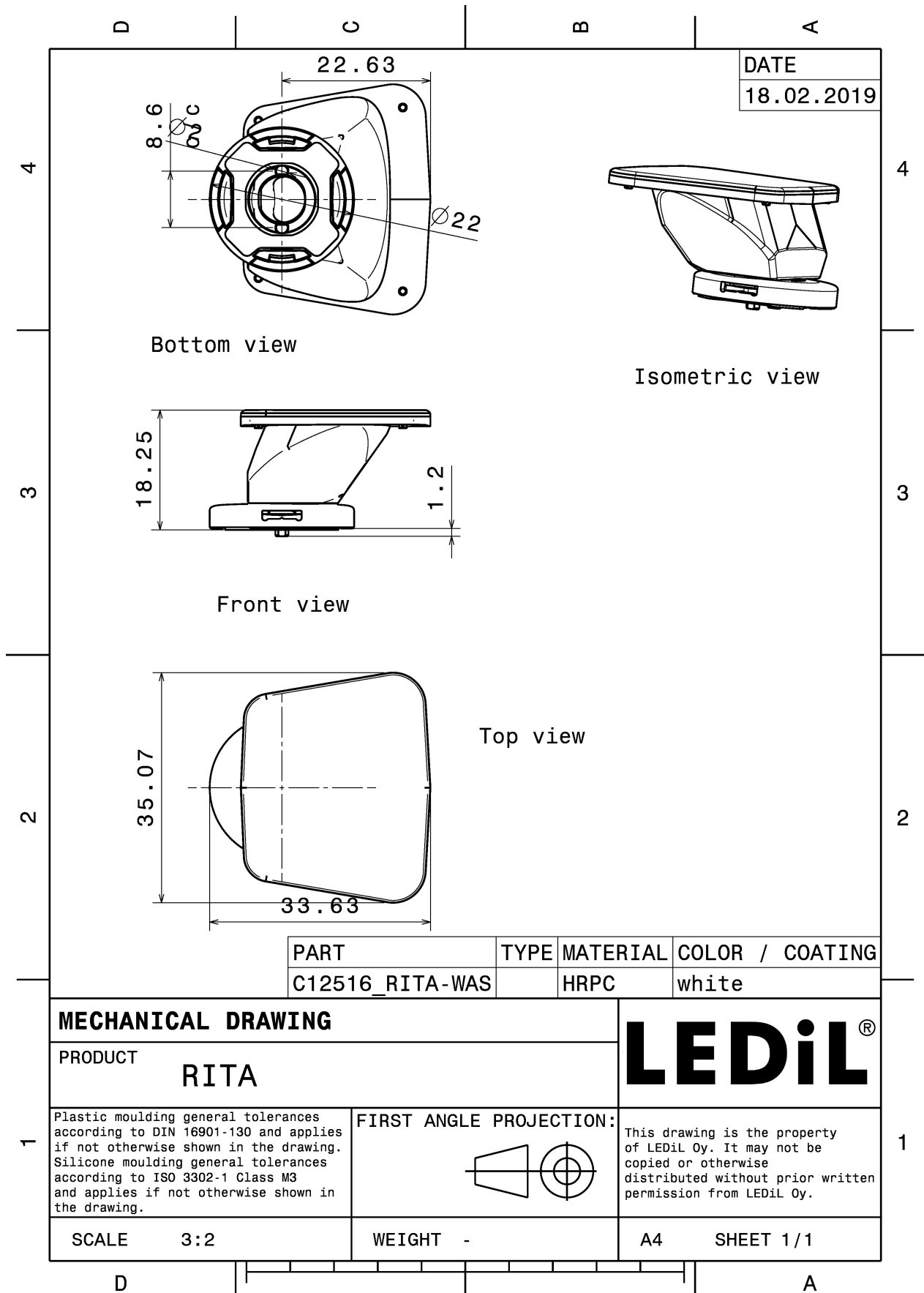

PHOTOMETRIC DATA (MEASURED):

CREE

LED XM-L
 FWHM Asymmetric
 Efficiency 84 %
 Peak intensity 0.611 cd/lm
 LEDs/each optic 1
 Light colour White
 Required components:



CREE

LED XM-L2
 FWHM Asymmetric
 Efficiency 83 %
 Peak intensity 0.600 cd/lm
 LEDs/each optic 1
 Light colour White
 Required components:

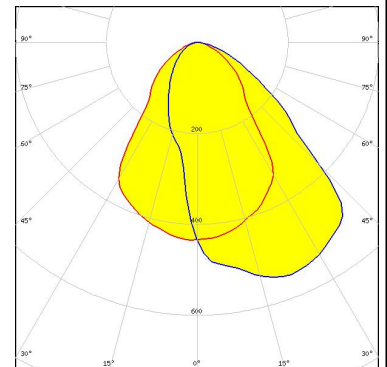
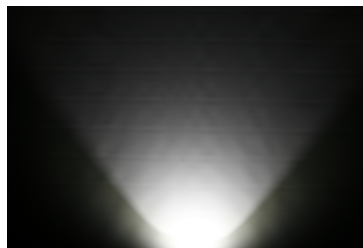

CREE

LED XP-E
 FWHM Asymmetric
 Efficiency 83 %
 Peak intensity 0.634 cd/lm
 LEDs/each optic 1
 Light colour White
 Required components:

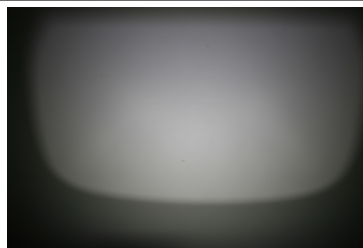

CREE

LED XP-G
 FWHM Asymmetric
 Efficiency 85 %
 Peak intensity 0.630 cd/lm
 LEDs/each optic 1
 Light colour White
 Required components:



PHOTOMETRIC DATA (MEASURED):

CREE

LED XP-G2
 FWHM Asymmetric
 Efficiency 85 %
 Peak intensity 0.657 cd/lm
 LEDs/each optic 1
 Light colour White
 Required components:



CREE

LED XT-E
 FWHM Asymmetric
 Efficiency 84 %
 Peak intensity 0.640 cd/lm
 LEDs/each optic 1
 Light colour White
 Required components:



LUMILEDS

LED LUXEON A
 FWHM Asymmetric
 Efficiency 86 %
 Peak intensity 0.680 cd/lm
 LEDs/each optic 1
 Light colour White
 Required components:

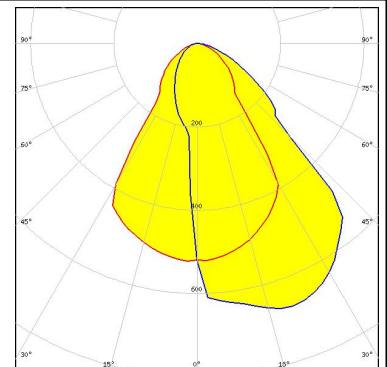
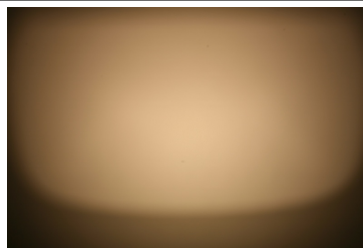

LUMILEDS

LED LUXEON M/MX
 FWHM Asymmetric
 Efficiency 85 %
 Peak intensity 0.638 cd/lm
 LEDs/each optic 1
 Light colour White
 Required components:

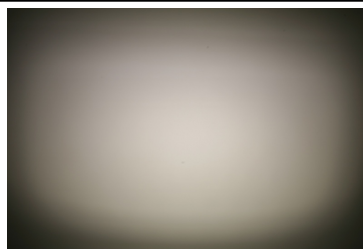

PHOTOMETRIC DATA (MEASURED):

LUMILEDS

LED LUXEON MZ
FWHM Asymmetric
Efficiency 84 %
Peak intensity 0.600 cd/lm
LEDs/each optic 1
Light colour White
Required components:

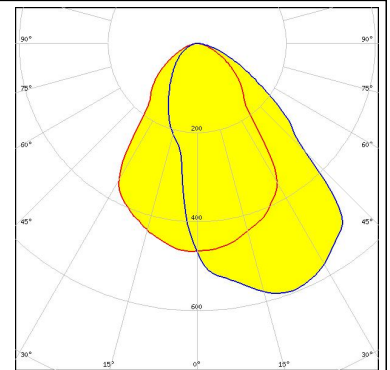

LUMILEDS

LED LUXEON T
FWHM Asymmetric
Efficiency 84 %
Peak intensity 0.600 cd/lm
LEDs/each optic 1
Light colour White
Required components:

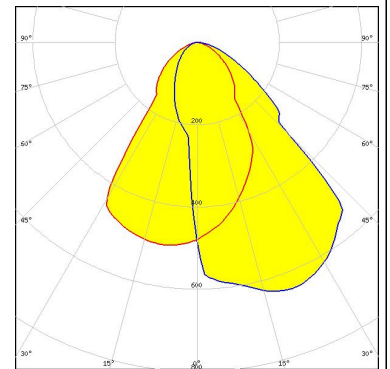

LUMILEDS

LED LUXEON TX
FWHM Asymmetric
Efficiency 84 %
Peak intensity 0.620 cd/lm
LEDs/each optic 1
Light colour White
Required components:

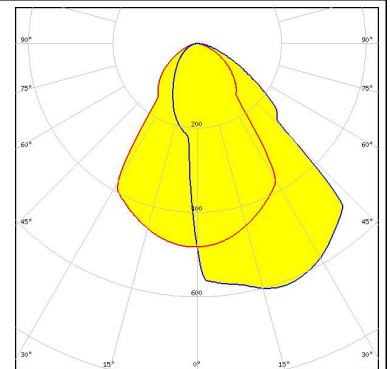
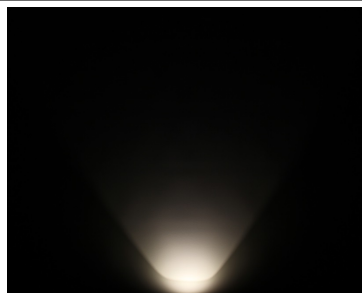

NICHIA

LED NS9x383
FWHM Asymmetric
Efficiency 85 %
Peak intensity 0.630 cd/lm
LEDs/each optic 1
Light colour White
Required components:

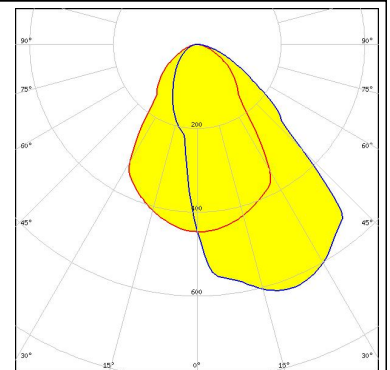

PHOTOMETRIC DATA (MEASURED):



LED NVSxx19B/NVSxx19C
FWHM Asymmetric
Efficiency 83 %
Peak intensity 0.600 cd/lm
LEDs/each optic 1
Light colour White
Required components:

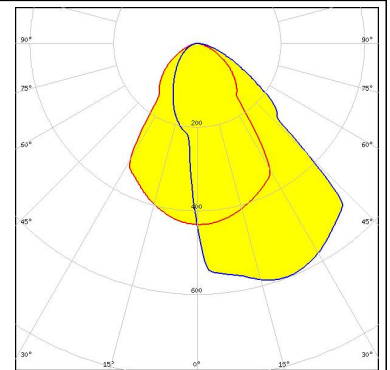

LED OSOLON Square EC
FWHM Asymmetric
Efficiency 84 %
Peak intensity 0.654 cd/lm
LEDs/each optic 1
Light colour White
Required components:



PHOTOMETRIC DATA (SIMULATED):



LED	LUXEON H50-2
FWHM	Asymmetric
Efficiency	%
Peak intensity	cd/m
LEDs/each optic	1
Light colour	White
Required components:	

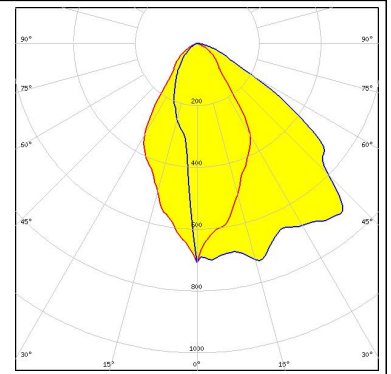

GENERAL INFORMATION:

NOTE: The typical beam angle will be changed by different color, chip size and chip position tolerance. The typical total beam angle is the full angle measured where the luminous intensity is half of the peak value.

MATERIALS:

As part of our continuous research and improvement processes, and to ensure the best possible quality and availability of our products, LEDiL reserves the right to change material grades without notice.

PRODUCT DATA USER AGREEMENT AND DISCLAIMER:

The measured data in the provided downloadable LEDiL Product Datasheets and Mechanical 2D-Drawings is rounded and provided as reference for planning. LEDiL Oy's optical specifications have been verified by conducting performance testing of the products in accordance with the company's quality system. The reported data are averaged results of multiple measurements with typical variation. LEDiL Oy reserves the right to without prior notification make changes and improvements to its products.

LEDiL Oy assumes neither warranty, nor guarantee nor any other liability of any kind for the contents and correctness of the provided data. The provided data has been generated with highest diligence but the provided data may in reality not represent the complete possible variation range of all intrinsic parameters. Therefore, in certain cases a deviation from the provided data could occur.

LEDiL Oy reserves the right to undertake technical changes of its products without further notification which could lead to changes in the provided data. LEDiL Oy assumes no liability of any kind for the possible deviation from any provided data or any other damage resulting from the usage of the provided data.

The user agrees to this disclaimer and user agreement with the download or usage of the provided files.

LEDiL Oy

Joensuunkatu 13
FI-24240 SALO
Finland

LEDiL Inc.

228 West Page Street
Suite D
Sycamore IL 60178
USA

Local sales and technical support

[www.ledil.com/
where_to_buy](http://www.ledil.com/where_to_buy)

Shipping locations

Salo, Finland
Hong Kong, China

Distribution Partners

[www.ledil.com/
where_to_buy](http://www.ledil.com/where_to_buy)

Mouser Electronics

Authorized Distributor

Click to View Pricing, Inventory, Delivery & Lifecycle Information:

[Ledi:](#)

[C12516_RITA-WAS](#)