

SYMBOL DEFINITION		MISSING NUMBERS	
A DIMENSION WITHOUT AN INSPECTION REPORT SYMBOL  DOES NOT REQUIRE INSPECTION. IT MAY BE CONTROLLED ON AN INDIVIDUAL COMPONENT DRAWING.	TOTAL NO. OF SYMBOLS ON DRAWING	16	
	LAST NO. USED	18	

DWG STATUS					ZONE	REVISION HISTORY	AUTH	DR	APVD1	APVD2
DATE	STG	REV	N/P	CHG						
30MY02	R	05	-	-		ALL PARTS - CLEARED REV COLUMN & REVISED MAT'L SPECS; 15304701 & 15304702 - UPDATED PDM ATTRIBUTES	222820	HAM	HAM	DLB
070C02	R	06	-	-		ALL PARTS - UPDATED PDM ATTRIBUTES	227306	JHN	FRG	TTP
24JA03	R	07	-	-		ADVANCED REVISION LEVEL	235918	LMB	LMB	TV
23JA04	R	08	-	-		ADVANCED REVISION LEVEL	251141	LMB	LMB	LN
040C04	R	09	-	-		ALL PARTS - ADDED STAMP DIE I.D.	259308	RTV	JVM	MKM
130C04	R	10	-	-		ADVANCED REVISION LEVEL	259807	GPS	AUG	MY

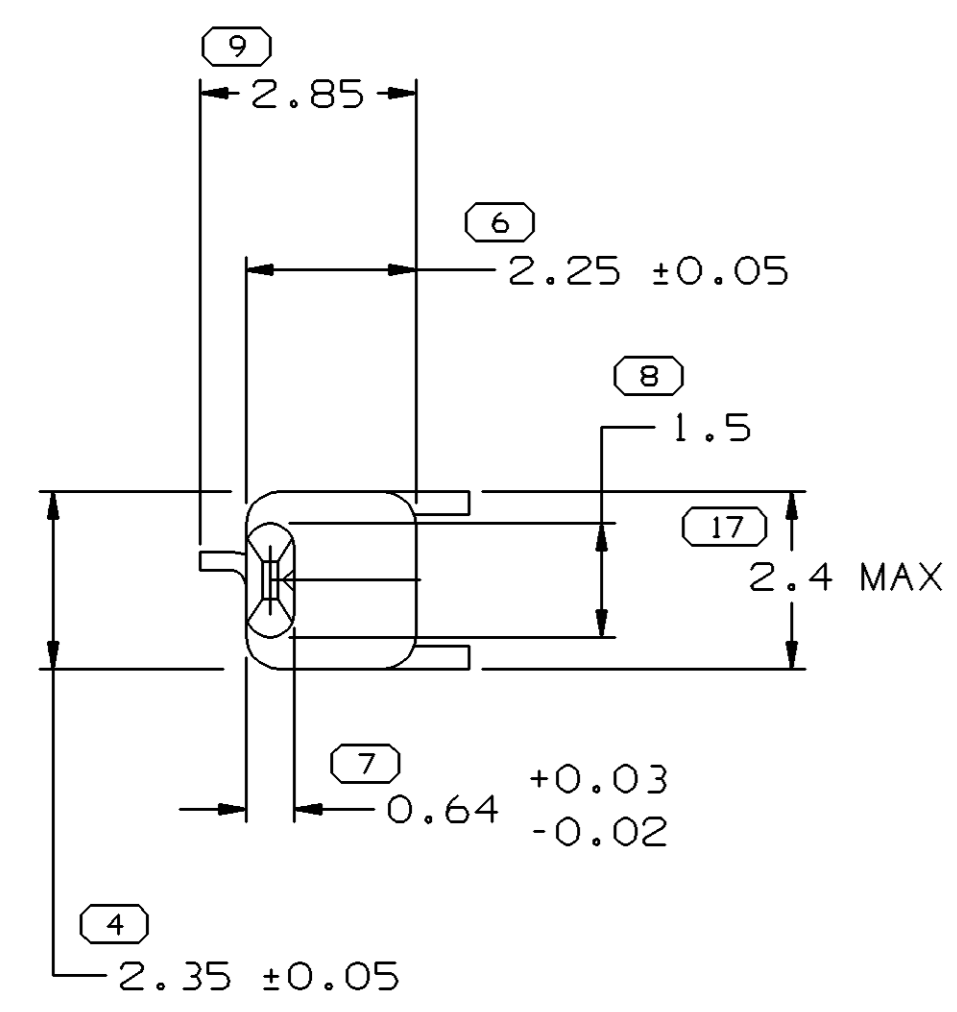

VIEW TO Y-Y

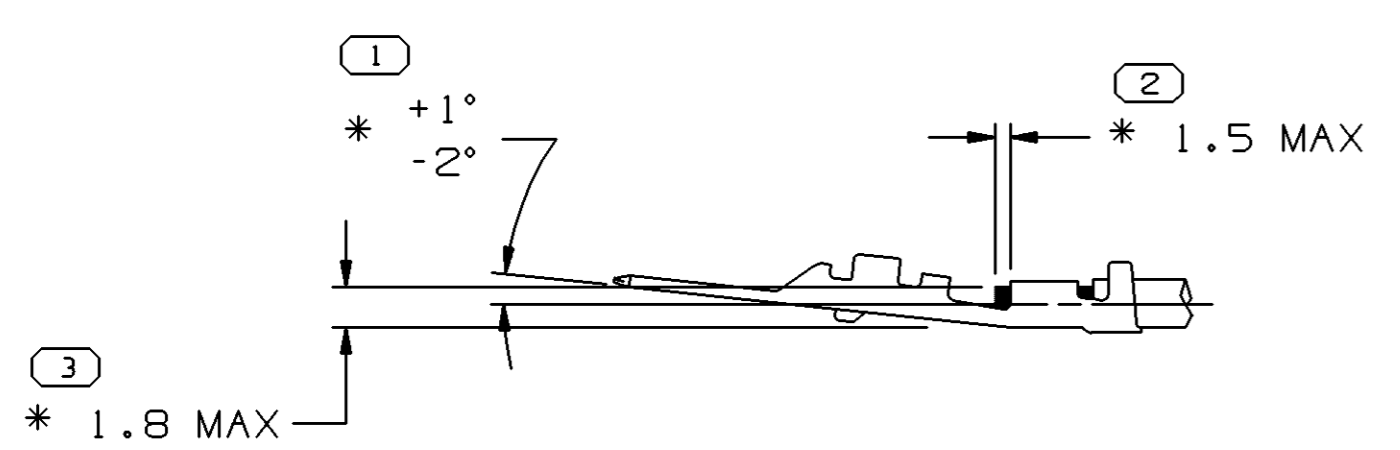
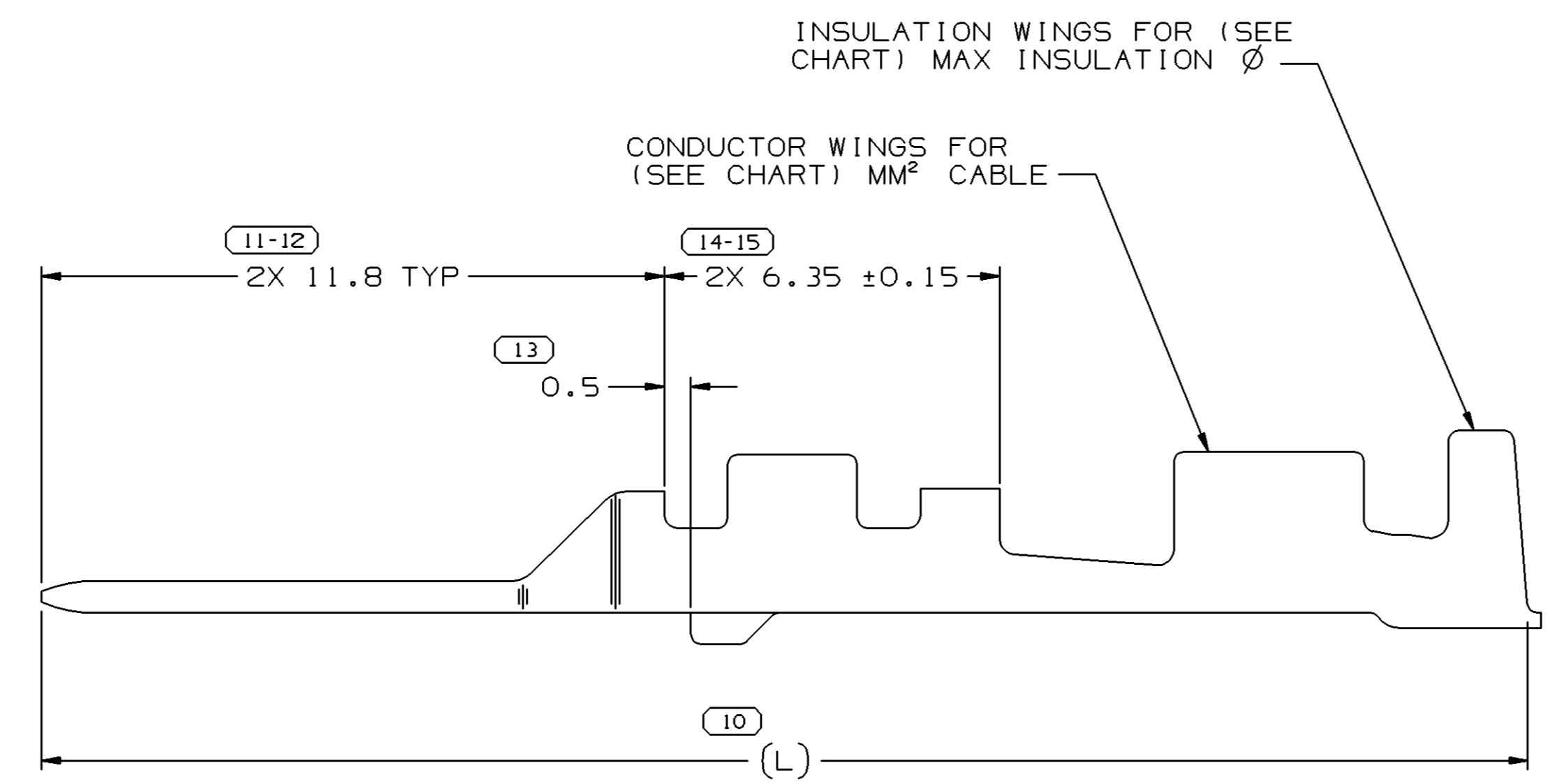
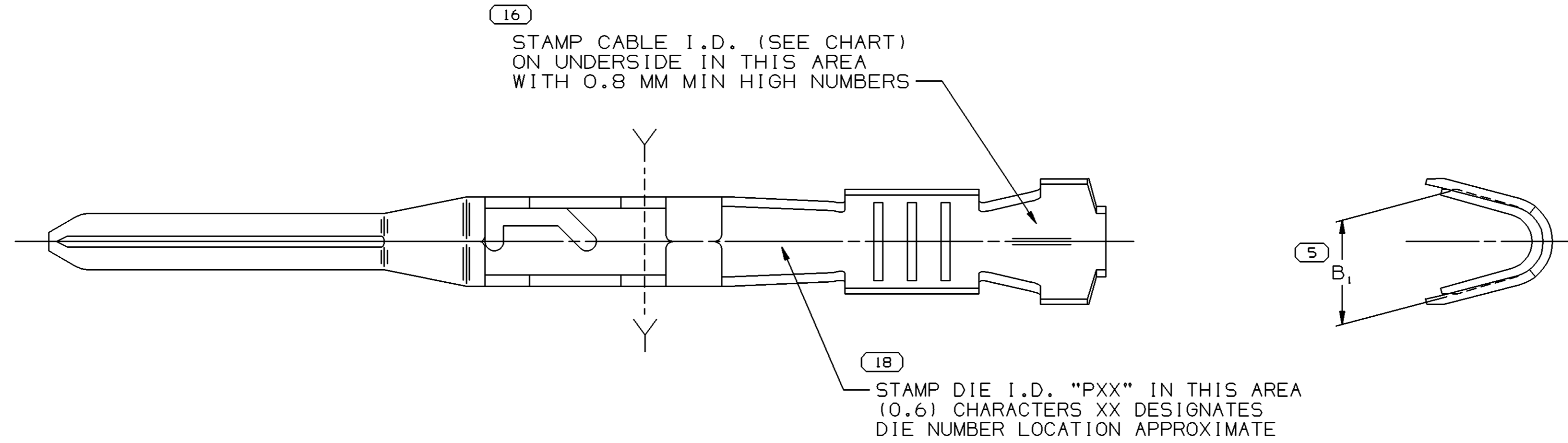

TERMINAL AND CABLE ALIGNMENT
SCALE 2:1

- NOTES
1. REFERENCE MATING COMPONENTS OR EQUIVALENT. TERMINAL 12191811
 2. "*" DENOTES DIMENSIONS MADE AT CUT-OFF AND CRIMP DIE.
 3. UNLESS OTHERWISE SPECIFIED AND/OR INDICATED: DIMENSIONS ARE TO FACE OF VIEW SHOWN AND AUTOMATICALLY ROUNDED BY COMPUTER FOR INSPECTION. (SEE MATH MODEL FOR PRECISE DIMENSIONS.) FOR ALL OTHER DIMENSIONS NOT SHOWN BUT REQUIRED FOR TOOL BUILD, SEE MATH MODEL FOR PRECISE TOOL PATH DATA.

PART NO	REV	N/P	STATUS	MAT'L SIZE	MAT'L SPEC	SIZE (MM²)	I.D.	DIA	TYPE	B ₁ ±0.2	(L)
15326397	B5	-	RESTRICTED	0.3 X 36.12	M3659A24 425 TIN BRS EX HD SN REFLO	1 - 1.5	15	2.4 - 1.9	101	2.95	28.15
15317757	B5	-		0.3 X 36.12	M3659A24 425 TIN BRS EX HD SN REFLO	0.35 - 0.5	21	1.1 - 1.3	101	2.1	28.15
15304702	D9	-		0.3 X 36.12	M3659A24 425 TIN BRS EX HD SN REFLO	0.75 - 1	17	2.25 - 1.7	101	2.65	28.15
15304701	D9	-		0.3 X 36.12	M3659A24 425 TIN BRS EX HD SN REFLO	0.35 - 0.5	21	1.85 - 1.2	101	2.1	28.15

7 PROCESS SENSITIVE DIMENSION	
DIMENSIONS ENCLOSED IN () INDICATE REFERENCE DIMENSIONS AND NO TOLERANCE LIMITS ARE ESTABLISHED	CHART D
DIMENSIONAL RANGE (MM)	FROM TO
0 - 12	±0.1
> 12	±0.2
TOLERANCE UNLESS OTHERWISE SPECIFIED	
ANGULAR TOLERANCE ±2°	

DWG TYPE: PART DRAWING

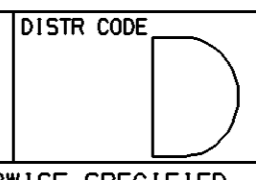
STYLE: 

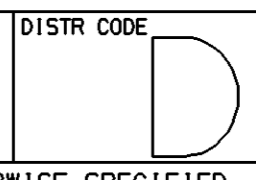
VOLUME (CM³): 

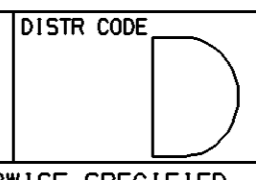
DISTR CODE: 

UNLESS OTHERWISE SPECIFIED

THIS DOCUMENT IS IN ACCORDANCE WITH ASME Y14.5M-1994 AS AMENDED BY THE GM GLOBAL DIMENSIONING AND TOLERANCING ADDENDUM - 1997. ALL GEOMETRIC TOLERANCES AND RELATED DATUMS APPLY RFS. RULE #1 PERFECT FORM AT MMC DOES NOT APPLY WHEN RELATIONSHIP BETWEEN FEATURES IS ESTABLISHED BY ORIENTATION OR LOCATION TOLERANCES. SEPARATE POSITION CALLOUTS MAY BE GAGED SEPARATELY, REGARDLESS OF DATUM REFERENCE. ALL DIMENSIONS ARE IN MILLIMETERS

THIRD ANGLE PROJECTION

DO NOT SCALE

USE MATH DATA



DELPHI

DELPHI PACKARD ELECTRIC SYSTEMS
WARREN, OH

DR	DATE
APVD1 N. VERGARA	06FE96
APVD2 T. STEELE	08JN96
APVD3 S. C. HSIEH	20JN96
APVD4	
APVD5	

SUBSTANCES OF CONCERN AND RECYCLED CONTENT PER DELPHI 10949001

MATERIAL SEE CHART

DRAWING NAME: TAXI TERM M GT 150

DRAWING NUMBER: 15304700

SIZE	SCALE	FRAME NO	SHEET NO	STG	REV	N/P
A1	10:1	1 OF 1	1 OF 2	R	10	-

Mouser Electronics

Authorized Distributor

Click to View Pricing, Inventory, Delivery & Lifecycle Information:

[Aptiv:](#)

[15304701-L](#) [15304702-L](#) [15326397-L](#)