

Special Load PCB Relay RP3SL

- 1 pole 16A, 1 form A (NO) contact
- For high inrush currents up to 120A
- Mono- or bistable
- 4kV/8mm coil-contact

Typical applications
Lighting control, timers, motor control, building automation.



Approvals	
VDE Cert. No. 40025448 (DC versions only), UL E214024	
Technical data of approved types on request.	

Contact Data	
Contact arrangement	1 form A (NO)
Rated voltage	250VAC
Max. switching voltage	400VAC
Rated current	
flux proof version	16A
wash tight version	12A
Limiting making current	
max. 4 s, duty factor 10 %	25A
max. 20 ms (incandescent lamp)	120A
Breaking capacity max.	
flux proof version	4000VA
wash tight version	3000VA
Contact material	AgSnO
Frequency of operation, with/without load	960/72000h ⁻¹
Operate/release time max., monostable	14/12ms
Set/reset time max., bistable	30/25ms
Bounce time max.	
monostable	5/7ms
bistable	5/15ms

Contact ratings			
Type	Contact	Load	Cycles
IEC61810			
RP3SL	A (NO)	16A, 250VAC resistive, 70°C	50x10 ³
RP7SL	A (NO)	12A, 250VAC resistive, 70°C	100x10 ³

Mechanical endurance		
monostable		>20x10 ⁶ operations
bistable		>1x10 ⁶ operations

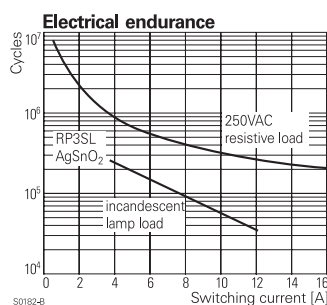
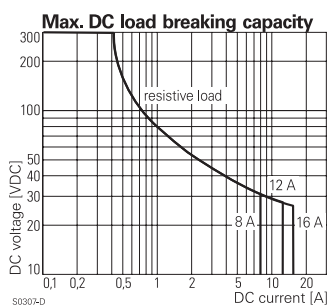

Coil Data

Coil data, monostable coil	
Coil voltage range	5 to 110VDC
Operative range, IEC 61810	
flux proof version	2
wash tight version	1

Coil versions, DC coil					
Coil code	Rated voltage VDC	Operate voltage VDC	Release voltage VDC	Coil resistance Ω±10% ¹⁾	Rated coil power mW
005	5	3.8	0.5	54	500
006	6	4.5	0.6	68	500
012	12	9.0	1.2	270	500
024	24	18.0	2.4	1100 ¹⁾	500
048	48	36.0	4.8	4400 ¹⁾	500
060	60	45.0	6.0	6540 ¹⁾	500

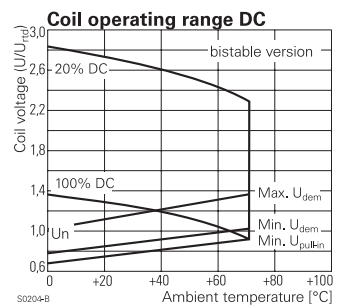
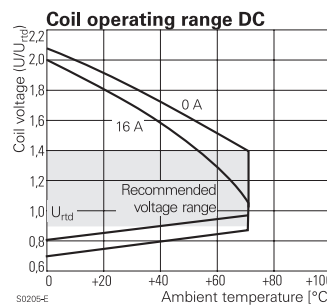

Coil Data, bistable coil		1 coil	2 coils
Coil voltage range		5 to 24VDC	
Operative range, IEC 61810		1	
Reset voltage min/max, % of U _{rtD}		70/110%	75/120%
Min./Max. energization duration		20ms/1min at < 50%DF	

Coil versions, bistable						
Coil code	Rated voltage VDC	Set voltage VDC	Reset voltage VDC	Reset R1 Ω/W	Coil resistance Ω±10% ¹⁾	Rated coil power mW
Coil versions, bistable 1 coil						
A05	5	3.7	3.6	39/0.5	21	1250
A12	12	9.0	8.7	220/0.5	115	1250
A24	24	18.0	16.7	820/0.5	460	1250
Coil versions, bistable 2 coils						
F12	12	9.0	9.0		105 ¹⁾	1250
F24	24	18.0	18.0		460 ¹⁾	1250

¹⁾ Coil resistance ±15% .
All figures are given for coil without pre-energization, at ambient temperature +23°C, duty factor 20%. Other coil voltages on request.

Special Load PCB Relay RP3SL (Continued)

Insulation Data

Initial dielectric strength	
between open contacts	2000V _{rms}
between contact and coil	4000V _{rms}
Clearance/creepage	
between contact and coil	≥8/8mm
Material group of insulation parts	
IIIa	
Tracking index of relay base	
PTI250V	

Other Data

Material compliance: EU RoHS/ELV, China RoHS, REACH, Halogen content refer to the Product Compliance Support Center at www.te.com/customersupport/rohssupportcenter

Ambient temperature	
flux proof version	-40 to +70°C
wash tight version	-40 to +35°C
Category of environmental protection	
IEC 61810	RTII - flux proof, RTIII - wash tight
Vibration resistance (functional), form A contact	
20g	
Shock resistance (destructive)	
100g	
Terminal type	
PCB-THT	
Mounting distance, 12A/16A	
0mm/≥3mm	
Weight	
18g	
Resistance to soldering heat THT, IEC 60068-2-20	
flux proof version	270°C/10s
wash tight version	260°C/5s
Packaging/unit	
monostable and bistable 1 coil version	tube/20 pcs., box/500 pcs.
bistable 2coil version	tray/25 pcs., box/100 pcs.

Circuit scheme for bistable 1 coil

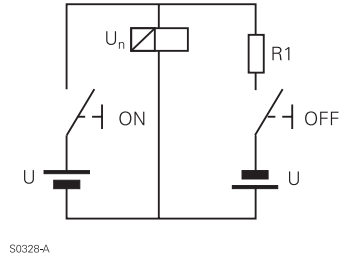

PCB layout / terminal assignment

Bottom view on solder pins

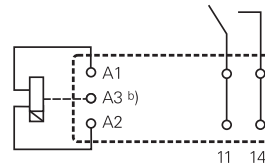
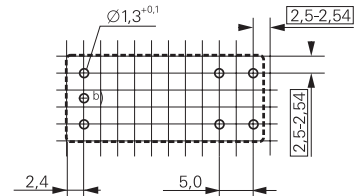

Bistable versions:
Indicated contact position during or after coil energization with reset voltage.

2-coil versions:
Operate A2, A3
Reset A1, A3

b) for 2 coil version only

Dimensions

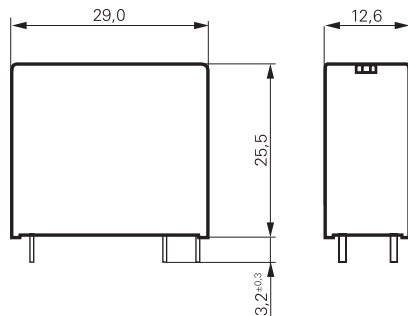

Special Load PCB Relay RP3SL (Continued)

Product code structure

Typical product code **RP 3 SL 012**

Type	RP Special Load PCB Relay RP 3 SL		
Version	3 Flux proof	7 Wash tight	
Contact configuration / contact material	SL 1 form A contact (1 NO), AgSnO ₂		
Coil	Coil code: please refer to coil versions table		

Product code	Version	Contact material	Coil version	Coil	Part number
RP3SL005	1 form A (NO) contact 16A	AgSnO	DC coil	5VDC	1393230-7
RP3SL012				12VDC	1393230-9
RP3SL018	flux proof			18VDC	1-1393230-0
RP3SL024				24VDC	1-1393230-1
RP3SL048				48VDC	1-1393230-2
RP3SL060				60VDC	1-1393230-3
RP3SLA06			Bistable 1 coil	6VDC	1393230-2
RP3SLA24				24VDC	1393230-4
RP3SLF12			Bistable 2 coils	12VDC	1393230-5

This list represents the most common types and does not show all variants covered by this datasheet.
Other types on request.

Mouser Electronics

Authorized Distributor

Click to View Pricing, Inventory, Delivery & Lifecycle Information:

[TE Connectivity:](#)

[RP3SL024](#)