

## ISL8012

2A Low Quiescent Current 1MHz High Efficiency Synchronous Buck Regulator

FN6616  
Rev 2.00  
December 1, 2011

The ISL8012 is a high efficiency, monolithic, synchronous step-down DC/DC converter that can deliver up to 2A continuous output current from a 2.7V to 5.5V input supply. It uses a current control architecture to deliver very low duty cycle operation at high frequency with fast transient response and excellent loop stability.

The ISL8012 integrates a pair of low ON-resistance P-Channel and N-Channel internal MOSFETs to maximize efficiency and minimize external component count. The 100% duty-cycle operation allows less than 240mV dropout voltage at 2A output current. High 1MHz pulse width modulation (PWM) switching frequency allows the use of small external components.

The ISL8012 can be configured for discontinuous or forced continuous operation at light load. Forced continuous operation reduces noise and RF interference while discontinuous mode provides high efficiency by reducing switching losses at light loads.

Fault protection is provided by internal current limiting during short circuit and overcurrent conditions, an output overvoltage comparator and over-temperature monitor circuit. A power-good output voltage monitor indicates when the output is in regulation.

The ISL8012 offers a 1ms Power-good (PG) timer at power-up. When shutdown, ISL8012 discharges the output capacitor. Other features include internal soft-start, internal compensation, overcurrent protection, and thermal shutdown.

The ISL8012 is offered in a space saving 3mmx3mm 10 Ld DFN package lead free package with exposed pad lead frames for low thermal. The complete converter occupies less than 0.35in<sup>2</sup> area.

## Features

- High Efficiency Synchronous Buck Regulator with up to 95% Efficiency
- Power-Good (PG) Output with a 1ms Delay
- 2.7V to 5.5V Supply Voltage
- 3% Output Accuracy Over-Temperature/Load/Line
- 2A Guaranteed Output Current
- Start-up with Pre-Biased Output
- Internal Soft-Start - 1ms
- Soft-Stop Output Discharge During Disabled
- 40µA Quiescent Supply Current in PFM Mode
- Selectable Forced PWM Mode and PFM Mode
- Less than 1µA Logic Controlled Shutdown Current
- 100% Maximum Duty Cycle
- Internal Current Mode Compensation
- Peak Current Limiting and Hiccup Mode Short Circuit Protection
- Over-Temperature Protection
- Small 10 Ld 3mmx3mm DFN
- Pb-Free (RoHS Compliant)

## Applications

- DC/DC POL Modules
- µC/µP, FPGA and DSP Power
- Plug-in DC/DC Modules for Routers and Switchers
- Portable Instruments
- Test and Measurement Systems
- Li-ion Battery Powered Devices
- Small Form Factor (SFP) Modules
- Bar Code Readers

## Related Literature

- See [AN1360](#) for "ISL8012EVAL1Z: 2A Synchronous Buck Regulator with Integrated MOSFETs"

## Pin Configuration

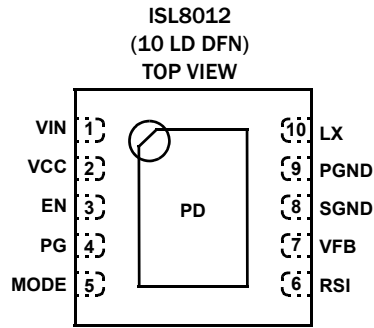

## Pin Descriptions

| SYMBOL      | PIN NUMBER | DESCRIPTION  |
|-------------|------------|--|
| VIN         | 1          | Input supply voltage. Connect a 10 $\mu$ F ceramic capacitor to power ground.  |
| VCC         | 2          | Input supply for the logic. Connect to VIN.  |
| EN          | 3          | Regulator enable pin. Enable the output when driven to high. Shutdown the chip and discharge output capacitor when driven to low. Do not leave this pin floating.  |
| PG          | 4          | 1ms timer output. At power-up or EN HI, this output is a 1ms delayed Power-Good signal for the output voltage. This output can be reset by a low RSI signal. 1ms starts when RSI goes to high.   |
| MODE        | 5          | Mode Selection pin. Connect to logic high or input voltage VIN for PFM mode; connect to logic low or ground for forced PWM mode. Do not leave this pin floating.   |
| RSI         | 6          | This input resets the 1ms timer. When the output voltage is within the PGOOD window, an internal timer is started and generates a PG signal 1ms later when RSI is low. A high RSI resets PG and RSI high to low transition restarts the internal counter if the output voltage is within the window, otherwise the counter is reset by the output voltage condition. |
| VFB         | 7          | Buck regulator output feedback. Connect to the output through a resistor divider for adjustable output voltage (ISL8012-ADJ). For preset output voltage, connect this pin to the output.   |
| SGND        | 8          | System ground for the control logic. All voltage levels are measured with respect to this pin.   |
| PGND        | 9          | Ground connect for the IC and thermal relief for the package. The exposed pad must be connected to PGND and soldered to the PCB.   |
| LX          | 10         | Switching node connection. Connect to one terminal of inductor.  |
| Exposed Pad | PD         | The exposed pad must be connected to the PGND and SGND pin for proper electrical performance. The exposed pad must also be connected to as much as possible for optimal thermal performance.   |

# Typical Application

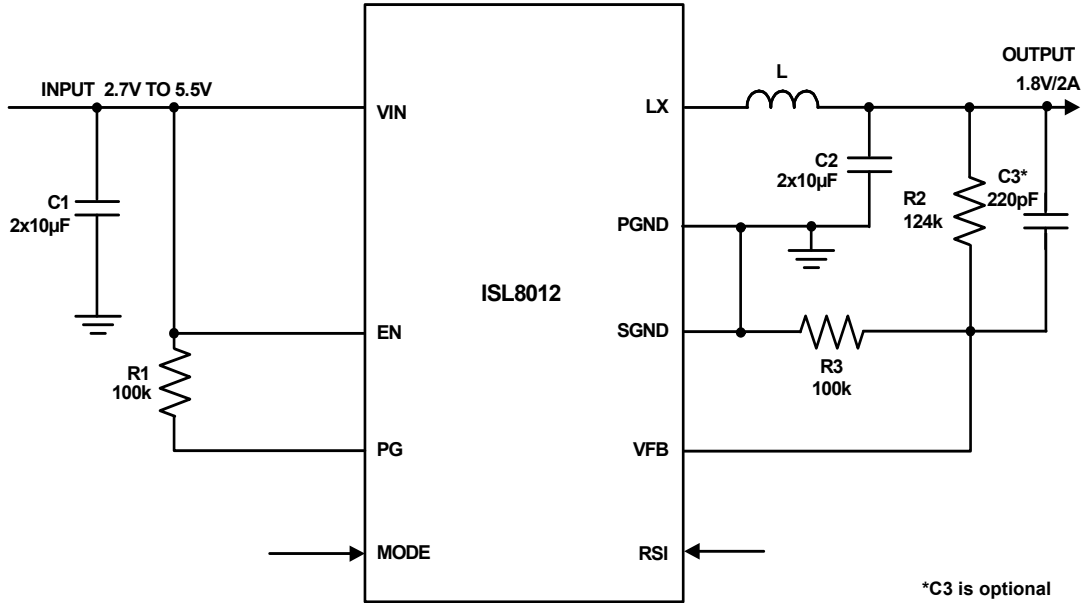

FIGURE 1. TYPICAL APPLICATION DIAGRAM

# Block Diagram

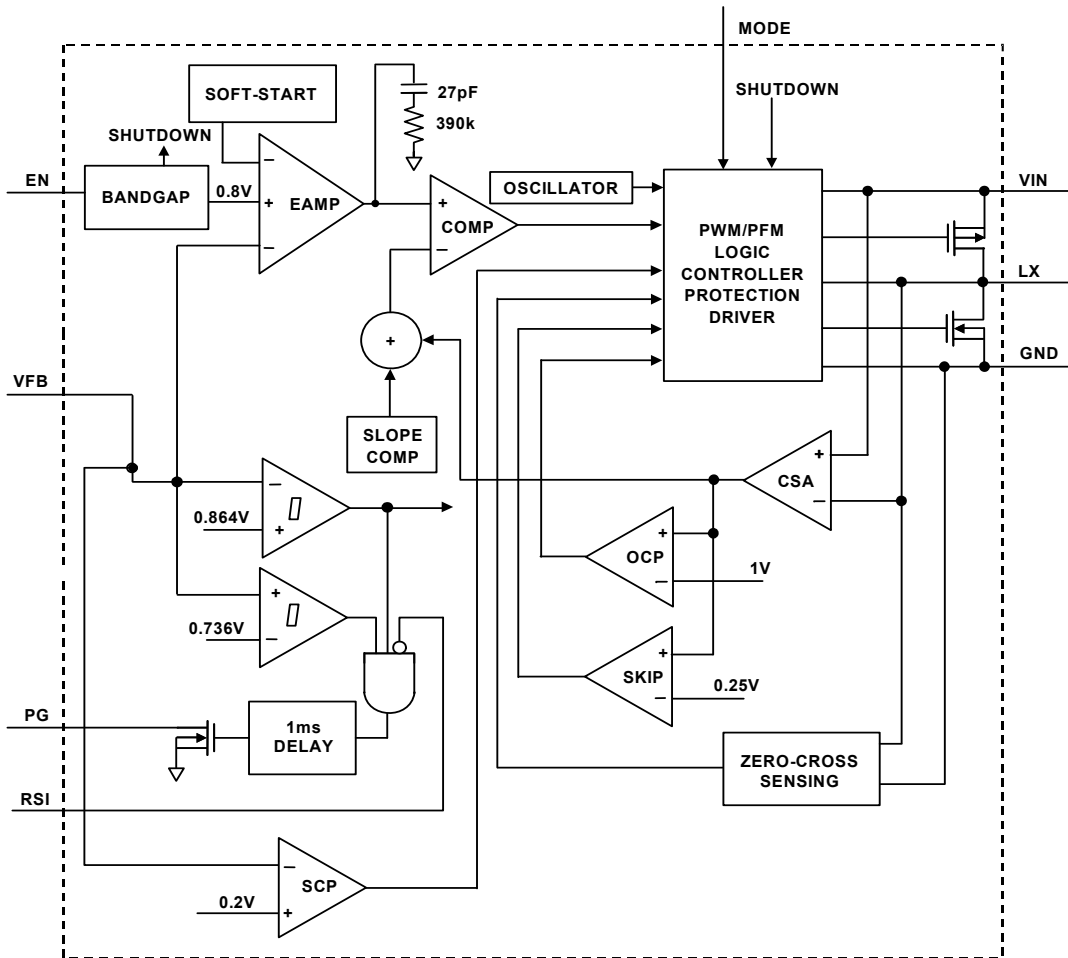

FIGURE 2. FUNCTIONAL BLOCK DIAGRAM

---

## Ordering Information

| PART NUMBER<br>(Notes 1, 2, 3) | PART<br>MARKING | TEMP. RANGE<br>(°C) | PACKAGE<br>(Pb-Free) | PKG.<br>DWG. # |
|--------------------------------|-----------------|---------------------|----------------------|----------------|
| ISL8012IRZ                     | 012Z            | -40 to +85          | 10 Ld 3x3 DFN        | L10.3x3C       |

**NOTES:**

1. Add "-T\*" or suffix for tape and reel. Please refer to [TB347](#) for details on reel specifications.
2. These Intersil Pb-free plastic packaged products employ special Pb-free material sets, molding compounds/die attach materials, and 100% matte tin plate plus anneal (e3 termination finish, which is RoHS compliant and compatible with both SnPb and Pb-free soldering operations). Intersil Pb-free products are MSL classified at Pb-free peak reflow temperatures that meet or exceed the Pb-free requirements of IPC/JEDEC J STD-020.
3. For Moisture Sensitivity Level (MSL), please see device information page for [ISL8012](#). For more information on MSL please see techbrief [TB363](#).

**Absolute Maximum Ratings** (Reference to GND)

|                       |                                  |
|-----------------------|----------------------------------|
| V <sub>IN</sub> , VCC | -0.3V to 6V                      |
| EN, RSI, PG           | -0.3V to V <sub>IN</sub> +0.3V   |
| LX                    | -1.5V (100ns)/-0.3V (DC) to 6.5V |
| VFB                   | -0.3V to 2.7V                    |

**Recommended Operating Conditions**

|                                      |                  |
|--------------------------------------|------------------|
| V <sub>IN</sub> Supply Voltage Range | 2.7V to 5.5V     |
| Load Current Range                   | 0A to 2A         |
| Ambient Temperature Range            | -40 °C to +85 °C |
| ESD Rating                           |                  |
| Human Body Model                     | 5kV              |
| Machine Model                        | 300V             |

**Thermal Information**

|                              |   |                      |
|------------------------------|---|----------------------|
| Thermal Resistance (Typical) | $\theta_{JA}$ (°C/W)  | $\theta_{JC}$ (°C/W) |
| 10 Ld 3x3 DFN (Notes 4, 5)   | 49  | 5.5                  |
| Junction Temperature Range   | -55 °C to +125 °C   |                      |
| Storage Temperature Range    | -65 °C to +150 °C   |                      |
| Pb-Free Reflow Profile       | see link below  |                      |
|                              | <a href="http://www.intersil.com/pbfree/Pb-FreeReflow.asp">http://www.intersil.com/pbfree/Pb-FreeReflow.asp</a> |                      |

**CAUTION:** Do not operate at or near the maximum ratings listed for extended periods of time. Exposure to such conditions may adversely impact product reliability and result in failures not covered by warranty.

**NOTES:**

- $\theta_{JA}$  is measured in free air with the component mounted on a high effective thermal conductivity test board with "direct attach" features. See Tech Brief [TB379](#).
- For  $\theta_{JC}$ , the "case temp" location is the center of the exposed metal pad on the package underside.

**Electrical Specifications** Unless otherwise noted, all parameter limits are established over the recommended operating conditions and the typical specifications are measured at the following conditions: T<sub>A</sub> = -40 °C to +85 °C, V<sub>IN</sub> = 3.6V, EN = VCC, unless otherwise noted. Typical values are at T<sub>A</sub> = +25 °C. **Boldface limits apply over the operating temperature range, -40 °C to +85 °C.**

| PARAMETER                           | SYMBOL            | TEST CONDITIONS  | MIN (Note 7) | TYP  | MAX (Note 7) | UNITS |
|-------------------------------------|-------------------|--|--------------|------|--------------|-------|
| <b>INPUT SUPPLY</b>                 |                   |  |              |      |              |       |
| VIN Undervoltage Lockout Threshold  | V <sub>UVLO</sub> | Rising   |              | 2.5  | <b>2.7</b>   | V     |
|                                     |                   | Falling  | <b>2.2</b>   | 2.4  |              | V     |
| Quiescent Supply Current            | I <sub>VIN</sub>  | MODE = VIN, no load at the output  |              | 40   | <b>60</b>    | μA    |
|                                     |                   | MODE = VIN, no load at the output and no switches switching; design info only            |              | 15   |              | μA    |
|                                     |                   | MODE = SGND, no load at the output   |              | 6    | <b>8</b>     | mA    |
| Shut Down Supply Current            | I <sub>SD</sub>   | V <sub>IN</sub> = 5.5V, EN = low   |              | 0.1  | <b>2</b>     | μA    |
| <b>OUTPUT REGULATION</b>            |                   |  |              |      |              |       |
| VFB Regulation Voltage              | V <sub>VFB</sub>  | T <sub>A</sub> = 0 °C to +85 °C  | 0.784        | 0.8  | 0.816        | V     |
| VFB Bias Current                    | I <sub>VFB</sub>  | VFB = 0.75V  |              | 0.1  |              | μA    |
| Output Voltage Accuracy             |                   | V <sub>IN</sub> = V <sub>O</sub> + 0.5V to 5.5V, I <sub>O</sub> = 0A to 2A (Note 6)      | <b>-3</b>    |      | <b>3</b>     | %     |
| Line Regulation                     |                   | V <sub>IN</sub> = V <sub>O</sub> + 0.5V to 5.5V (minimal 2.7V), I <sub>OUT</sub> = 400mA |              | 0.2  |              | %/V   |
| <b>COMPENSATION</b>                 |                   |  |              |      |              |       |
| Error Amplifier Trans-Conductance   |                   | Adjustable version, design info only   |              | 20   |              | μA/V  |
| <b>LX</b>                           |                   |  |              |      |              |       |
| P-Channel MOSFET ON-Resistance      |                   | V <sub>IN</sub> = 5.5V, I <sub>O</sub> = 200mA   |              | 0.12 | <b>0.22</b>  | Ω     |
|                                     |                   | V <sub>IN</sub> = 2.7V, I <sub>O</sub> = 200mA   |              | 0.21 | <b>0.27</b>  | Ω     |
| N-Channel MOSFET ON-Resistance      |                   | V <sub>IN</sub> = 5.5V, I <sub>O</sub> = 200mA   |              | 0.11 | <b>0.22</b>  | Ω     |
|                                     |                   | V <sub>IN</sub> = 2.7V, I <sub>O</sub> = 200mA   |              | 0.13 | <b>0.27</b>  | Ω     |
| P-Channel MOSFET Peak Current Limit | I <sub>PK</sub>   |  | <b>2.65</b>  | 3.00 | <b>3.50</b>  | A     |
| LX Maximum Duty Cycle               |                   |  |              | 100  |              | %     |
| PWM Switching Frequency             | f <sub>S</sub>    | T <sub>A</sub> = 0 °C to +85 °C  | 0.840        | 1    | 1.16         | MHz   |

**Electrical Specifications** Unless otherwise noted, all parameter limits are established over the recommended operating conditions and the typical specifications are measured at the following conditions:  $T_A = -40^\circ\text{C}$  to  $+85^\circ\text{C}$ ,  $V_{IN} = 3.6\text{V}$ ,  $\text{EN} = \text{VCC}$ , unless otherwise noted. Typical values are at  $T_A = +25^\circ\text{C}$ . **Boldface limits apply over the operating temperature range,  $-40^\circ\text{C}$  to  $+85^\circ\text{C}$ .** (Continued)

| PARAMETER                                  | SYMBOL | TEST CONDITIONS                          | MIN<br>(Note 7) | TYP  | MAX<br>(Note 7) | UNITS         |
|--|--------|--|-----------------|------|-----------------|---------------|
| LX Minimum On-Time                         |        | MODE = low (forced PWM mode)             |                 | 80   | <b>100</b>      | ns            |
| Soft-Start-Up Time                         |        | $V_{IN} = 3.6\text{V}$                   |                 | 1.1  |                 | ms            |
| <b>PG</b>                                  |        |  |                 |      |                 |               |
| Output Low Voltage                         |        | Sinking 1mA, $V_{FB} = 0.7\text{V}$      |                 |      | <b>0.3</b>      | V             |
| Delay Time                                 |        |  |                 | 1    |                 | ms            |
| PG Pin Leakage Current                     |        | $\text{PG} = V_{IN} = 3.6\text{V}$       |                 | 0.01 | <b>0.1</b>      | $\mu\text{A}$ |
| Minimum Supply Voltage for Valid PG Signal |        |  | <b>1.2</b>      |      |                 | V             |
| Internal PGOOD Low Rising Threshold        |        | Percentage of nominal regulation voltage | <b>89</b>       | 92   | <b>95</b>       | %             |
| Internal PGOOD Low Falling Threshold       |        | Percentage of nominal regulation voltage | <b>85</b>       | 88   | <b>91</b>       | %             |
| Internal PGOOD High Rising Threshold       |        | Percentage of nominal regulation voltage | <b>107</b>      | 110  | <b>113</b>      | %             |
| Internal PGOOD High Falling Threshold      |        | Percentage of nominal regulation voltage | <b>104</b>      | 107  | <b>110</b>      | %             |
| Internal PGOOD Delay Time                  |        |  |                 | 30   |                 | $\mu\text{s}$ |
| <b>EN, MODE, RSI</b>                       |        |  |                 |      |                 |               |
| Logic Input Low                            |        |  |                 |      | <b>0.4</b>      | V             |
| Logic Input High                           |        |  | <b>1.4</b>      |      |                 | V             |
| Logic Input Leakage Current                |        | Pulled up to 5.5V                        |                 | 0.1  | <b>1</b>        | $\mu\text{A}$ |

## NOTES:

- Limits established by characterization and are not production tested.
- Parameters with MIN and/or MAX limits are 100% tested at  $+25^\circ\text{C}$ , unless otherwise specified. Temperature limits established by characterization and are not production tested.

**Typical Operating Performance** (Unless otherwise noted, operating conditions are:  $T_A = +25^\circ\text{C}$ ,  $V_{IN} = 2.5\text{V}$  to  $5.5\text{V}$ ,  $E_N = V_{IN}$ ,  $\text{MODE} = \text{OV}$ ,  $L = 2.2\mu\text{H}$ ,  $C_1 = 2 \times 10\mu\text{F}$ ,  $C_2 = 2 \times 10\mu\text{F}$ ,  $I_{OUT} = 0\text{A}$  to  $2\text{A}$ ).

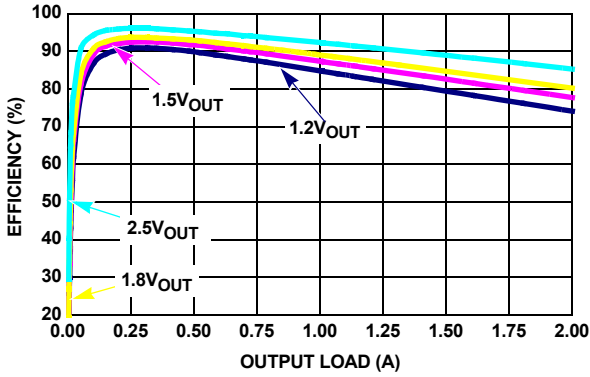

FIGURE 3. EFFICIENCY vs LOAD (1MHz 3.3VIN PWM)

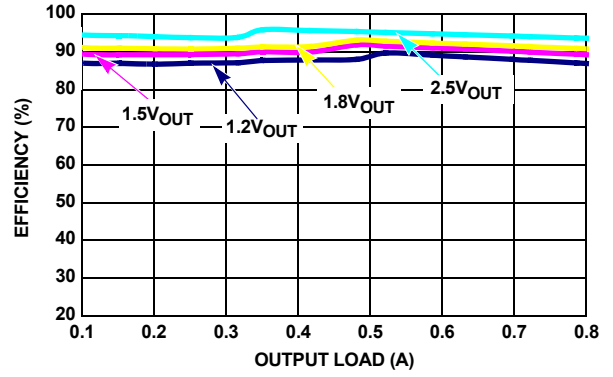

FIGURE 4. EFFICIENCY vs LOAD (1MHz 3.3VIN PFM)

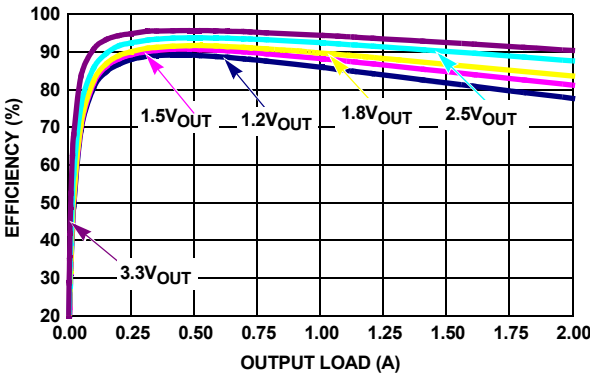

FIGURE 5. EFFICIENCY vs LOAD (1MHz 5VIN PWM)

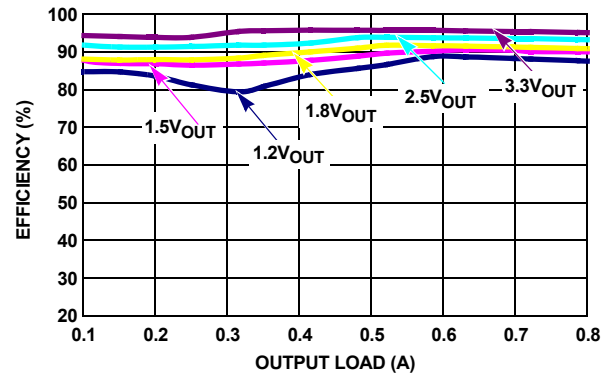

FIGURE 6. EFFICIENCY vs LOAD (1MHz 5VIN PFM)

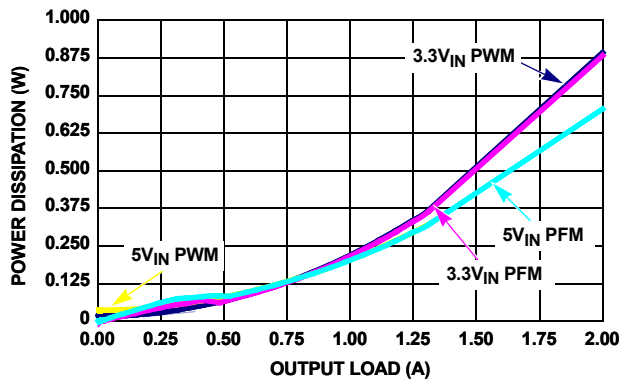

FIGURE 7. POWER DISSIPATION vs LOAD (1MHz,  $V_{OUT} = 1.8\text{V}$ )

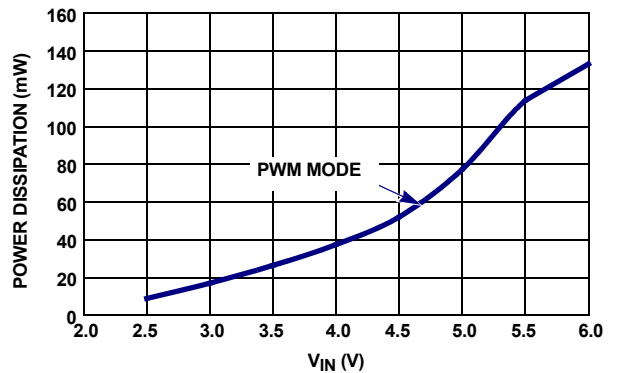

FIGURE 8. POWER DISSIPATION WITH NO LOAD vs  $V_{IN}$  (PWM  $V_{OUT} = 1.8\text{V}$ )

## Typical Operating Performance

(Unless otherwise noted, operating conditions are:  $T_A = +25^\circ\text{C}$ ,  $V_{VIN} = 2.5\text{V to } 5.5\text{V}$ ,  $EN = V_{IN}$ ,  $MODE = 0V$ ,  $L = 2.2\mu\text{H}$ ,  $C_1 = 2 \times 10\mu\text{F}$ ,  $C_2 = 2 \times 10\mu\text{F}$ ,  $I_{OUT} = 0\text{A to } 2\text{A}$ ). (Continued)

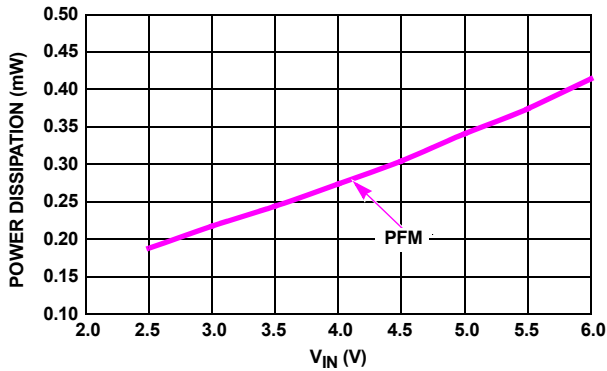

FIGURE 9. POWER DISSIPATION WITH NO LOAD vs  $V_{IN}$  (PFM  $V_{OUT} = 1.8\text{V}$ )

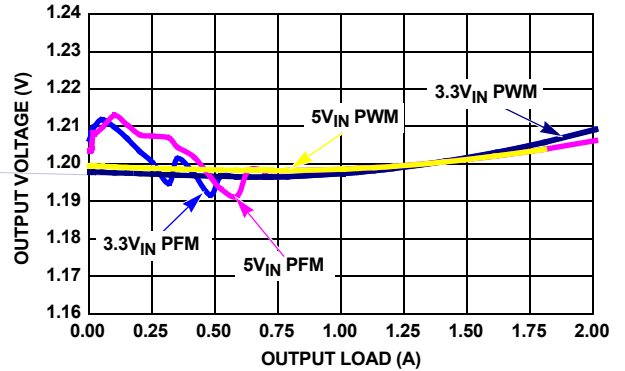

FIGURE 10.  $V_{OUT}$  REGULATION vs LOAD (1MHz,  $V_{OUT} = 1.2\text{V}$ )

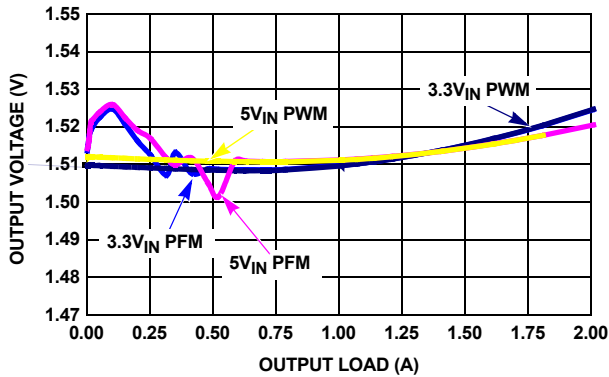

FIGURE 11.  $V_{OUT}$  REGULATION vs LOAD (1MHz,  $V_{OUT} = 1.5\text{V}$ )

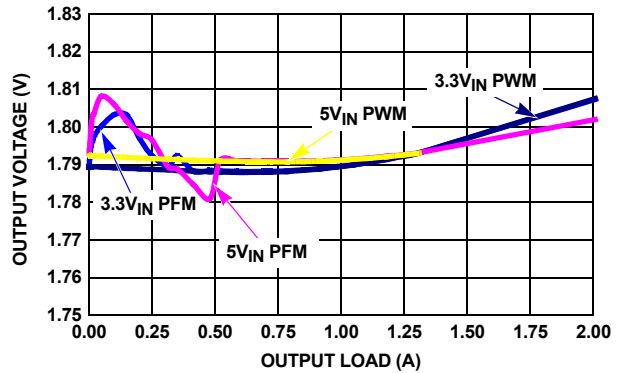

FIGURE 12.  $V_{OUT}$  REGULATION vs LOAD (1MHz,  $V_{OUT} = 1.8\text{V}$ )

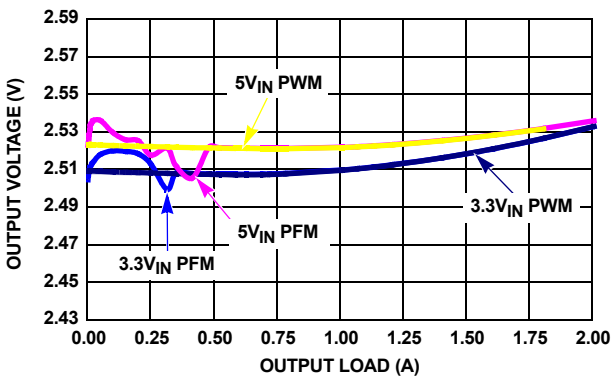

FIGURE 13.  $V_{OUT}$  REGULATION vs LOAD (1MHz,  $V_{OUT} = 2.5\text{V}$ )

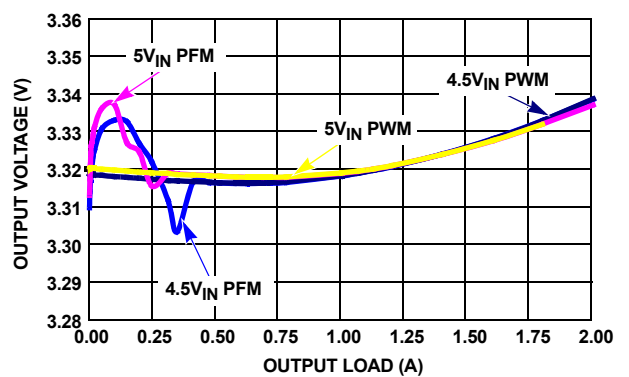

FIGURE 14.  $V_{OUT}$  REGULATION vs LOAD (1MHz,  $V_{OUT} = 3.3\text{V}$ )



## Typical Operating Performance

(Unless otherwise noted, operating conditions are:  $T_A = +25^\circ\text{C}$ ,  $V_{VIN} = 2.5\text{V to } 5.5\text{V}$ ,  $EN = V_{IN}$ ,  $MODE = 0\text{V}$ ,  $L = 2.2\mu\text{H}$ ,  $C_1 = 2 \times 10\mu\text{F}$ ,  $C_2 = 2 \times 10\mu\text{F}$ ,  $I_{OUT} = 0\text{A to } 2\text{A}$ ). (Continued)

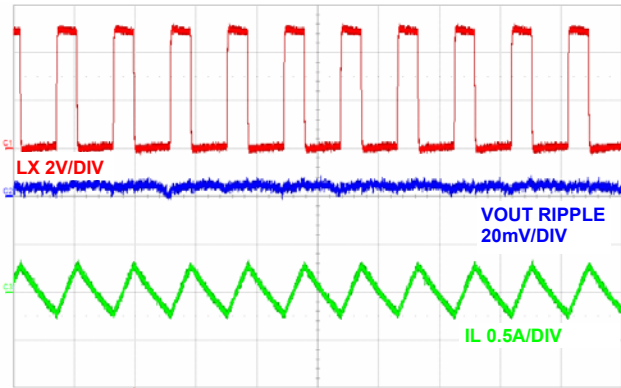

FIGURE 15. STEADY STATE OPERATION AT NO LOAD (PWM), (1µs/DIV)

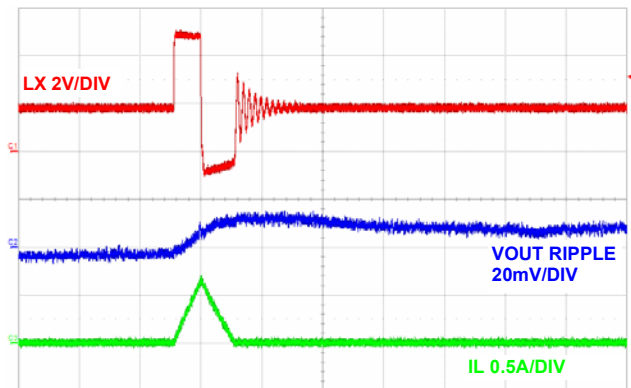

FIGURE 16. STEADY STATE OPERATION AT NO LOAD (PFM), (1µs/DIV)

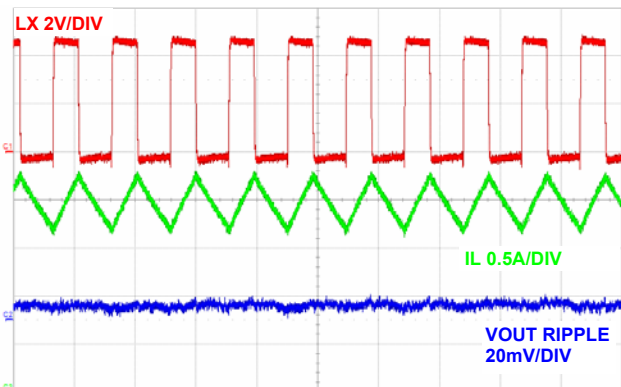

FIGURE 17. STEADY STATE OPERATION WITH FULL LOAD, (5µs/DIV)

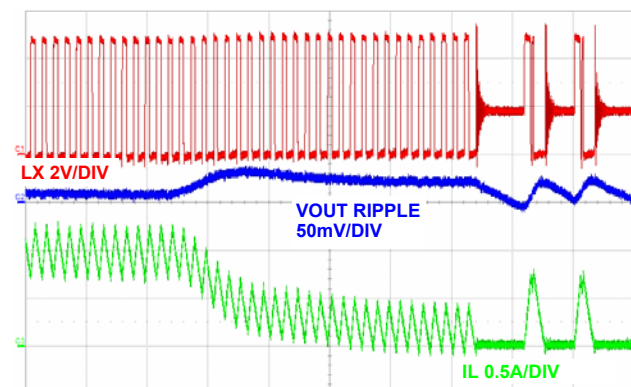

FIGURE 18. MODE TRANSITION CCM TO DCM, (5µs/DIV)

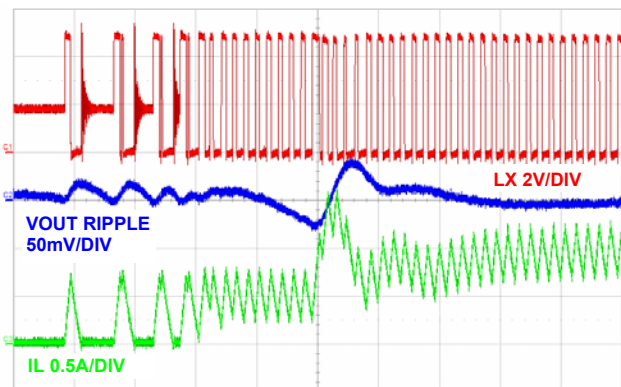

FIGURE 19. MODE TRANSITION DCM TO CCM, (50µs/DIV)

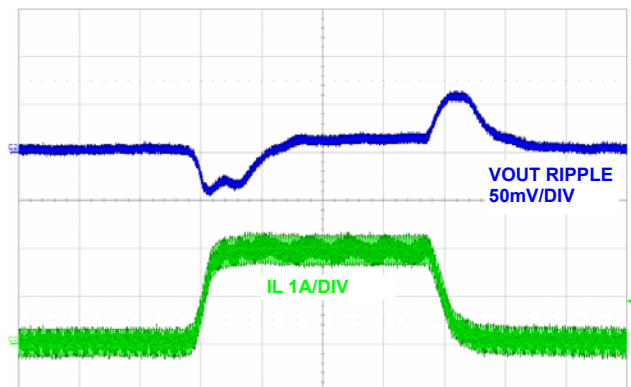

FIGURE 20. LOAD TRANSIENT (PWM), (50µs/DIV)

## Typical Operating Performance

(Unless otherwise noted, operating conditions are:  $T_A = +25^\circ\text{C}$ ,  $V_{VIN} = 2.5\text{V}$  to  $5.5\text{V}$ ,  $EN = V_{IN}$ ,  $MODE = 0\text{V}$ ,  $L = 2.2\mu\text{H}$ ,  $C_1 = 2 \times 10\mu\text{F}$ ,  $C_2 = 2 \times 10\mu\text{F}$ ,  $I_{OUT} = 0\text{A}$  to  $2\text{A}$ ). (Continued)

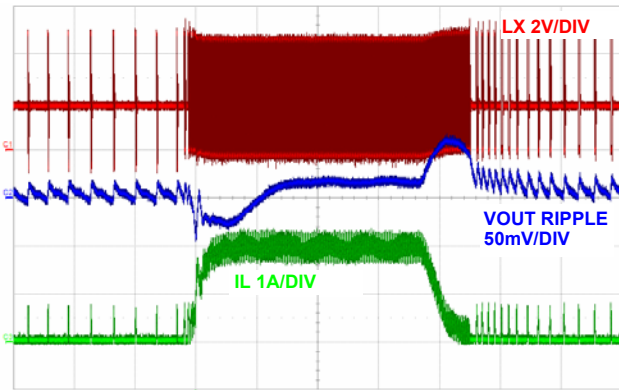

FIGURE 21. LOAD TRANSIENT (PFM), (500µs/DIV)

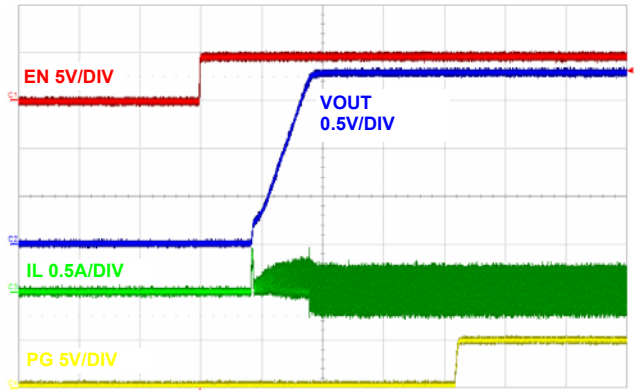

FIGURE 22. SOFT-START WITH NO LOAD (PWM), (500µs/DIV)

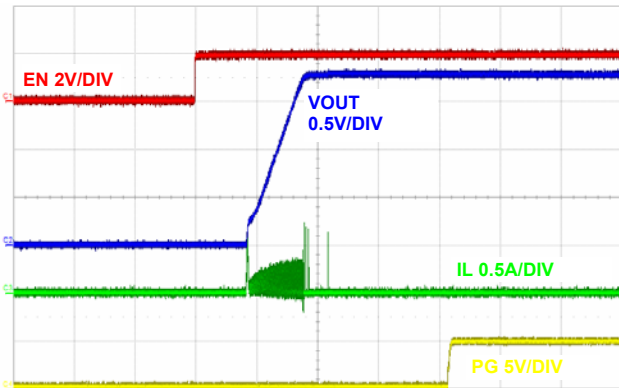

FIGURE 23. SOFT-START AT NO LOAD (PFM), (500µs/DIV)

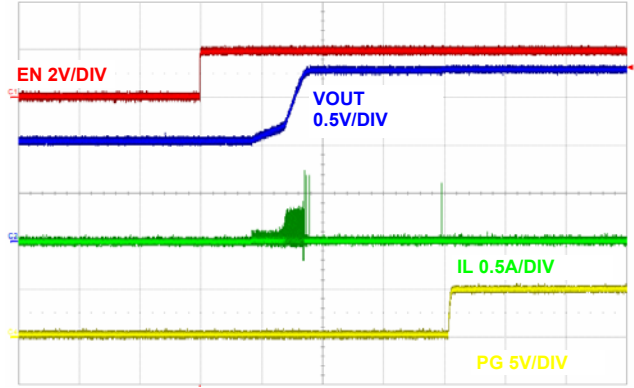

FIGURE 24. SOFT-START WITH PRE-BIASED 1V, (500µs/DIV)

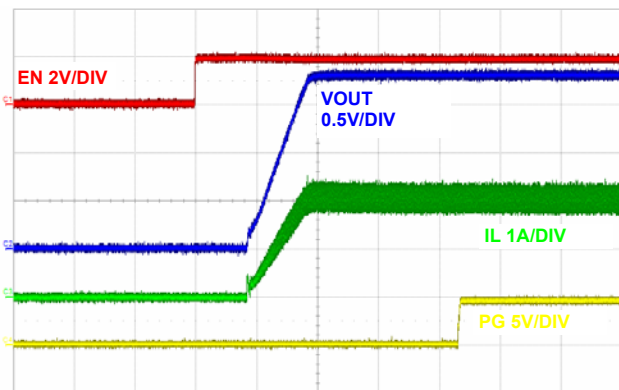

FIGURE 25. SOFT-START AT FULL LOAD, (2ms/DIV)

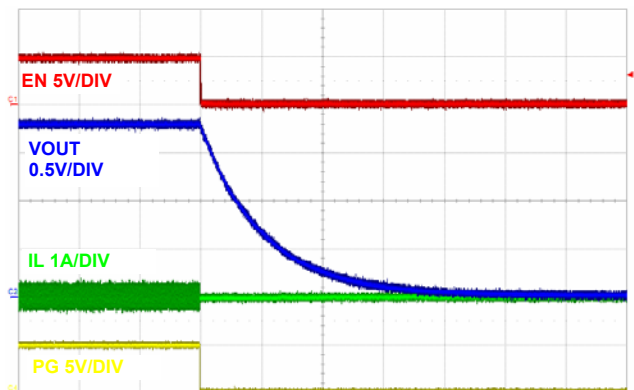

FIGURE 26. SOFT-DISCHARGE SHUTDOWN, (2ms/DIV)

# Typical Operating Performance

(Unless otherwise noted, operating conditions are:  $T_A = +25^\circ\text{C}$ ,  $V_{VIN} = 2.5\text{V to } 5.5\text{V}$ ,  $EN = V_{IN}$ ,  $MODE = 0\text{V}$ ,  $L = 2.2\mu\text{H}$ ,  $C_1 = 2 \times 10\mu\text{F}$ ,  $C_2 = 2 \times 10\mu\text{F}$ ,  $I_{OUT} = 0\text{A to } 2\text{A}$ ). (Continued)

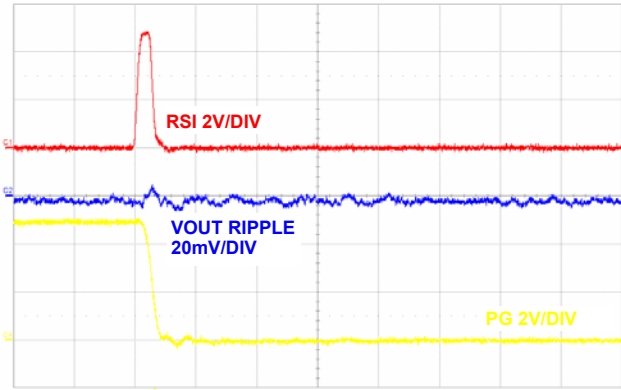

FIGURE 27. RSI RESET, (200 $\mu\text{s}$ /DIV)

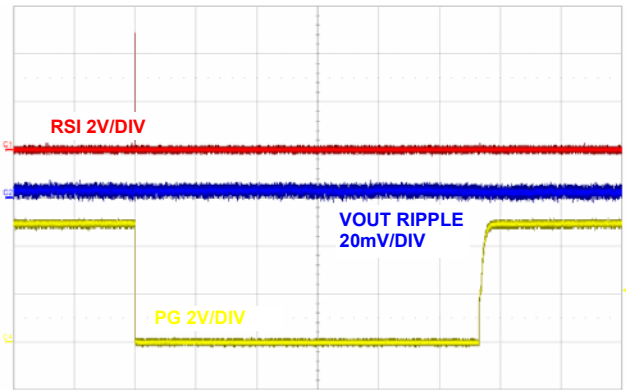

FIGURE 28. RSI RESET (ZOOM OUT), (200 $\mu\text{s}$ /DIV)

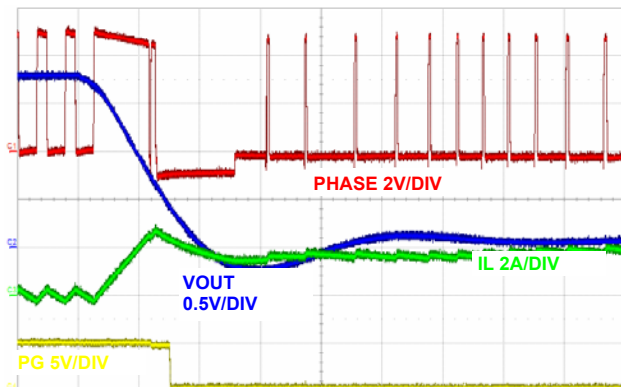

FIGURE 29. OUTPUT SHORT CIRCUIT, (500 $\mu\text{s}$ /DIV)

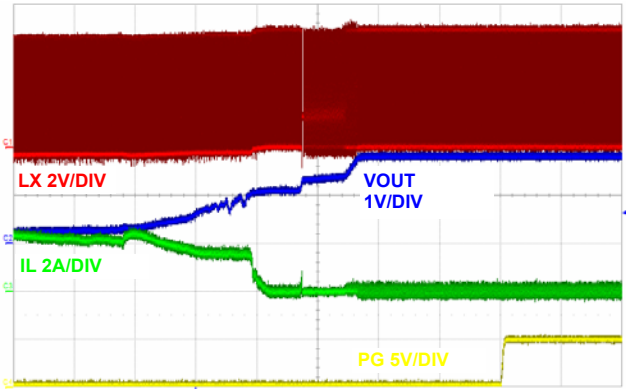

FIGURE 30. OUTPUT SHORT CIRCUIT RECOVERY, (500 $\mu\text{s}$ /DIV)

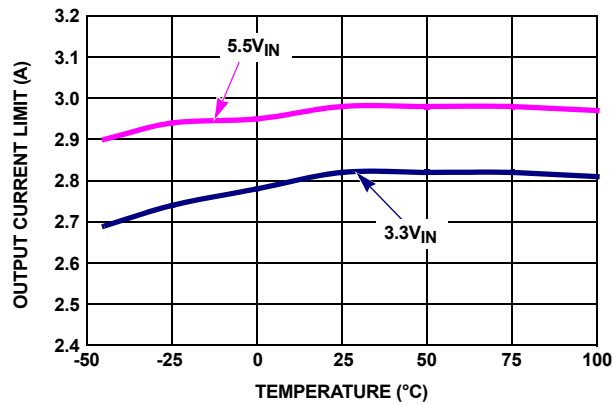

FIGURE 31. OUTPUT CURRENT LIMIT vs TEMPERATURE

## Theory of Operation

The ISL8012 is a step-down switching regulator optimized for battery-powered handheld applications. The regulator operates at 1MHz fixed switching frequency under heavy load conditions to allow smaller external inductors and capacitors to be used for minimal printed-circuit board (PCB) area. At light load, the regulator reduces the switching frequency (unless forced to the fixed frequency) to minimize the switching loss and to maximize the battery life. The quiescent current when the output is not loaded is typically only 40µA. The supply current is typically only 0.1µA when the regulator is shut down.

### PWM Control Scheme

Pulling the MODE pin LOW (<0.4V) forces the converter into PWM mode, regardless of output current. The ISL8012 employs the current-mode pulse-width modulation (PWM) control scheme for fast transient response and pulse-by-pulse current limiting. Figure 2 shows the block diagram. The current loop consists of the oscillator, the PWM comparator, current sensing circuit and the slope compensation for the current loop stability. The gain for the current sensing circuit is typically 285mV/A. The control reference for the current loops comes from the error amplifier's (EAMP) output.

The PWM operation is initialized by the clock from the oscillator. The P-Channel MOSFET is turned on at the beginning of a PWM cycle and the current in the MOSFET starts to ramp-up. When the sum of the current amplifier CSA and the slope compensation (675mV/µs) reaches the control reference of the current loop, the PWM comparator COMP sends a signal to the PWM logic to turn off the P-MOSFET and turn on the N-Channel MOSFET. The N-MOSFET stays on until the end of the PWM cycle. Figure 32 shows the typical operating waveforms during the PWM operation. The dotted lines illustrate the sum of the slope compensation ramp and the current-sense amplifier's CSA output.

The output voltage is regulated by controlling the  $V_{EAMP}$  voltage to the current loop. The bandgap circuit outputs a 0.8V reference voltage to the voltage loop. The feedback signal comes from the VFB pin. The soft-start block only affects the operation during the start-up and will be discussed separately. The error amplifier is a transconductance amplifier that converts the voltage error signal to a current output. The voltage loop is internally compensated with the 27pF and 390kΩ RC network. The maximum EAMP voltage output is precisely clamped to 1.47V.

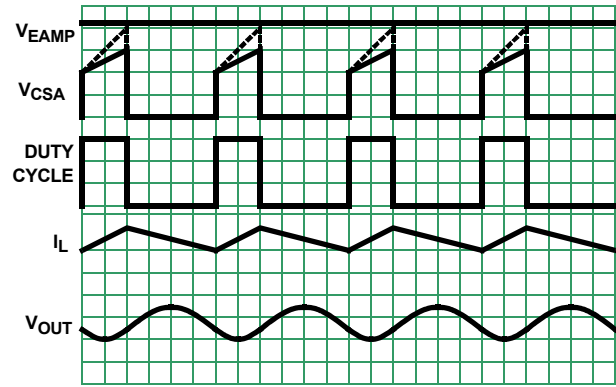

FIGURE 32. PWM OPERATION WAVEFORMS

### SKIP Mode

Pulling the MODE pin HIGH (>1.4V) forces the converter into PFM mode. The ISL8012 enters a pulse-skipping mode at light load to minimize the switching loss by reducing the switching frequency. Figure 33 illustrates the skip-mode operation. A zero-cross sensing circuit shown in Figure 2 monitors the N-MOSFET current for zero crossing. When 8 consecutive cycles of the inductor current crossing zero are detected, the regulator enters the skip mode. During the 8 detecting cycles, the current in the inductor is allowed to become negative. The counter is reset to zero when the current in any cycle does not cross zero.

Once the skip mode is entered, the pulse modulation starts being controlled by the SKIP comparator shown in Figure 2. Each pulse cycle is still synchronized by the PWM clock. The P-MOSFET is turned on at the clock's rising edge and turned off when the output is higher than 1.5% of the nominal regulation or when its current reaches the peak Skip current limit value. Then the inductor current is discharging to zero Ampere and stays at zero. The internal clock is disabled. The output voltage reduces gradually due to the load current discharging the output capacitor. When the output voltage drops to the nominal voltage, the P-MOSFET will be turned on again at the rising edge of the internal clock as it repeats the previous operations.

The regulator resumes normal PWM mode operation when the output voltage drops 1.5% below the nominal voltage.

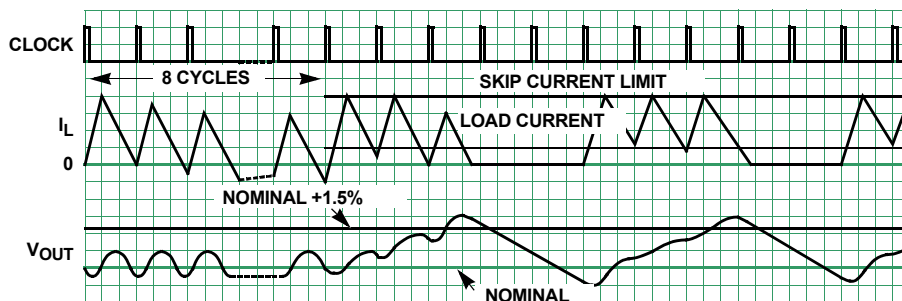

FIGURE 33. SKIP MODE OPERATION WAVEFORMS

## Mode Control

The ISL8012 has a MODE pin that controls the operation mode. When the MODE pin is driven to low or shorted to ground, the regulator operates in a forced PWM mode. The forced PWM mode remains the fixed PWM frequency at light load instead of entering the skip mode.

## Overcurrent Protection

The overcurrent protection is realized by monitoring the CSA output with the OCP comparator, as shown in Figure 2. The current sensing circuit has a gain of 285mV/A, from the P-MOSFET current to the CSA output. When the CSA output reaches 1V, which is equivalent to 2.9A for the switch current (0.15V offset), the OCP comparator is tripped to turn off the P-MOSFET immediately. The overcurrent function protects the switching converter from a shorted output by monitoring the current flowing through the upper MOSFET.

Upon detection of overcurrent condition, the upper MOSFET will be immediately turned off and will not be turned on again until the next switching cycle.

## Short-Circuit Protection

The short-circuit protection SCP comparator monitors the VFB pin voltage for output short-circuit protection. When the VFB is lower than 0.2V, the SCP comparator forces the PWM oscillator frequency to drop to minimum value to reduce the power dissipation. This comparator is effective during start-up or an output short-circuit event.

## RSI/PG Function

When powering up, the open-collector Power-Good output holds low for about 1ms after  $V_O$  reaches the preset voltage. When the active-HI reset signal RSI is issued, PG goes to low immediately and holds for the same period of time after RSI comes back to LOW. The output voltage is unaffected. Please refer to the timing diagram in Figure 34. When the function is not used, connect RSI to ground and leave the pull-up resistor  $R_4$  open at the PG pin.

The PG output also serves as a 1ms delayed Power-Good signal when the pull-up resistor  $R_1$  is installed. The RSI pin needs to be directly (or indirectly through a resistor) connected to Ground for PG to be actively monitoring the output voltage.

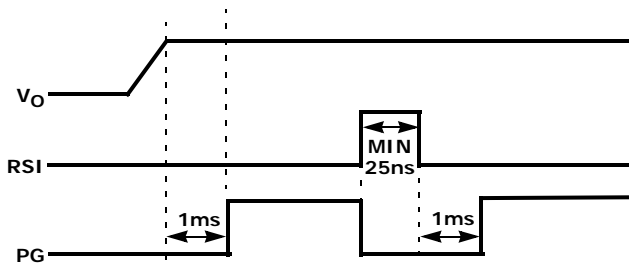

FIGURE 34. RSI AND PG TIMING DIAGRAM

## UVLO

When the input voltage is below the undervoltage lock-out (UVLO) threshold, the regulator is disabled.

## Soft Start-Up

The soft-start-up reduces the in-rush current during the start-up. The soft-start block outputs a ramp reference to the input of the error amplifier. This voltage ramp limits the inductor current as well as the output voltage speed so that the output voltage rises in a controlled fashion. When VFB is less than 0.2V at the beginning of the soft-start, the switching frequency is reduced to 1/3 of the nominal value so that the output can start up smoothly at light load condition. During soft-start, the IC operates in the SKIP mode to support pre-biased output condition.

## Enable

The enable (EN) input allows the user to control the turning on or off the regulator for purposes such as power-up sequencing. When the regulator is enabled, there is typically a 600μs delay for waking up the bandgap reference and then the soft-start-up begins.

## Discharge Mode (Soft-Stop)

When a transition to shutdown mode occurs or the VIN UVLO is set, the outputs discharge to GND through an internal 100Ω switch.

## Power MOSFETs

The power MOSFETs are optimized for best efficiency. The ON-resistance for the P-MOSFET is typically 120mΩ and the ON-resistance for the N-MOSFET is typically 110mΩ.

## 100% Duty Cycle

The ISL8012 features 100% duty cycle operation to maximize the battery life. When the battery voltage drops to a level that the ISL8012 can no longer maintain the regulation at the output, the regulator completely turns on the P-MOSFET. The maximum dropout voltage under the 100% duty-cycle operation is the product of the load current and the ON-resistance of the P-MOSFET.

## Thermal Shut-Down

The ISL8012 has built-in thermal protection. When the internal temperature reaches +140°C, the regulator is completely shut down. As the temperature drops to +115°C, the ISL8012 resumes operation by stepping through the soft-start.

## Applications Information

### Output Inductor and Capacitor Selection

To consider steady state and transient operations, ISL8012 typically uses a 2.2μH output inductor. The higher or lower inductor value can be used to optimize the total converter system performance. For example, for higher output voltage 3.3V application, in order to decrease the inductor current ripple and output voltage ripple, the output inductor value can be increased. It is recommended to set the ripple inductor current approximately 30% of the maximum output current for optimized

performance. The inductor ripple current can be expressed as shown in Equation 1:

$$\Delta I = \frac{V_O \cdot \left(1 - \frac{V_O}{V_{IN}}\right)}{L \cdot f_S} \quad (\text{EQ. 1})$$

The inductor's saturation current rating needs to be at least larger than the peak current. The ISL8012 protects the typical peak current 3A. The saturation current needs to be over 4A for maximum output current application.

ISL8012 uses an internal compensation network and the output capacitor value is dependent on the output voltage. The ceramic capacitor is recommended to be X5R or X7R. The recommended X5R or X7R minimum output capacitor values are shown in Table 1.

TABLE 1. OUTPUT CAPACITOR VALUE vs  $V_{OUT}$

| $V_{OUT}$<br>(V) | $C_{OUT}$<br>( $\mu\text{F}$ ) | L<br>( $\mu\text{H}$ ) |
|------------------|--------------------------------|------------------------|
| 0.8              | 2x10                           | 1.5~3.3                |
| 1.2              | 2x10                           | 1.5~3.3                |
| 1.5              | 2x10                           | 1.8~3.3                |
| 1.8              | 2x10                           | 2.2~3.3                |
| 2.5              | 2x10                           | 2.2~4.7                |
| 3.3              | 2x10                           | 2.2~4.7                |
| 3.6              | 2x10                           | 2.2~4.7                |

In Table 1, the minimum output capacitor value is given for the different output voltage to make sure that the whole converter system is stable. The maximum output capacitor should be limited to 50 $\mu\text{F}$  or less.

## Output Voltage Selection

The output voltage of the regulator can be programmed via an external resistor divider that is used to scale the output voltage relative to the internal reference voltage and feed it back to the inverting input of the error amplifier. Refer to Figure 1.

The output voltage programming resistor,  $R_3$ , will depend on the value chosen for the feedback resistor and the desired output voltage of the regulator. The value for the feedback resistor is typically between 10k $\Omega$  and 100k $\Omega$ , as shown in Equation 2.

$$R_3 = \frac{R_2 \times 0.8V}{V_{OUT} - 0.8V} \quad (\text{EQ. 2})$$

If the output voltage desired is 0.8V, then  $R_3$  is left unpopulated and  $R_2$  is shorted. For better performance, add 220pF in parallel with  $R_2$  (124k $\Omega$ ).

## Input Capacitor Selection

The main functions for the input capacitor are to provide decoupling of the parasitic inductance and to provide filtering function to prevent the switching current from flowing back to the battery rail. Two 10 $\mu\text{F}$  X5R or X7R ceramic capacitors are a good starting point for the input capacitor selection.

## Layout Recommendation

The layout is a very important converter design step to make sure the designed converter works well. For the ISL8012 buck converter, the power loop is composed of the output inductor L, the output capacitor  $C_{OUT}$ , LX pin and SGND pin. It is necessary to make the power loop as small as possible.

The heat of the IC is mainly dissipated through the thermal pad. Maximizing the copper area connected to the thermal pad is preferable. In addition, a solid ground plane on the second layer is helpful for EMI performance. Then connect the epad to the ground plane with at least 5 vias for best thermal performance.

## Revision History

The revision history provided is for informational purposes only and is believed to be accurate, but not warranted. Please go to web to make sure you have the latest Rev.

| DATE       | REVISION | CHANGE   |
|------------|----------|--|
| 2011-10-18 | FN6616.2 | <p>Updated Tape &amp; Reel note in "Ordering Information" on page 4 from "Add "-T" suffix for tape and reel." to new standard "Add "-T*" suffix for tape and reel." The "*" covers all possible tape and reel options</p> <p>On page 14, changed "The ISL8012 protects the typical peak current 6A. The saturation current needs be over 7A for maximum output current application." to "The ISL8012 protects the typical peak current 3A. The saturation current needs be over 4A for maximum output current application."</p> <p>Added "The maximum output capacitor should be limited to 50µF or less."</p>   |
| 2010-03-17 | FN6616.1 | <p>Added "Related Literature" to page 1 per new data sheet standards.</p> <p>Moved "Pin Configuration" to page 2 and converted "Pin Descriptions" on page 2 to tabular format, per new data sheet standards.</p> <p>Added inverter symbol on the RSI pin in the "Block Diagram" on page 3.</p> <p>Added ESD ratings to "Absolute Maximum Ratings (Reference to GND)" on page 5 per new data sheet standards.</p> <p>Added "Revision History" on page 15 and "Products" on page 16 per new data sheet standards.</p>  |
| 2009-10-29 |          | <p>On page 2: Redrew chamfered corner on Pinout to look like POD on page 15</p> <p>On page 7 to page 11 in common conditions of "Typical Performance Curves": Changed "L = 1.5µH to 2.2µH" to "L = 2.2µH"</p> <p>"Input Capacitor Selection" on page 14: changed "Two 22µF X5R or X7R ceramic capacitors are a good starting point.." to "Two 10µF X5R or X7R ceramic capacitors are a good starting point.."</p>  |
| 2009-10-27 |          | <p>On page 17: Updated POD to latest revision (changes from Rev 0 to Rev 1 were to add land pattern and move dimensions from table onto drawing)</p> <p>"Typical Application" on page 3: Changed value of C1 &amp; C2 from 22µF to 2x10µF.</p> <p>n page 7 to page 11 in common conditions of "Typical Performance Curves": Changed "L = 1.5µH" to "L = 1.5µH to 2.2µH"</p> <p>On page 14 in Table 1: Changed value of all COUT caps from 22µF to 2x10µF.</p> <p>"Input Capacitor Selection" on page 14: changed "One 22µF X5R or X7R ceramic capacitor is a good starting point.." to "Two 22µF X5R or X7R ceramic capacitors are a good starting point.."</p> <p>Throughout: Converted to new format. Added new required content as follows:</p> <p>On page 4: Added MSL Note 3 to "Ordering Information"</p> <p>On page 5: In the "Electrical Specifications": Adding standard over temp note to common conditions ("Boldface limits apply...") Moved Note 7 "Parameters with MIN and/or MAX limits are 100% tested at +25°C, unless otherwise specified. Temperature limits established by characterization and are not production tested" from common conditions to MIN MAX columns as part of new standard</p> <p>"Thermal Information" on page 5: Updated Theta JC Note 5 from "ThetaJC, "case temperature" location is at the center of the exposed metal pad on the package underside. See Tech Brief TB379." to "For ThetaJC, the "case temp" location is the center of the exposed metal pad on the package underside." per ASYD record and new standards</p> |
| 2009-07-15 |          | <p>On page 2 in Pinout: Deleted the circle and chamfered the corner of thermal pad (to match POD). Re-drew pins 1, 5, 6, 10 to look the same as the other pins</p> <p>Updated Pb-free Note 2 in "Ordering Information" on page 4 based on lead finish, per packaging.</p> <p>On page 5: In the "Electrical Specifications": Removed Note "Parts are 100% tested at +25°C. Temperature limits established by characterization and are not production tested." from MIN MAX columns and replaced with new verbiage in common conditions "Parameters with MIN and/or MAX limits are 100% tested at +25°C, unless otherwise specified. Temperature limits established by characterization and are not production tested."</p>  |
| 2008-03-11 | FN6616.0 | Initial release.   |

---

## Products

Intersil Corporation is a leader in the design and manufacture of high-performance analog semiconductors. The Company's products address some of the industry's fastest growing markets, such as, flat panel displays, cell phones, handheld products, and notebooks. Intersil's product families address power management and analog signal processing functions. Go to [www.intersil.com/products](http://www.intersil.com/products) for a complete list of Intersil product families.

For a complete listing of Applications, Related Documentation and Related Parts, please see the respective device information page on [intersil.com](http://intersil.com): [ISL8012](http://intersil.com/ISL8012)

To report errors or suggestions for this datasheet, please go to [www.intersil.com/askourstaff](http://www.intersil.com/askourstaff)

FITs are available from our website at <http://rel.intersil.com/reports/search.php>

© Copyright Intersil Americas LLC 2008-2011. All Rights Reserved.  
All trademarks and registered trademarks are the property of their respective owners.

For additional products, see [www.intersil.com/en/products.html](http://www.intersil.com/en/products.html)

---

Intersil products are manufactured, assembled and tested utilizing ISO9001 quality systems as noted in the quality certifications found at [www.intersil.com/en/support/qualandreliability.html](http://www.intersil.com/en/support/qualandreliability.html)

---

*Intersil products are sold by description only. Intersil may modify the circuit design and/or specifications of products at any time without notice, provided that such modification does not, in Intersil's sole judgment, affect the form, fit or function of the product. Accordingly, the reader is cautioned to verify that datasheets are current before placing orders. Information furnished by Intersil is believed to be accurate and reliable. However, no responsibility is assumed by Intersil or its subsidiaries for its use; nor for any infringements of patents or other rights of third parties which may result from its use. No license is granted by implication or otherwise under any patent or patent rights of Intersil or its subsidiaries.*

---

For information regarding Intersil Corporation and its products, see [www.intersil.com](http://www.intersil.com)



# Package Outline Drawing

## L10.3x3C

10 LEAD DUAL FLAT PACKAGE (DFN)

Rev 2, 09/09

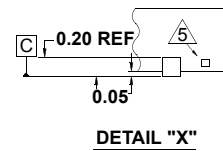
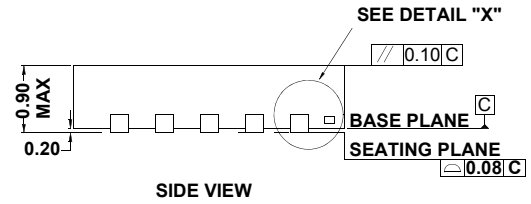
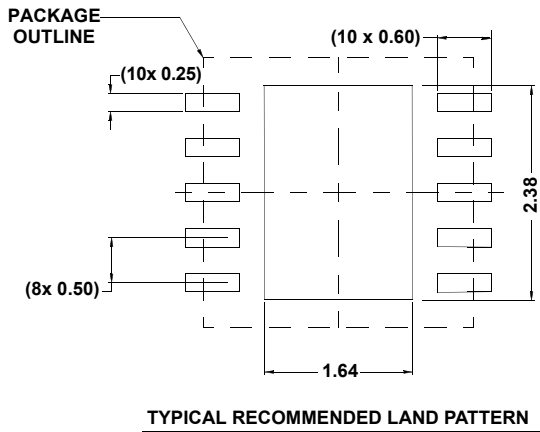
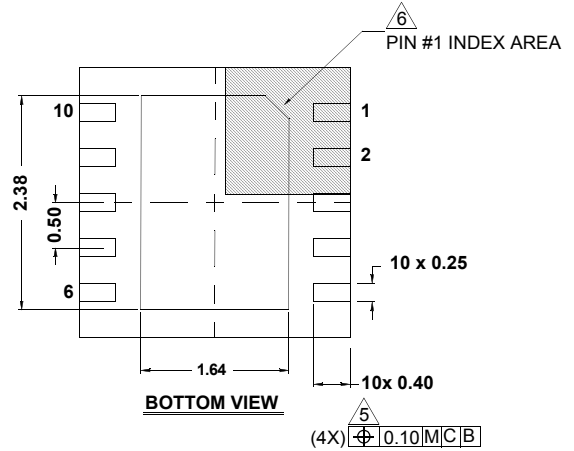
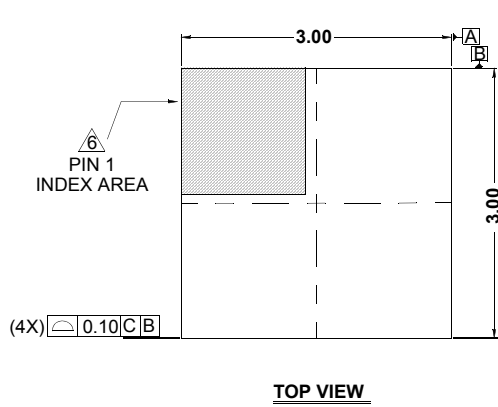

**NOTES:**

1. Dimensions are in millimeters.  
Dimensions in ( ) for Reference Only.
2. Dimensioning and tolerancing conform to AMSE Y14.5m-1994.
3. Unless otherwise specified, tolerance : Decimal  $\pm 0.05$
4. Dimension b applies to the metallized terminal and is measured between 0.18mm and 0.30mm from the terminal tip.
5. Tiebar shown (if present) is a non-functional feature.
6. The configuration of the pin #1 identifier is optional, but must be located within the zone indicated. The pin #1 identifier may be either a mold or mark feature.
7. COMPLAINT TO JEDEC MO-229-WEED-3 except for E-PAD dimensions.