

HiPerFRED²

$$V_{RRM} = 400V$$

$$I_{FAV} = 60A$$

$$t_{rr} = 60ns$$

High Performance Fast Recovery Diode
 Low Loss and Soft Recovery
 Single Diode

Part number

DPF60IM400HB

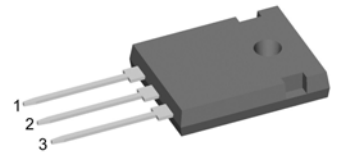

Backside: cathode

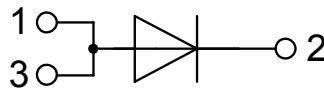
**Features / Advantages:**

- Planar passivated chips
- Very low leakage current
- Very short recovery time
- Improved thermal behaviour
- Very low I_{rm} -values
- Very soft recovery behaviour
- Avalanche voltage rated for reliable operation
- Soft reverse recovery for low EMI/RFI
- Low I_{rm} reduces:
 - Power dissipation within the diode
 - Turn-on loss in the commutating switch

Applications:

- Antiparallel diode for high frequency switching devices
- Antisaturation diode
- Snubber diode
- Free wheeling diode
- Rectifiers in switch mode power supplies (SMPS)
- Uninterruptible power supplies (UPS)

Package: TO-247

- Industry standard outline
- RoHS compliant
- Epoxy meets UL 94V-0

| Fast Diode | | | | Ratings | | |
|------------|--|---|-------------------------|---------|------|------------|
| Symbol | Definition | Conditions | min. | typ. | max. | Unit |
| V_{RSM} | max. non-repetitive reverse blocking voltage | $T_{VJ} = 25^{\circ}C$ | | | 400 | V |
| V_{RRM} | max. repetitive reverse blocking voltage | $T_{VJ} = 25^{\circ}C$ | | | 400 | V |
| I_R | reverse current, drain current | $V_R = 400 V$ | $T_{VJ} = 25^{\circ}C$ | | 10 | μA |
| | | $V_R = 400 V$ | $T_{VJ} = 150^{\circ}C$ | | 0.5 | mA |
| V_F | forward voltage drop | $I_F = 60 A$ | $T_{VJ} = 25^{\circ}C$ | | 1.27 | V |
| | | $I_F = 120 A$ | | | 1.53 | V |
| | | $I_F = 60 A$ | $T_{VJ} = 150^{\circ}C$ | | 1.09 | V |
| | | $I_F = 120 A$ | | | 1.39 | V |
| I_{FAV} | average forward current | $T_C = 130^{\circ}C$ rectangular $d = 0.5$ | $T_{VJ} = 175^{\circ}C$ | | 60 | A |
| V_{FO} | threshold voltage | } for power loss calculation only | $T_{VJ} = 175^{\circ}C$ | | 0.76 | V |
| r_F | slope resistance | | | | 4.9 | m Ω |
| R_{thJC} | thermal resistance junction to case | | | | 0.55 | K/W |
| R_{thCH} | thermal resistance case to heatsink | | | 0.25 | | K/W |
| P_{tot} | total power dissipation | | $T_C = 25^{\circ}C$ | | 275 | W |
| I_{FSM} | max. forward surge current | $t = 10 ms; (50 Hz), sine; V_R = 0 V$ | $T_{VJ} = 45^{\circ}C$ | | 600 | A |
| C_J | junction capacitance | $V_R = 200 V$ $f = 1 MHz$ | $T_{VJ} = 25^{\circ}C$ | | 61 | pF |
| I_{RM} | max. reverse recovery current | } $I_F = 60 A; V_R = 270 V$ $-di_F/dt = 200 A/\mu s$ | $T_{VJ} = 25^{\circ}C$ | | 6 | A |
| t_{rr} | reverse recovery time | | $T_{VJ} = 125^{\circ}C$ | | 12 | A |
| | | | $T_{VJ} = 25^{\circ}C$ | | 60 | ns |
| | | | $T_{VJ} = 125^{\circ}C$ | | 105 | ns |

| Package TO-247 | | | Ratings | | | |
|----------------|------------------------------|--------------|---------|------|------|------|
| Symbol | Definition | Conditions | min. | typ. | max. | Unit |
| I_{RMS} | RMS current | per terminal | | | 70 | A |
| T_{VJ} | virtual junction temperature | | -55 | | 175 | °C |
| T_{op} | operation temperature | | -55 | | 150 | °C |
| T_{stg} | storage temperature | | -55 | | 150 | °C |
| Weight | | | | 6 | | g |
| M_D | mounting torque | | 0.8 | | 1.2 | Nm |
| F_C | mounting force with clip | | 20 | | 120 | N |

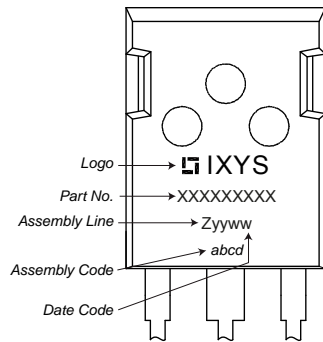
Product Marking

Part number

D = Diode
 P = HiPerFRED
 F = ultra fast
 60 = Current Rating [A]
 IM = Single Diode
 400 = Reverse Voltage [V]
 HB = TO-247AD (3)

| Ordering | Part Number | Marking on Product | Delivery Mode | Quantity | Code No. |
|----------|--------------|--------------------|---------------|----------|----------|
| Standard | DPF60IM400HB | DPF60IM400HB | Tube | 30 | 503573 |

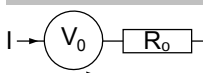
| Similar Part | Package | Voltage class |
|--------------|--------------|---------------|
| DPG60IM400QB | TO-3P (3) | 400 |
| DPG60I400HA | TO-247AD (2) | 400 |

Equivalent Circuits for Simulation
** on die level*
 $T_{VJ} = 175\text{ °C}$

Fast Diode

| | | | |
|--------------|--------------------|------|----|
| $V_{0\ max}$ | threshold voltage | 0.76 | V |
| $R_{0\ max}$ | slope resistance * | 2.3 | mΩ |

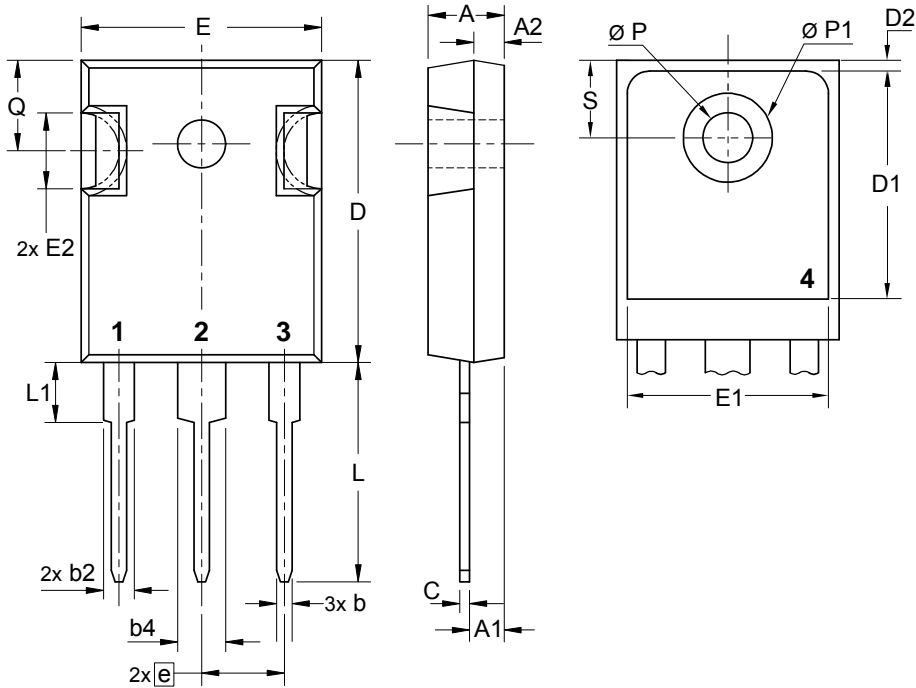
Outlines TO-247

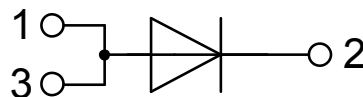

| Sym. | Inches | | Millimeter | |
|------|-----------|-------|------------|-------|
| | min. | max. | min. | max. |
| A | 0.185 | 0.209 | 4.70 | 5.30 |
| A1 | 0.087 | 0.102 | 2.21 | 2.59 |
| A2 | 0.059 | 0.098 | 1.50 | 2.49 |
| D | 0.819 | 0.845 | 20.79 | 21.45 |
| E | 0.610 | 0.640 | 15.48 | 16.24 |
| E2 | 0.170 | 0.216 | 4.31 | 5.48 |
| e | 0.215 BSC | | 5.46 BSC | |
| L | 0.780 | 0.800 | 19.80 | 20.30 |
| L1 | - | 0.177 | - | 4.49 |
| Ø P | 0.140 | 0.144 | 3.55 | 3.65 |
| Q | 0.212 | 0.244 | 5.38 | 6.19 |
| S | 0.242 BSC | | 6.14 BSC | |
| b | 0.039 | 0.055 | 0.99 | 1.40 |
| b2 | 0.065 | 0.094 | 1.65 | 2.39 |
| b4 | 0.102 | 0.135 | 2.59 | 3.43 |
| c | 0.015 | 0.035 | 0.38 | 0.89 |
| D1 | 0.515 | - | 13.07 | - |
| D2 | 0.020 | 0.053 | 0.51 | 1.35 |
| E1 | 0.530 | - | 13.45 | - |
| Ø P1 | - | 0.29 | - | 7.39 |



Fast Diode

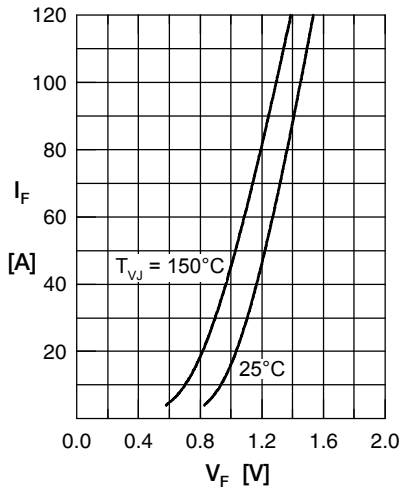

Fig. 1 Forward current I_F versus V_F

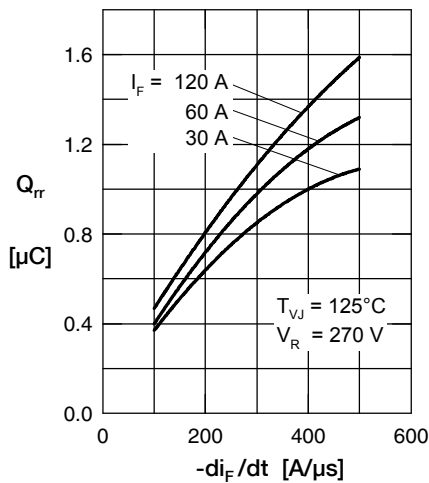

Fig. 2 Typ. reverse recov. charge Q_{rr} versus $-di_F/dt$

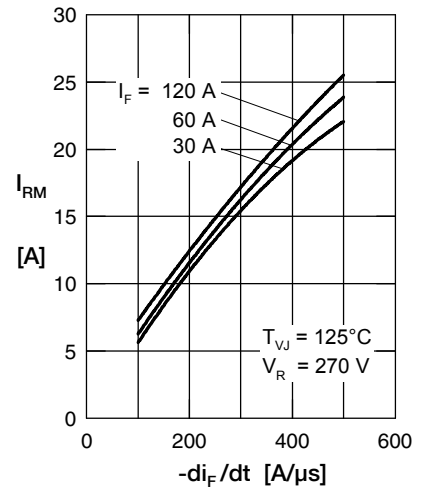

Fig. 3 Typ. reverse recovery current I_{RM} versus $-di_F/dt$

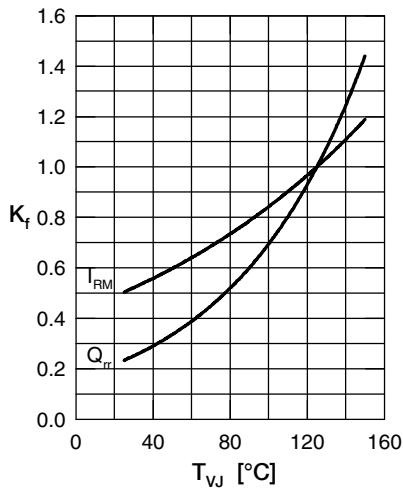

Fig. 4 Typ. dynamic parameters Q_{rr} , I_{RM} versus T_{VJ}

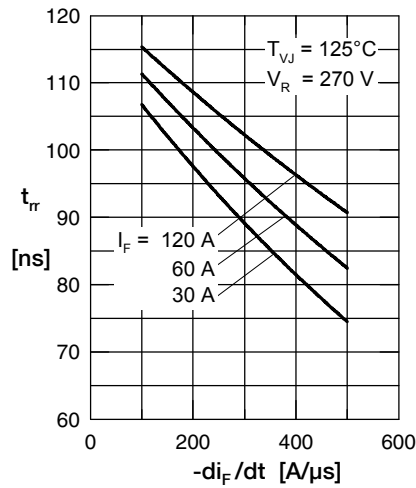

Fig. 5 Typ. reverse recov. time t_{tr} versus $-di_F/dt$

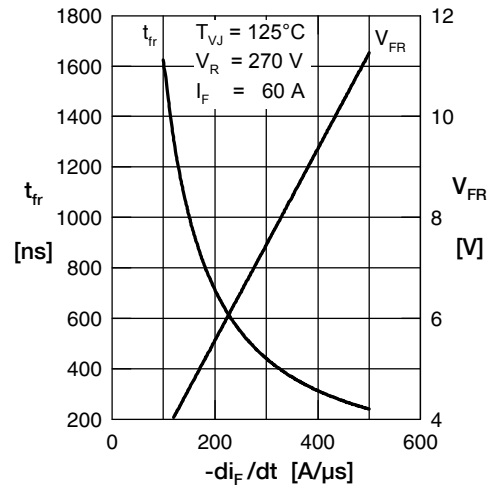

Fig. 6 Typ. forward recovery voltage V_{FR} & reco. time t_{tr} vs. di_F/dt

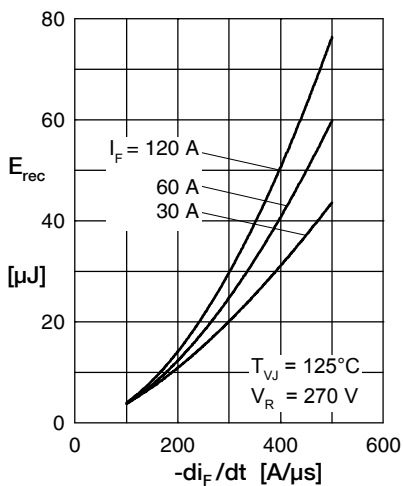

Fig. 7 Typ. recovery energy E_{rec} versus $-di_F/dt$

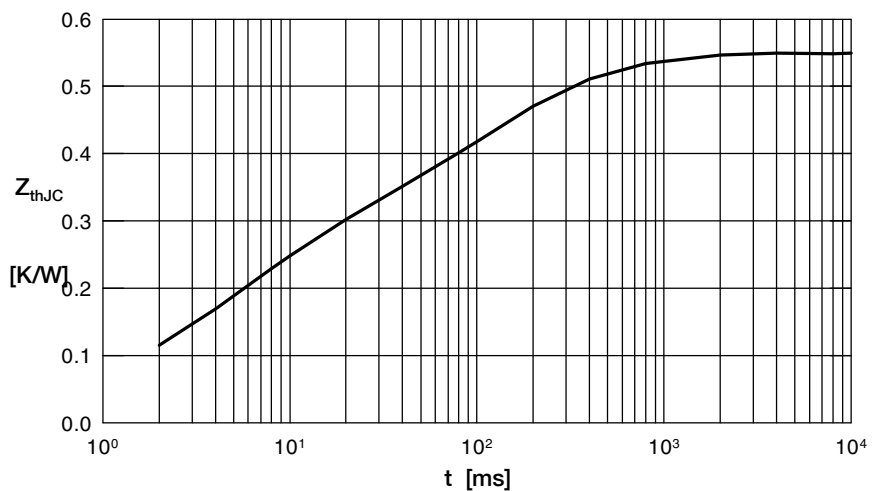

Fig. 8 Transient thermal impedance junction to case

Mouser Electronics

Authorized Distributor

Click to View Pricing, Inventory, Delivery & Lifecycle Information:

[IXYS:](#)

[DPF60IM400HB](#)