

## Overview

The KEMET MPCH metal composite inductors are designed for use in power supplies with ripple currents up to 32 A. These inductors offer superior permeability when compared to technologies based on ferrite cores.

The flat wire design allows for high efficiency under high current loads.

## Applications

- Switching DC-DC power supplies
- Notebook computers
- Tablets
- Embedded computer systems
- Servers and storage
- HDTVs

## Benefits

- Metal composite powder
- Operating temperature up to +125°C
- High current
- High permeability
- Low DCR
- Low acoustic noise



## Part Number System

MPCH	0730	L	R12
Series	Size Code	Inductor	Inductance Code $\mu\text{H}$
MPCH	0730 0740 1040 1055 1060 1250		R = Decimal point Examples: R12 = 0.12 $\mu\text{H}$ 1R3 = 1.30 $\mu\text{H}$

## Performance Characteristics

Item	Performance Characteristics
Operating temperature	-40°C to +125°C (including self-temperature rise)
Rated inductance range	0.12 – 1.50 $\mu$ H at 100 kHz, 1 mA
Inductance tolerance	$\pm$ 20%
Rated DC resistance range	0.65 – 2.30 m $\Omega$
DC resistance tolerance	$\pm$ 10%
Rated current range	17 – 32 A

**Table 1 – Ratings & Part Number Reference**

Part Number	Inductance ( $\mu$ H) at 100 kHz, 1 mA	Inductance Tolerance	DC Resistance (m $\Omega$ ) $\pm$ 10%	Rated Current (A)	
				I <sub>rms</sub> <sup>1</sup> (Ref.)	I <sub>sat</sub> <sup>2</sup> (Ref.)
MPCH0730LR12	0.12	$\pm$ 20%	0.65	31.00	32.00
MPCH0730LR24	0.24	$\pm$ 20%	1.20	23.00	18.50
MPCH0740LR15	0.15	$\pm$ 20%	0.93	29.00	31.00
MPCH0740LR24	0.24	$\pm$ 20%	0.96	27.00	20.00
<b>MPCH0740LR36E*</b>	<b>0.36</b>	<b><math>\pm</math>20%</b>	<b>1.42</b>	<b>23.00</b>	<b>22.00</b>
MPCH1040LR36	0.36	$\pm$ 20%	0.88	28.00	24.00
MPCH1040LR68	0.68	$\pm$ 20%	1.35	22.00	24.00
MPCH1040LR1R0	1.00	$\pm$ 20%	2.30	17.00	17.00
MPCH1055LR1R3	1.30	$\pm$ 20%	2.30	18.50	17.00
MPCH1060LR45	0.45	$\pm$ 20%	0.76	32.00	32.00
MPCH1250LR1R5	1.50	$\pm$ 20%	2.20	21.00	21.00

<sup>1</sup> T = 40 K rise at rated current.

<sup>2</sup> Inductance drop 20% at rated current.

\* This part is not for new design.

## DC-Superposed Characteristics

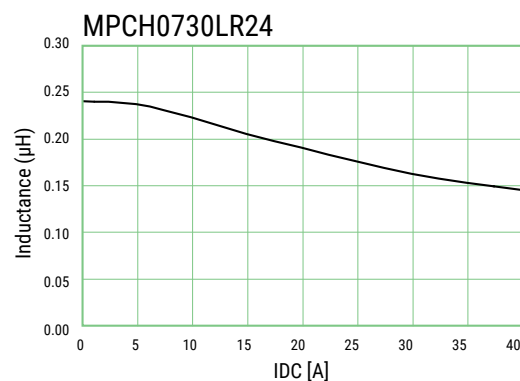
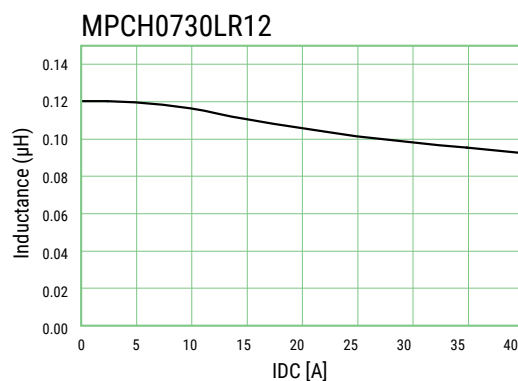

## DC-Superposed Characteristics cont'd

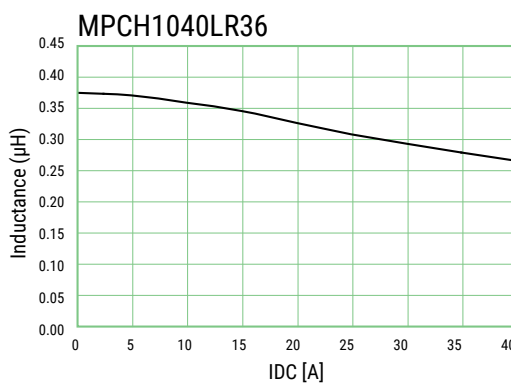
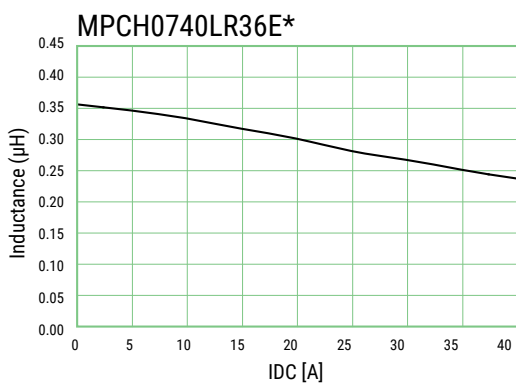
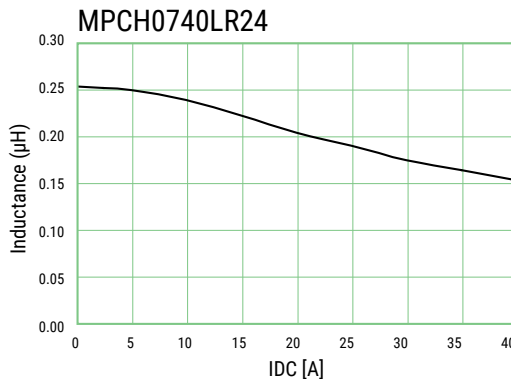
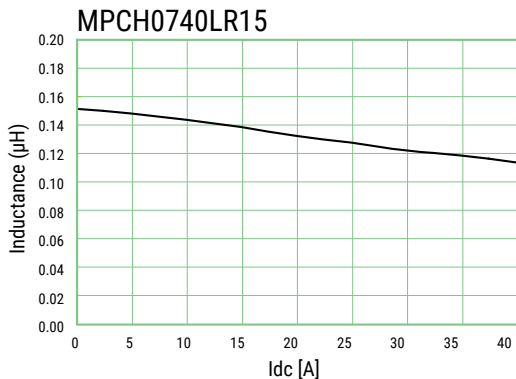

**\* This part is not for new design.**

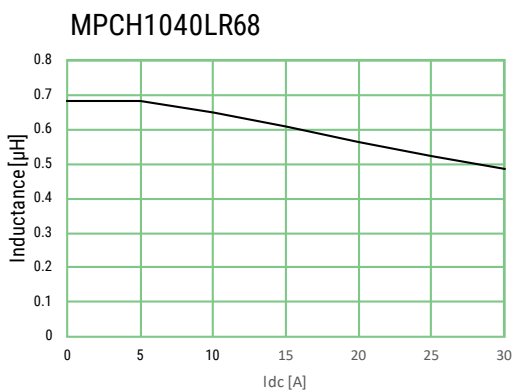

## DC-Superposed Characteristics cont'd

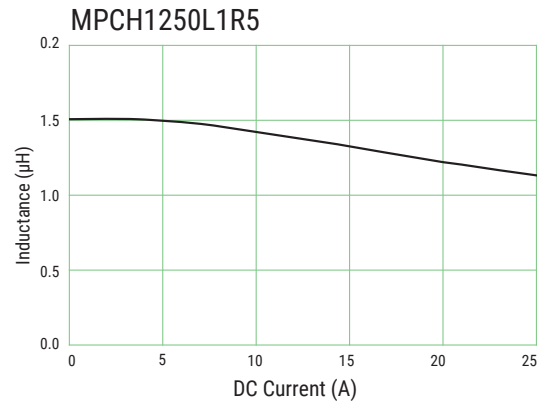
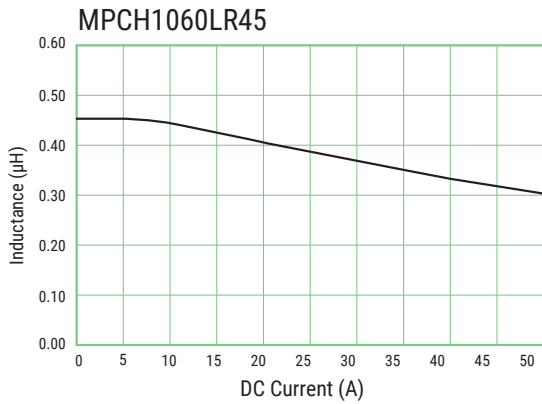
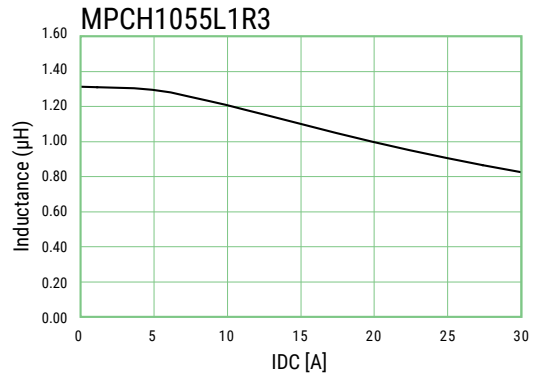
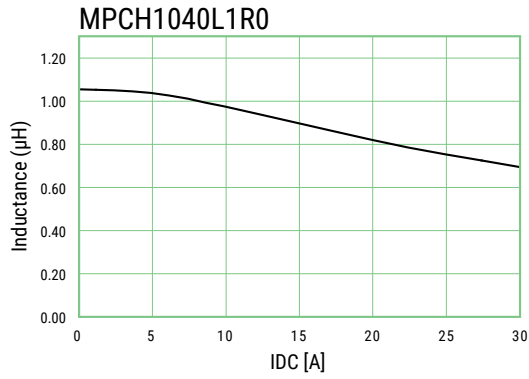

## Dimensions

Case Size	Dimensions (mm)	Land Pattern (mm)
"MPCH0730 MPCH0740"		
MPCH1040		
MPCH1055		
MPCH1060		
MPCH1250		

## Taping Specification

Dimensions of indented square hole plastic tape

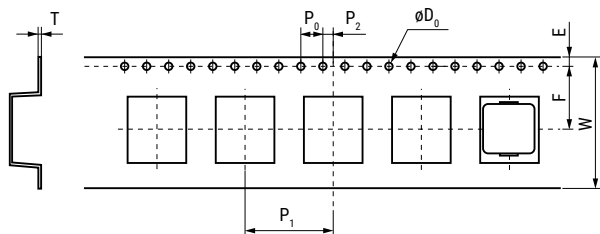

Case Size	Reel Quantity		Dimensions (mm)								
			W	F	E	P <sub>1</sub>	P <sub>2</sub>	P <sub>0</sub>	øD <sub>0</sub>	T	
MPCH0730 MPCH0740	1,000	Tolerance	±0.2	±0.1	±0.1	±0.1	±0.1	±0.1	±0.1	±0.05	±0.05
		Nominal	16.0	7.5	1.75	12.0	2.0	4.0	1.55	0.4	
MPCH1040	1,000	Tolerance	±0.3	±0.1	±0.1	±0.1	±0.1	±0.1	±0.1	±0.05	±0.05
		Nominal	24.0	11.5	1.75	16.0	2.0	4.0	1.55	0.4	
MPCH1055	500	Tolerance	±0.2	±0.1	±0.1	±0.1	±0.1	±0.1	±0.1	±0.05	±0.05
		Nominal	24.0	11.5	1.75	24.0	2.0	4.0	1.55	0.4	
MPCH1060		Tolerance	±0.2	±0.1	±0.1	±0.1	±0.1	±0.1	±0.1	±0.05	±0.05
		Nominal	24.0	11.5	1.75	24.0	2.0	4.0	1.55	0.4	
MPCH1250		Tolerance	±0.2	±0.1	±0.1	±0.1	±0.1	±0.1	±0.1	±0.05	±0.05
		Nominal	24.0	11.5	1.75	24.0	2.0	4.0	1.55	0.4	

## Reel Specifications

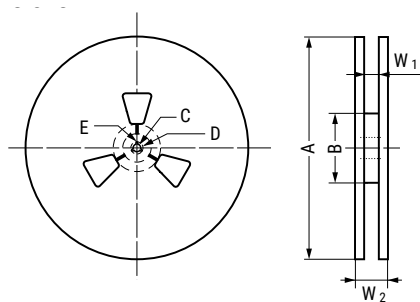

Case Size		Dimensions (mm)							
		A	B	C	D	E	r	W <sub>1</sub>	W <sub>2</sub>
MPCH0730, MPCH0740	Tolerance	±2.0	±1.0	±0.2	±0.8	±0.5		±1.0	±1.0
	Nominal	ø330	ø80	ø13.0	ø21.0	2.0	R1.0	17.5	21.5
MPCH1040	Tolerance	±5.0	±5.0	±0.5	±1.0	±0.5		±2.0	±3.0
	Nominal	ø330	ø80	ø13.5	ø21.0	2.0	R1.0	24.4	30.4
MPCH1055 MPCH1060 MPCH1250	Tolerance	±2.0	±1.0	±0.5	±0.8	±0.5		±2.0	±3.0
	Nominal	ø380	ø100	ø13.0	ø21.0	2.0	R1.0	24.4	30.4

## Soldering Process

### Recommended Reflow Soldering Profile

Reference ICP/JEDEC J-STD-020E

Profile Feature	Pb-Free Assembly
<b>Preheat/Soak</b>	
Temperature minimum ( $T_{smin}$ )	150°C
Temperature maximum ( $T_{smax}$ )	200°C
Time ( $t_s$ ) from $T_{smin}$ to $T_{smax}$	60 – 120 seconds
Ramp-up rate ( $T_L$ to $T_p$ )	3°C/second maximum
Liquidous temperature ( $T_L$ )	217°C
Time above liquidous ( $t_L$ )	60 – 150 seconds
Peak temperature ( $T_p$ )	250°C for MPCH07xx 245°C for MPCH1xxx
Time within 5°C of maximum peak temperature ( $t_p$ )	30 seconds maximum
Ramp-down rate ( $T_p$ to $T_L$ )	6°C/second maximum
Time 25°C to peak temperature	8 minutes maximum

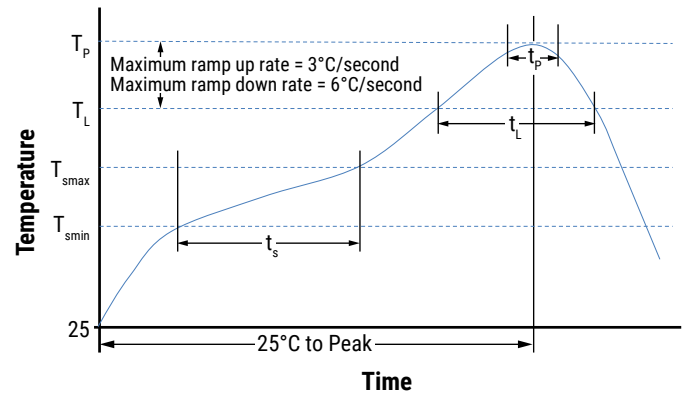

## Handling Precautions

Inductors should be stored in normal working environments. While the inductors themselves are quite robust in other environments, solderability will be degraded by exposure to high temperatures, high humidity, corrosive atmospheres, and long term storage.

KEMET recommends that maximum storage temperature not exceed 40°C and maximum storage humidity not exceed 70% relative humidity. Atmospheres should be free of chlorine and sulfur bearing compounds. Temperature fluctuations should be minimized to avoid condensation on the parts. For optimized solderability, inductors' stock should be used promptly, preferably within six months of receipt.

## Export Control

### For customers in Japan

For products which are controlled items subject to the "Foreign Exchange and Foreign Trade Law" of Japan, the export license specified by the law is required for export.

### For customers outside Japan

Inductors should not be used or sold for use in the development, production, stockpiling or utilization of any conventional weapons or mass-destruction weapons (nuclear, chemical, biological weapons or missiles), or any other weapons.

## KEMET Electronics Corporation Sales Offices

For a complete list of our global sales offices, please visit [www.kemet.com/sales](http://www.kemet.com/sales).

---

### Disclaimer

All product specifications, statements, information and data (collectively, the "Information") in this datasheet are subject to change. The customer is responsible for checking and verifying the extent to which the Information contained in this publication is applicable to an order at the time the order is placed. All Information given herein is believed to be accurate and reliable, but it is presented without guarantee, warranty, or responsibility of any kind, expressed or implied.

Statements of suitability for certain applications are based on KEMET Electronics Corporation's ("KEMET") knowledge of typical operating conditions for such applications, but are not intended to constitute – and KEMET specifically disclaims – any warranty concerning suitability for a specific customer application or use. The Information is intended for use only by customers who have the requisite experience and capability to determine the correct products for their application. Any technical advice inferred from this Information or otherwise provided by KEMET with reference to the use of KEMET's products is given gratis, and KEMET assumes no obligation or liability for the advice given or results obtained.

Although KEMET designs and manufactures its products to the most stringent quality and safety standards, given the current state of the art, isolated component failures may still occur. Accordingly, customer applications which require a high degree of reliability or safety should employ suitable designs or other safeguards (such as installation of protective circuitry or redundancies) in order to ensure that the failure of an electrical component does not result in a risk of personal injury or property damage.

Although all product-related warnings, cautions and notes must be observed, the customer should not assume that all safety measures are indicated or that other measures may not be required.

*KEMET is a registered trademark of KEMET Electronics Corporation.*



# Mouser Electronics

Authorized Distributor

Click to View Pricing, Inventory, Delivery & Lifecycle Information:

## KEMET:

[MPCH0740LR15](#) [MPCH0730LR12](#) [MPCH1040LR36](#) [MPCH1060LR45](#) [MPCH1250L1R5](#) [MPCH0730LR24](#)  
[MPCH0740LR24](#) [MPCH0740LR36E](#) [MPCH0740LR26](#) [MPCH1055L1R3](#) [MPCH1040L1R0](#)