

## Automotive-grade N-channel 55 V, 6.5 mΩ typ., 80 A STripFET F3 Power MOSFET in a DPAK package

**DPAK**

AM01475v1\_noZen

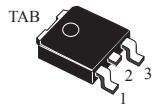
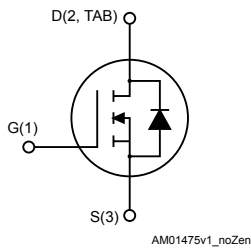

### Features

Type	V <sub>DS</sub>	R <sub>DS(on)</sub> max.	I <sub>D</sub>	P <sub>TOT</sub>
STD65N55F3	55 V	8.5 mΩ	80 A	110 W

- AEC-Q101 qualified
- 100% avalanche tested

### Applications

- Switching applications

### Description

This device is an N-channel Power MOSFET developed using STripFET™ F3 technology. It is designed to minimize on-resistance and gate charge to provide superior switching performance.

#### Product status

STD65N55F3

#### Product summary

<b>Order code</b>	STD65N55F3
<b>Marking</b>	65N55F3
<b>Package</b>	DPAK
<b>Packing</b>	Tape and reel

# 1 Electrical ratings

**Table 1. Absolute maximum ratings**

Symbol	Parameter	Value	Unit
$V_{DS}$	Drain-source voltage	55	V
$V_{GS}$	Gate-source voltage	±20	V
$I_D$	Drain current (continuous) at $T_C = 25\text{ °C}$	80	A
	Drain current (continuous) at $T_C = 100\text{ °C}$	56	A
$I_{DM}^{(1)}$	Drain current (pulsed)	320	A
$P_{TOT}$	Total dissipation at $T_C = 25\text{ °C}$	110	W
$dv/dt^{(2)}$	Peak diode recovery	11	V/ns
$E_{AS}^{(3)}$	Single pulse avalanche energy	390	mJ
$T_j$	Operating junction temperature range	-55 to 175	°C
$T_{stg}$	Storage temperature range		

1. Pulse width is limited by safe operating area.
2.  $I_{SD} \leq 65\text{ A}$ ,  $di/dt \leq 300\text{ A}/\mu\text{s}$ ,  $V_{DD} \leq V_{(BR)DSS}$ ,  $T_j \leq T_{jmax}$
3. Starting  $T_j = 25\text{ °C}$ ,  $I_D = 32\text{ A}$ ,  $V_{DD} = 25\text{ V}$

**Table 2. Thermal resistance**

Symbol	Parameter	Value	Unit
$R_{thj-case}$	Thermal resistance junction-case	1.36	°C/W
$R_{thj-pcb}^{(1)}$	Thermal resistance junction-pcb	50	°C/W

1. When mounted on an 1- inch<sup>2</sup> FR-4 board, 2oz Cu.

## 2 Electrical characteristics

$T_C = 25\text{ °C}$  unless otherwise specified

**Table 3. Static characteristics**

Symbol	Parameter	Test conditions	Min.	Typ.	Max.	Unit
$V_{(BR)DSS}$	Drain-source breakdown voltage	$V_{GS} = 0\text{ V}$ , $I_D = 250\text{ }\mu\text{A}$	55			V
$I_{DSS}$	Zero gate voltage drain current	$V_{GS} = 0\text{ V}$ , $V_{DS} = 55\text{ V}$			10	$\mu\text{A}$
		$V_{GS} = 0\text{ V}$ , $V_{DS} = 55\text{ V}$ , $T_C = 125\text{ °C}^{(1)}$			100	$\mu\text{A}$
$I_{GSS}$	Gate-body leakage current	$V_{GS} = \pm 20\text{ V}$ , $V_{DS} = 0\text{ V}$			$\pm 200$	nA
$V_{GS(th)}$	Gate threshold voltage	$V_{DS} = V_{GS}$ , $I_D = 250\text{ }\mu\text{A}$	2		4	V
$R_{DS(on)}$	Static drain-source on-resistance	$V_{GS} = 10\text{ V}$ , $I_D = 32\text{ A}$		6.5	8.5	m $\Omega$

1. Defined by design, not subject to production test.

**Table 4. Dynamic characteristics**

Symbol	Parameter	Test conditions	Min.	Typ.	Max.	Unit
$C_{iss}$	Input capacitance	$V_{DS} = 25\text{ V}$ , $f = 1\text{ MHz}$ , $V_{GS} = 0\text{ V}$	-	2200		pF
$C_{oss}$	Output capacitance		-	500		pF
$C_{riss}$	Reverse transfer capacitance		-	25		pF
$Q_g$	Total gate charge	$V_{DD} = 27\text{ V}$ , $I_D = 65\text{ A}$ ,	-	33.5	45	nC
$Q_{gs}$	Gate-source charge	$V_{GS} = 0$ to $10\text{ V}$	-	12.5		nC
$Q_{gd}$	Gate-drain charge	(see Figure 13. Test circuit for gate charge behavior)	-	9.5		nC

**Table 5. Switching times**

Symbol	Parameter	Test conditions	Min.	Typ.	Max.	Unit
$t_{d(on)}$	Turn-on delay time	$V_{DD} = 27\text{ V}$ , $I_D = 32\text{ A}$ , $R_G = 4.7\text{ }\Omega$ , $V_{GS} = 10\text{ V}$	-	20	-	ns
$t_r$	Rise time		-	50	-	ns
$t_{d(off)}$	Turn-off delay time	(see Figure 12. Test circuit for resistive load switching times and Figure 17. Switching time waveform)	-	35	-	ns
$t_f$	Fall time		-	11.5	-	ns

**Table 6. Source-drain diode**

Symbol	Parameter	Test conditions	Min.	Typ.	Max.	Unit
$I_{SD}$	Source-drain current				80	A
$I_{SDM}^{(1)}$	Source-drain current (pulsed)				320	A
$V_{SD}$	Forward on voltage	$I_{SD} = 65\text{ A}$ , $V_{GS} = 0\text{ V}$	-		1.5	V

Symbol	Parameter	Test conditions	Min.	Typ.	Max.	Unit
$t_{rr}$	Reverse recovery time	$I_{SD} = 65 \text{ A}$ , $di/dt = 100 \text{ A}/\mu\text{s}$ , $V_{DD} = 25 \text{ V}$ , $T_j = 150 \text{ }^\circ\text{C}$ (see <a href="#">Figure 14. Test circuit for inductive load switching and diode recovery times</a> )	-	47		ns
$Q_{rr}$	Reverse recovery charge		-	87		nC
$I_{RRM}$	Reverse recovery current		-	3.7		A

1. Pulsed: pulse duration = 300  $\mu\text{s}$ , duty cycle 1.5%

## 2.1 Electrical characteristics (curves)

Figure 1. Safe operating area

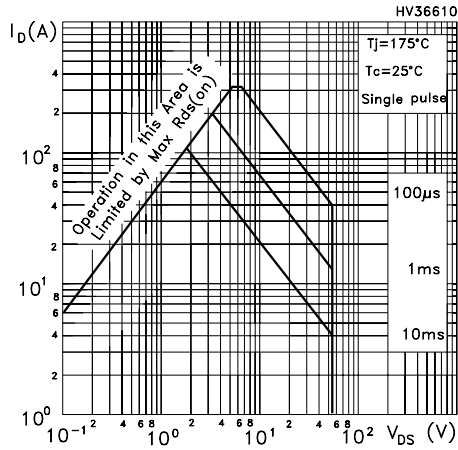

Figure 2. Thermal impedance

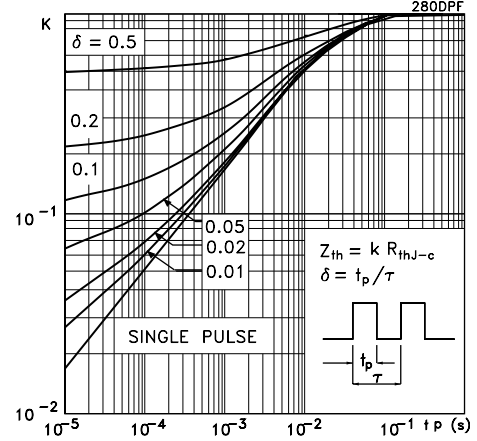

Figure 3. Output characteristics

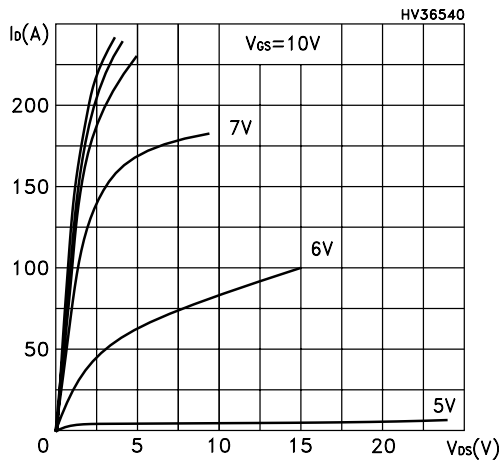

Figure 4. Transfer characteristics

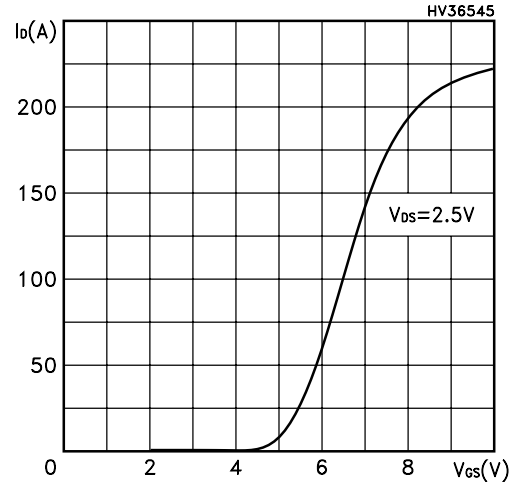

Figure 5. Normalized  $V_{(BR)DSS}$  vs temperature

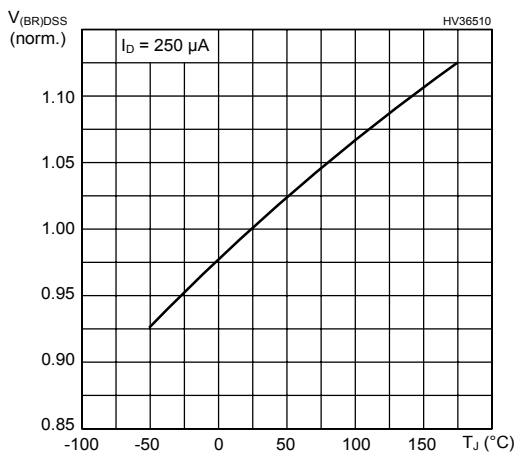

Figure 6. Static drain-source on-resistance

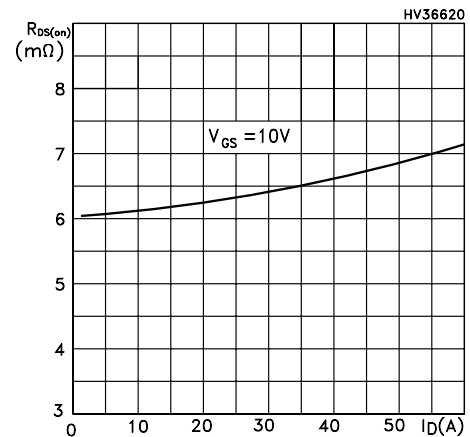

Figure 7. Gate charge vs gate-source voltage

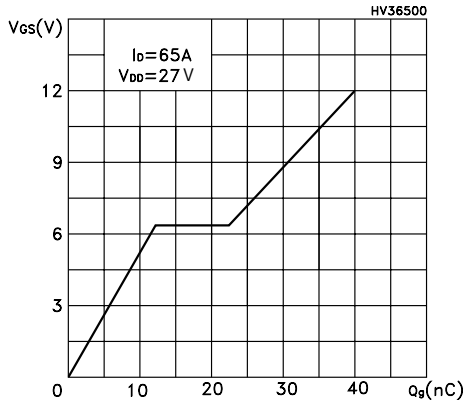

Figure 8. Capacitance variations

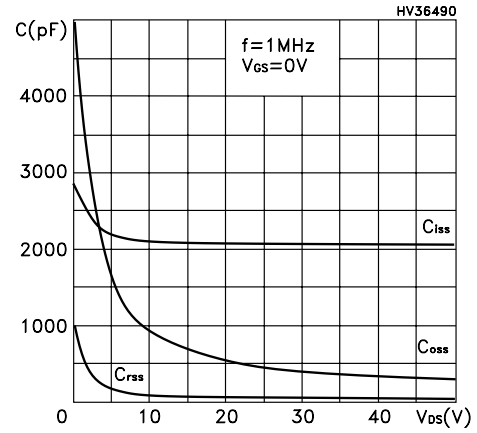

Figure 9. Normalized gate threshold voltage vs temperature

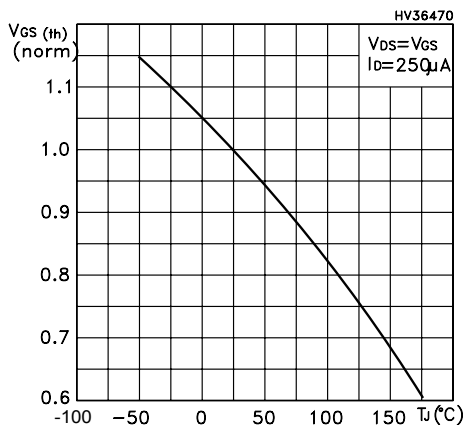

Figure 10. Normalized on-resistance vs temperature

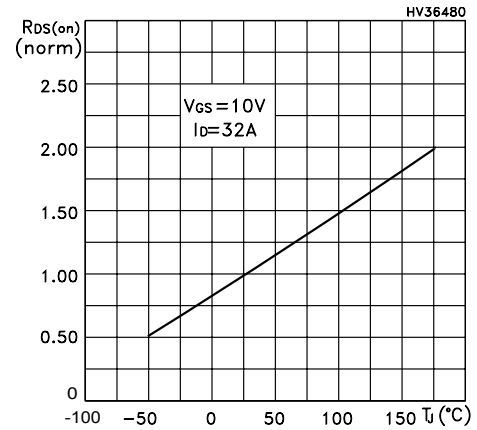
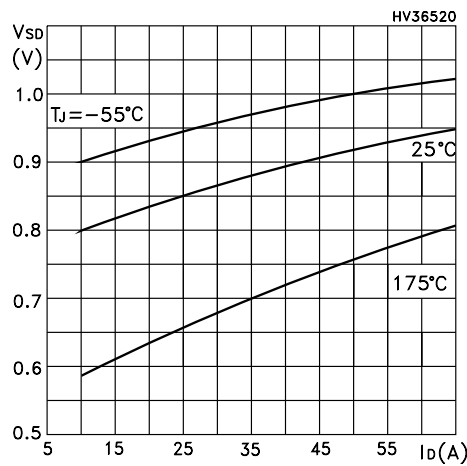
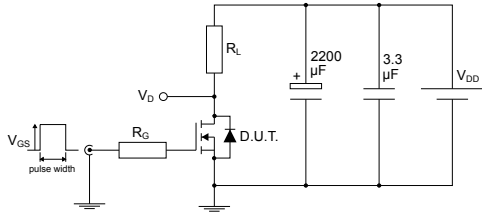

Figure 11. Source-drain diode forward characteristics



### 3 Test circuits

**Figure 12. Test circuit for resistive load switching times**

AM01468v1

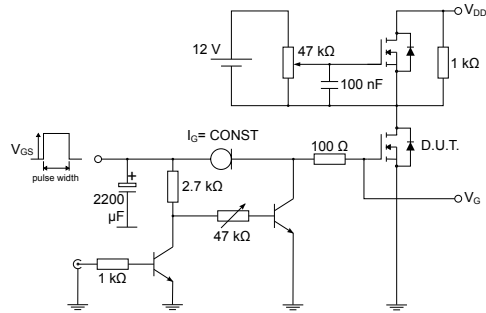
**Figure 13. Test circuit for gate charge behavior**

AM01469v1

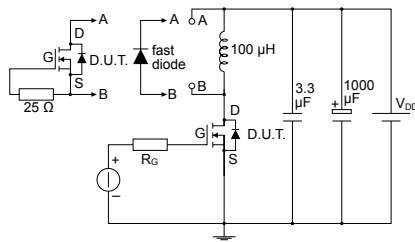
**Figure 14. Test circuit for inductive load switching and diode recovery times**

AM01470v1

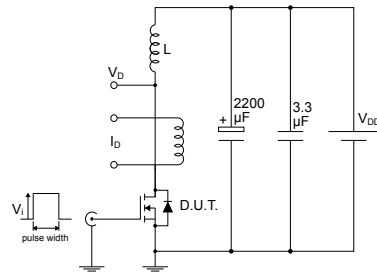
**Figure 15. Unclamped inductive load test circuit**

AM01471v1

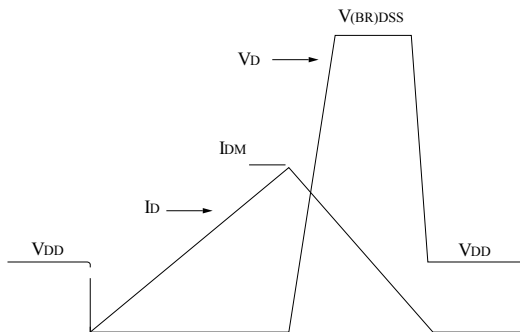
**Figure 16. Unclamped inductive waveform**

AM01472v1

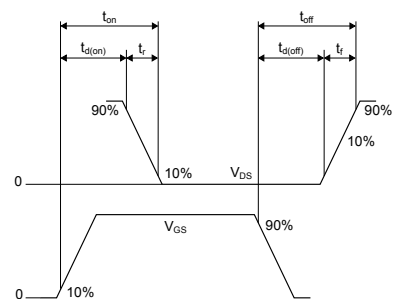
**Figure 17. Switching time waveform**

AM01473v1

## 4 Package information

---

In order to meet environmental requirements, ST offers these devices in different grades of ECOPACK® packages, depending on their level of environmental compliance. ECOPACK® specifications, grade definitions and product status are available at: [www.st.com](http://www.st.com). ECOPACK® is an ST trademark.



### 4.1 DPAK (TO-252) type A2 package information

Figure 18. DPAK (TO-252) type A2 package outline

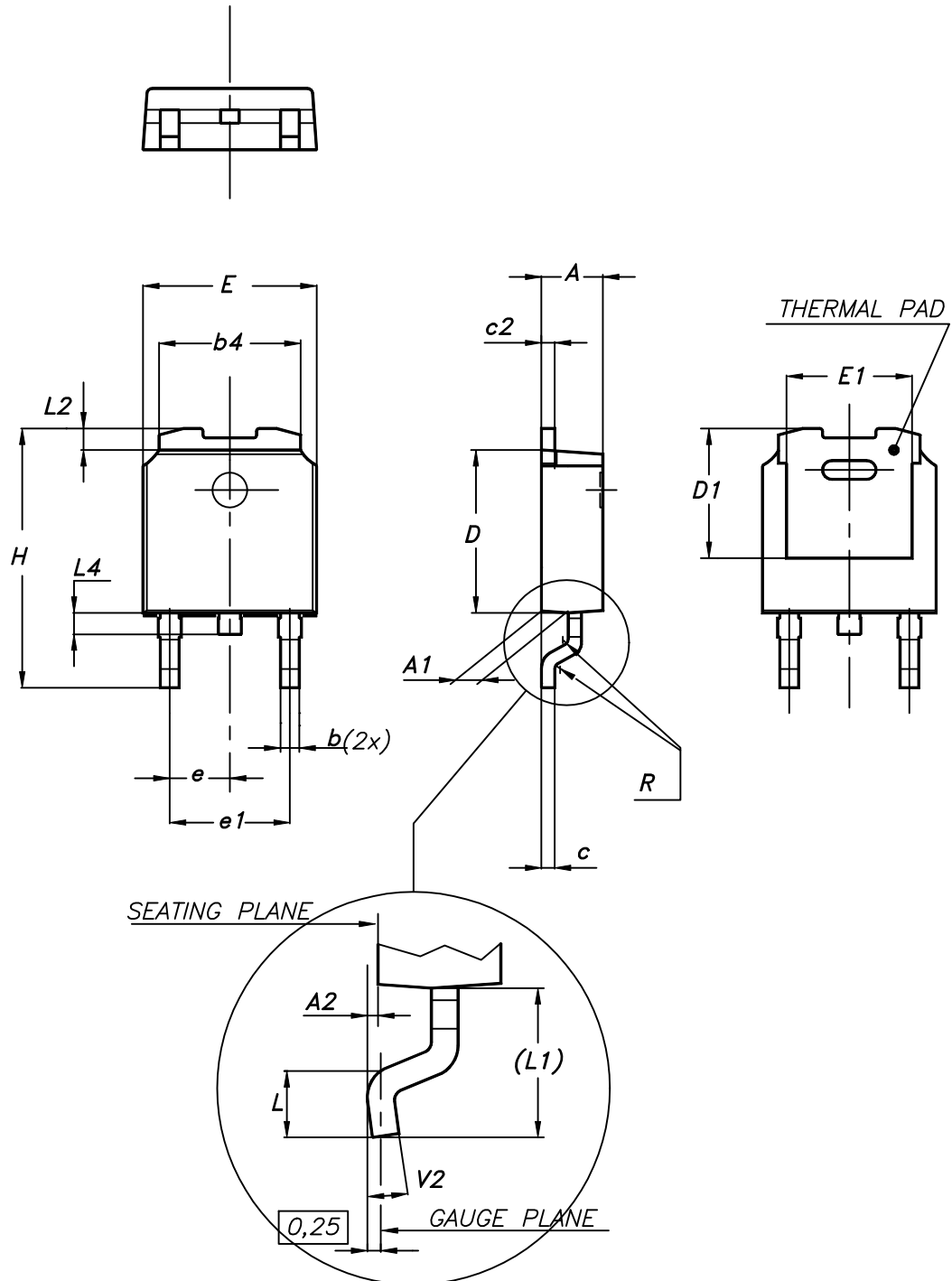

0068772\_type-A2\_rev24

**Table 7. DPAK (TO-252) type A2 mechanical data**

Dim.	mm		
	Min.	Typ.	Max.
A	2.20		2.40
A1	0.90		1.10
A2	0.03		0.23
b	0.64		0.90
b4	5.20		5.40
c	0.45		0.60
c2	0.48		0.60
D	6.00		6.20
D1	4.95	5.10	5.25
E	6.40		6.60
E1	5.10	5.20	5.30
e	2.16	2.28	2.40
e1	4.40		4.60
H	9.35		10.10
L	1.00		1.50
L1	2.60	2.80	3.00
L2	0.65	0.80	0.95
L4	0.60		1.00
R		0.20	
V2	0°		8°

**Figure 19. DPAK (TO-252) recommended footprint (dimensions are in mm)**

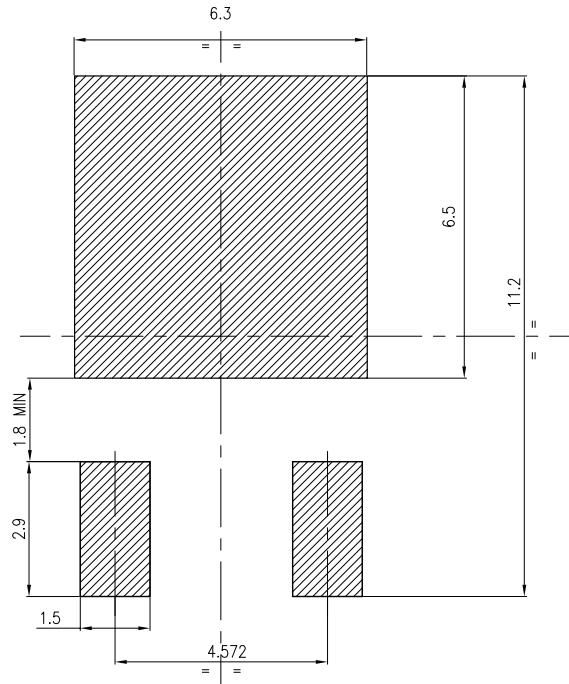

FP\_0068772\_24

## 4.2 DPAK (TO-252) packing information

Figure 20. DPAK (TO-252) tape outline

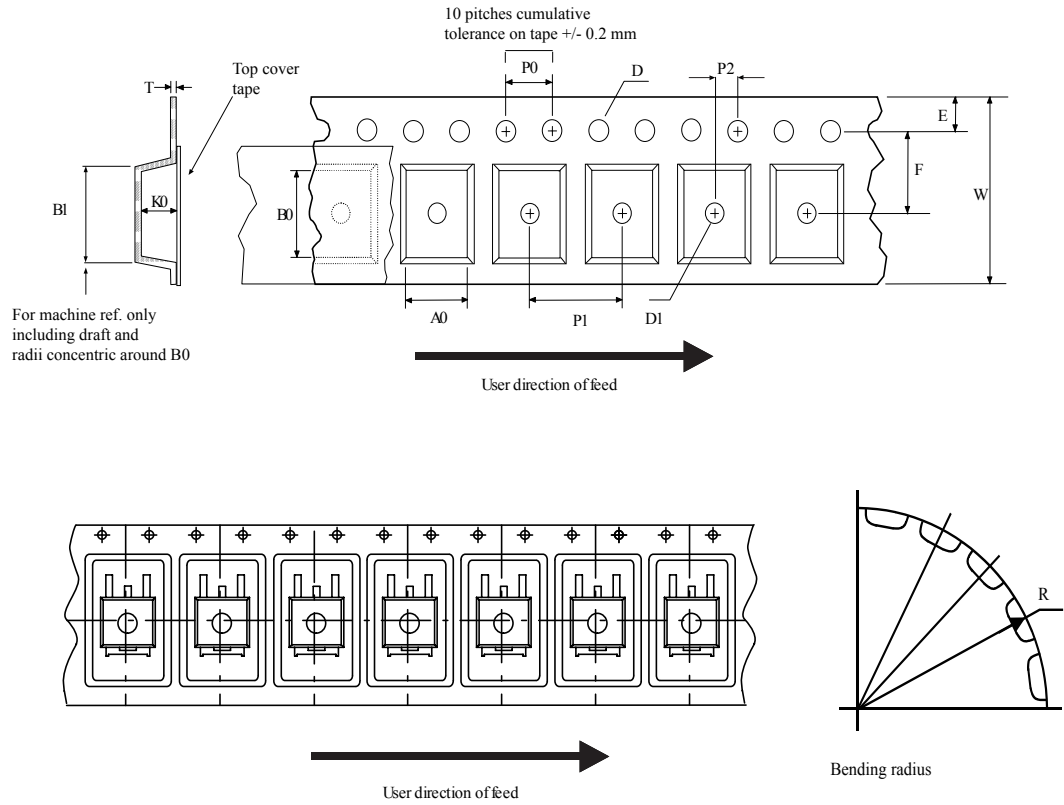

AM08852v1

**Figure 21. DPAK (TO-252) reel outline**

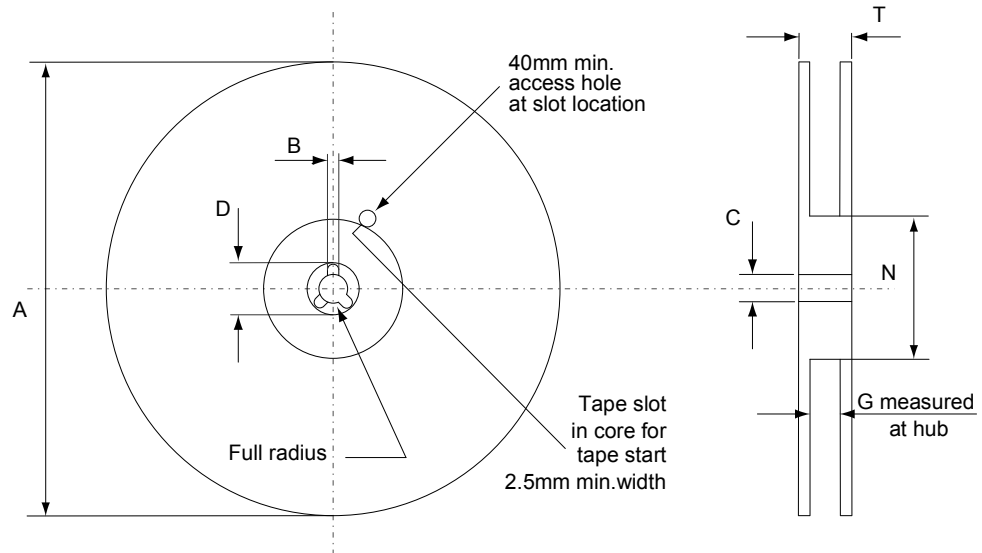

AM06038v1

**Table 8. DPAK (TO-252) tape and reel mechanical data**

Tape			Reel		
Dim.	mm		Dim.	mm	
	Min.	Max.		Min.	Max.
A0	6.8	7	A		330
B0	10.4	10.6	B	1.5	
B1		12.1	C	12.8	13.2
D	1.5	1.6	D	20.2	
D1	1.5		G	16.4	18.4
E	1.65	1.85	N	50	
F	7.4	7.6	T		22.4
K0	2.55	2.75			
P0	3.9	4.1	Base qty.		2500
P1	7.9	8.1	Bulk qty.		2500
P2	1.9	2.1			
R	40				
T	0.25	0.35			
W	15.7	16.3			

## Revision history

**Table 9. Document revision history**

Date	Version	Changes
08-Feb-2007	1	First release.
22-Feb-2007	2	Description has been changed
11-May-2007	3	Improved current values
13-Feb-2018	4	Updated information on cover page. Updated <a href="#">Section 1 Electrical ratings</a> and <a href="#">Section 2 Electrical characteristics</a> . Updated <a href="#">Section 4.1 DPAK (TO-252) type A2 package information</a> . Minor text changes

## Contents

<b>1</b>	<b>Electrical ratings</b> .....	<b>2</b>
<b>2</b>	<b>Electrical characteristics</b> .....	<b>3</b>
<b>2.1</b>	Electrical characteristics (curves).....	<b>5</b>
<b>3</b>	<b>Test circuits</b> .....	<b>7</b>
<b>4</b>	<b>Package information</b> .....	<b>8</b>
<b>4.1</b>	DPAK (TO-252) type A2 package information .....	<b>8</b>
<b>4.2</b>	DPAK (TO-252) packing information .....	<b>11</b>
	<b>Revision history</b> .....	<b>14</b>

**IMPORTANT NOTICE – PLEASE READ CAREFULLY**

STMicroelectronics NV and its subsidiaries (“ST”) reserve the right to make changes, corrections, enhancements, modifications, and improvements to ST products and/or to this document at any time without notice. Purchasers should obtain the latest relevant information on ST products before placing orders. ST products are sold pursuant to ST’s terms and conditions of sale in place at the time of order acknowledgement.

Purchasers are solely responsible for the choice, selection, and use of ST products and ST assumes no liability for application assistance or the design of Purchasers’ products.

No license, express or implied, to any intellectual property right is granted by ST herein.

Resale of ST products with provisions different from the information set forth herein shall void any warranty granted by ST for such product.

ST and the ST logo are trademarks of ST. All other product or service names are the property of their respective owners.

Information in this document supersedes and replaces information previously supplied in any prior versions of this document.

© 2018 STMicroelectronics – All rights reserved



# Mouser Electronics

Authorized Distributor

Click to View Pricing, Inventory, Delivery & Lifecycle Information:

[STMicroelectronics:](#)

[STD65N55F3](#)