

**PC TERMINAL OPTION**  
PL812705X SHOWN

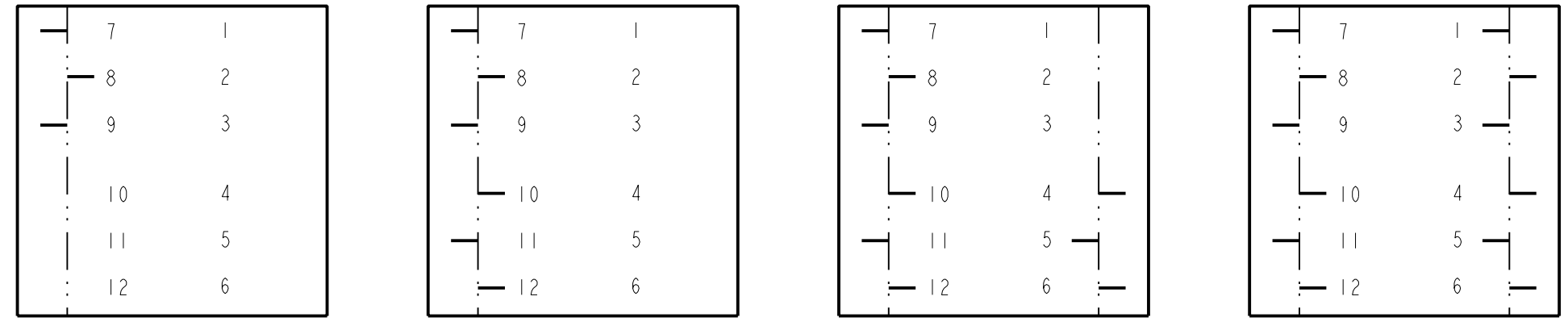

**P.C. TERMINAL LOCATION**

<b>PL</b> SERIES PL					
	<b>LAMP &amp; SWITCH HOUSING COLOR</b>	<b>CIRCUITRY</b>	<b>ACTION</b>	<b>PUSHBUTTON COLOR</b>	<b>RoHS COMPLIANT</b>

- 1 - SINGLE LAMP, BLACK HOUSING
  - 2 - TWIN LAMP, BLACK HOUSING
  - 3 - NON-ILLUMINATED, BLACK HOUSING
  - 4 - SINGLE LAMP, GRAY HOUSING
  - 5 - TWIN LAMP, GRAY HOUSING
  - 6 - NON-ILLUMINATED, GRAY HOUSING
  - 7 - SINGLE LAMP, BLACK HOUSING (PC TERMINALS)
  - 8 - TWIN LAMP, BLACK HOUSING (PC TERMINALS)
- 03 - 1C (SPDT)
  - 06 - 2C (2PDT)
  - 09 - 3C (3PDT)
  - 12 - 4C (4PDT)
  - 23 - 1C (8A)(SPDT)
  - 26 - 2C (8A)(2PDT)
  - 29 - 3C (8A)(3PDT)
  - 32 - 4C (8A)(4PDT)
- 2 - MOMENTARY
  - 7 - PUSH-LOCK/PUSH-RELEASE
- 00 - NONE
  - 01 - RED
  - 03 - GREEN
  - 04 - BLUE
  - 05 - WHITE
  - 08 - YELLOW
  - 12 - CLEAR
  - 13 - AMBER

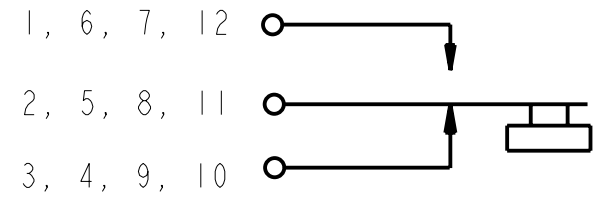
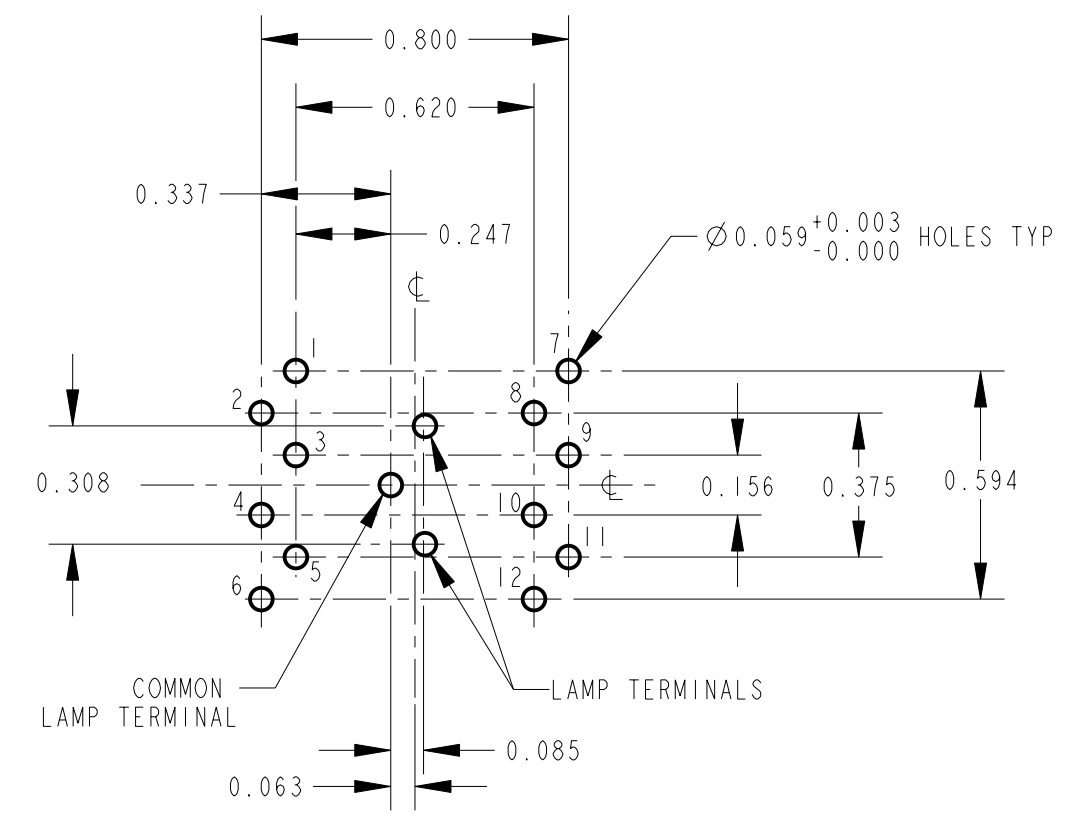

**SCHEMATIC**

**RECOMMENDED PCB LAYOUT**  
COMPONENT SIDE

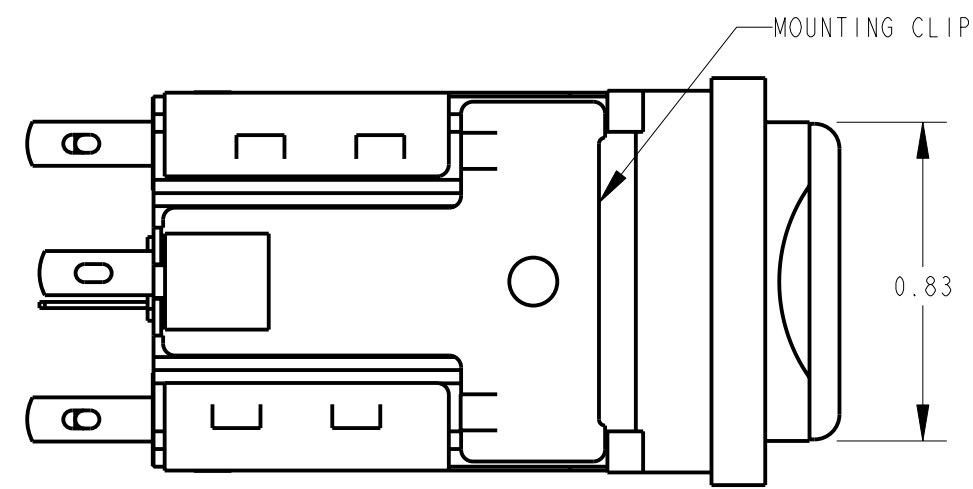

**SOLDER TERMINAL OPTION**  
PL212705X SHOWN

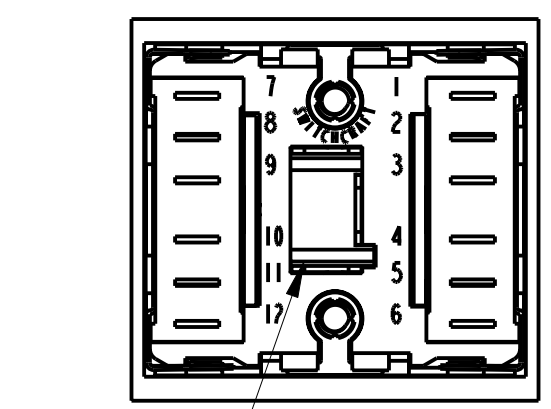

SOLDER LUGS ALSO ACCEPT 0.110 FASTON TERMINALS

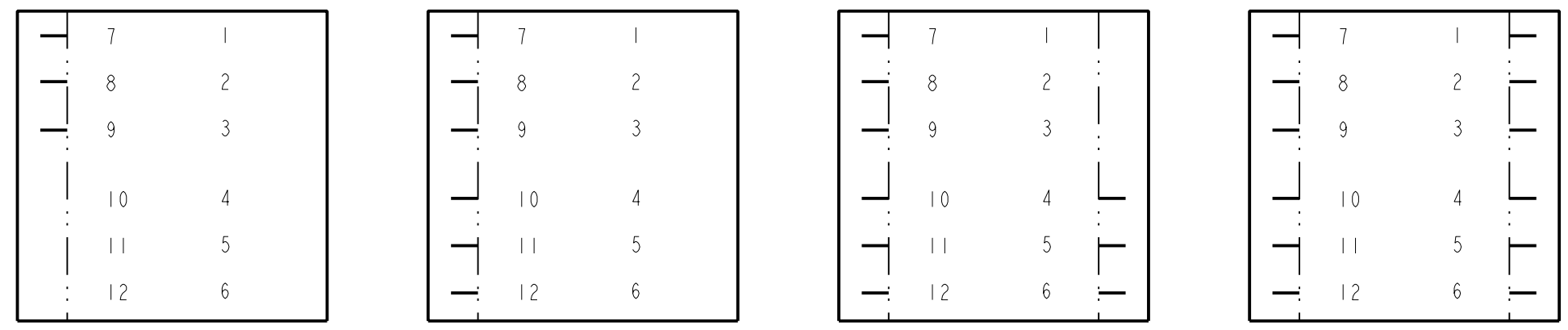

**SOLDER TERMINAL LOCATION**

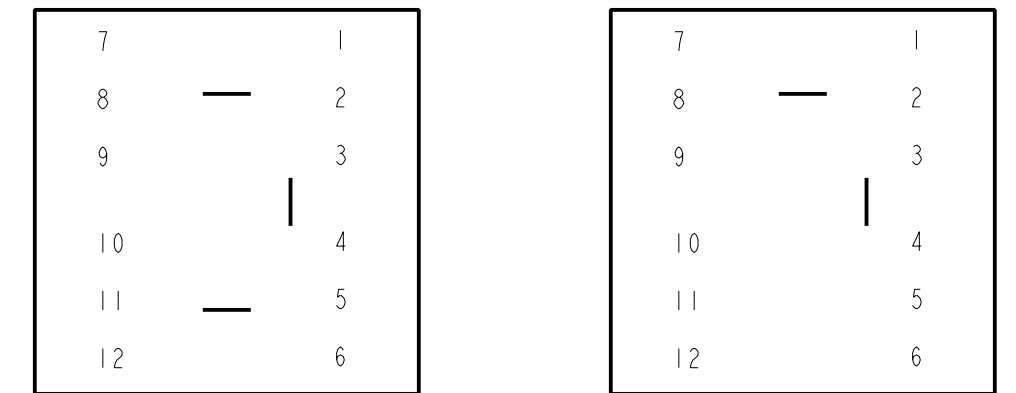

**DETAIL 'A'**  
LAMP TERMINAL LOCATION

**NOTES:**

- MATERIALS:  
HOUSING - THERMOPLASTIC, SEE TABLE FOR COLOR  
BUTTON - THERMOPLASTIC, SEE TABLE FOR COLOR  
TERMINALS - COPPER ALLOY, SILVER PLATED  
LAMP SOCKET - PLATED COPPER ALLOY
- MOUNTIN HOLE - 1.000 x 0.875 RECTANGLE.  
0.125 MAX PANEL THICKNESS.
- BUTTON TRAVEL - 0.22 WITH 0.09 FALL BACK ON PUSH-LOCK/PUSH-RELEASE.
- ACCEPTS STANDARD T 1-3/4 FLANGE BASE LAMPS (NOT SUPPLIED).
- THIS PRODUCT IS RoHS COMPLIANT.

**CUSTOMER DRAWING**

<p>★ STAR SYMBOL DENOTES CRITICAL DIMENSION</p> <p>UNLESS OTHERWISE SPECIFIED</p> <p>1. ALL DIMENSIONS IN INCHES - TWO PLACE DECIMALS ±0.01 - THREE PLACE DECIMALS ±0.005 - ANGLES ±1° - ALL DIA. CONCENTRIC WITHIN 0.005 T.I.R.</p> <p>2. FEATURES ON THE SAME CENTERLINE MUST BE ALIGNED WITHIN ±0.002</p> <p>3. REMOVE ALL BURRS</p>				<p>THIS DRAWING DESCRIBES A DESIGN CONSIDERED PROPRIETARY IN NATURE, DEVELOPED AND MANUFACTURED BY SWITCHCRAFT INC. AND IS RELEASED ON A CONFIDENTIAL BASIS FOR IDENTIFICATION PURPOSES ONLY.</p>					
SIZE		WIDTH		MULT		LBS/M		TEMPER	
FINISH				MATERIAL				SPEC No.	
SPEC No.				FIRST USED ON				SCALE	
DATE DRAWN				BY		CHKD		APVD	
31-Mar-09				TJK		4-8-09		4-8-09	
NAME				PART No.				REV	
PUSH-LITE SWITCHES, RoHS				PL_2_2_X SERIES				A	
PL_7_7_X SERIES									

# Mouser Electronics

Authorized Distributor

Click to View Pricing, Inventory, Delivery & Lifecycle Information:

## Switchcraft:

[PL106205](#) [PL212705](#) [PL102](#) [PL103205X](#) [PL103705X](#) [PL106205X](#) [PL106705X](#) [PL112205X](#) [PL112705X](#)  
[PL203205X](#) [PL206205X](#) [PL206705X](#) [PL212205X](#) [PL212705X](#) [PL103705](#) [PL106705](#) [PL206205](#) [PL212205](#) [PL202](#)  
[PL126205X](#) [PL126705X](#) [PL203705X](#) [PL226205X](#) [PL226705X](#)