

LOC	DATE	DESCRIPTION	DATE	BY	APP
B16	23.MAR.2017	ECR-17-001383		KD	RR
B17	14.APR.2017	ECR-17-008665		LZ	RR

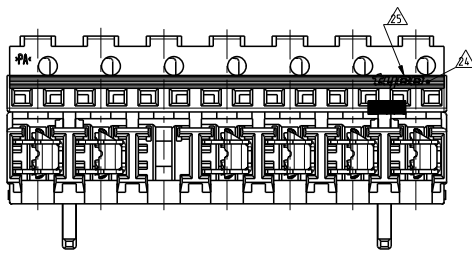
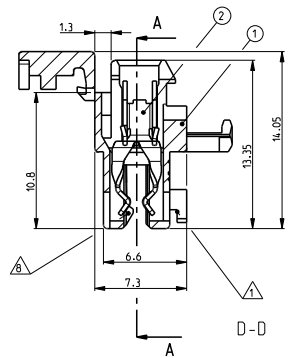
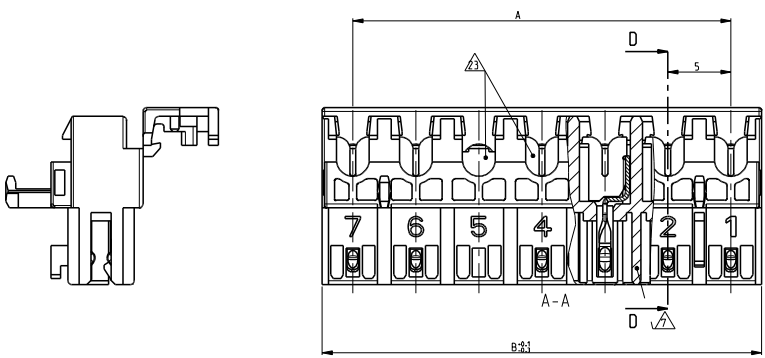
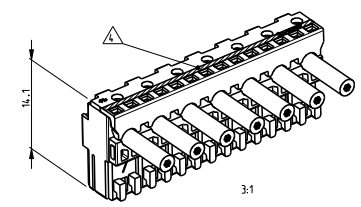
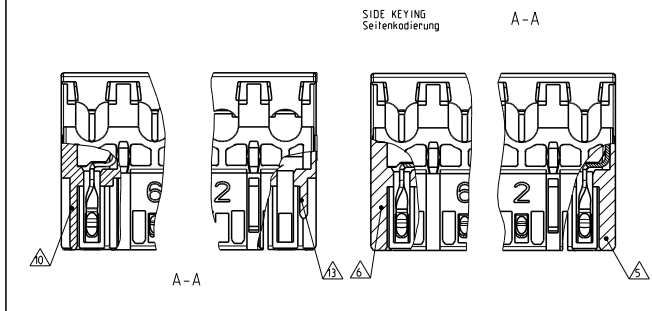
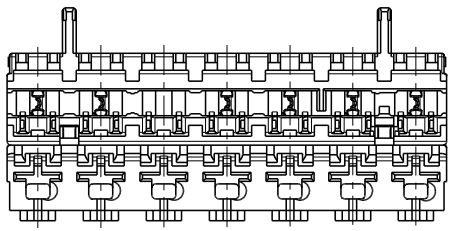

- △ SLOT FOR SIDE KEYING NARROW ON LAST CAVITY
- △ PRELIMINARY PART NOT RELEASED FOR PRODUCTION
- △ TE LOGO
- △ COLOUR MARKING IN THIS AREA. COLOUR SEE TABLE.
Farbmarkierung in diesem Bereich. Farbe siehe Tabelle.
- △ X...CAVITY LOADED WITH CONTACT
D...CAVITY WITHOUT CONTACT
X...Kammer mit Kontakt besetzt
D...Kammer ohne Kontakt
- △ INCLUSIVE COPPER CLADDING, SINGLE OR DOUBLE SIDED
Inklusive Kupferkaschierung, ein oder doppelseitig
- △ PCB PREFERABLY CHAMFERED
Leiterplatte vorzugsweise angefast
- △ SLOT FOR ADDITIONAL KEYING RIB BETWEEN CAVITY NO.
Schlitz fuer zusaezliche Kodierrippe zwischen Kammer Nr.
- △ SLOT FOR SIDE KEYING NARROW AND REDUCED, ON CAVITY NO.1
Schlitz fuer Seitenkodierung, eng und reduziert, bei Kammer Nr. 1
- △ SLOT FOR SIDE KEYING, ON LAST CAVITY
Schlitz fuer Seitenkodierung, bei letzter Kammer
- △ SLOT FOR SIDE KEYING, ON CAVITY NO. 1
Schlitz fuer Seitenkodierung, bei Kammer Nr. 1
- △ IEC 60695-2-11 / IEC 60335-1 GLOW WIRE TEST 750 °C WITHOUT FLAME
IEC 60695-2-11 / IEC 60335-1 Gluehdrahttest 750 °C ohne Flamme
- △ -
- △ SIDE KEYING, SMALL AND HALF, ON CAVITY NO. 1
Seitenkodierung, schmal und halb, bei Kammer Nr. 1
- △ -
- △ SIDE KEYING, SMALL, ON LAST CAVITY
- △ -
- △ LOCKING HOOK BETWEEN CAVITY NO. ...
Rasthaken zwischen Kammernummer ...
- △ ADDITIONAL KEYING RIB BETWEEN CAVITY NO.
Zusaezliche Kodierrippe zwischen Kammer Nr.
- △ SIDE KEYING, ON LAST CAVITY
Seitenkodierung, bei letzter Kammer
- △ SIDE KEYING, ON CAVITY NO. 1
Seitenkodierung, bei Kammer Nr. 1
- △ COLOUR MARKING ON TOP OF HOUSING OPTIONAL ON TERMINATION MACHINE
Farbmarkierung auf Gehaeuseoberseite optional an Verarbeitungsmaschine
- △ MATING PART: PCB ACCORDING SHEET 2 OF 2
3 Passender Gegenstecker: Leiterplatten siehe Blatt 2 von 2
- △ WIRE RANGE: 0.35-0.75 mm² ACCORDING TO APPLICATION SPEC 114-18996
Drabtrossenbereich: 0.35 - 0.75 mm²; siehe Verarbeitungsspezifikation Nr.114-18996.
- △ KEYING RIBS: CUTTING WITH TERMINATION MACHINE POSSIBLE
Kodierrippe: Schneiden auf der Verarbeitungsmaschine moeglich

POS.	PN Betell.-Nr.	DESCRIPTION Beschreibung	MATERIAL	COLOUR/FINISH Farbe/Oberflaeche
2	SEE TABLE	CONTACT	CuNiSi	TINNED/verzinkt
1	siehe Tabelle	HOUSING	PA6 GF △	NATURE/natur

THIS DRAWING IS A CONTROLLED DOCUMENT.

DESIGNER D. Atzmann	DATE 01NOV2005
CHECKER Ch. Schaubel	DATE 01NOV2005
APPROVER L. Kleinlercher	DATE 01NOV2005

TE Connectivity

AMP DUOPLUG POWER FEMALE CONNECTOR 2-9 POSITION (WITH PCB LOCKING)

STRT CASE CODE DRAWING NO. 00779 ©=174.0533

CUSTOMER DRAWING SCALE 5:1 SHEET 1 OF 3 14B17

**PCB LAYOUT
Leiterplattenanschluss**

LOC	DATE	REVISIONS
AI	-	DESCRIPTION
		DATE
		BY
		APPD

2 POSITION
2 polig

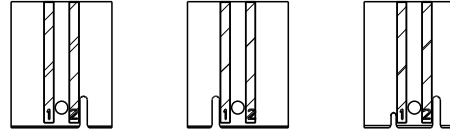

LAYOUT FOR CONNECTOR NO. 0-1740533-2 LAYOUT FOR CONNECTOR NO. 1-1740533-2 LAYOUT FOR CONNECTOR NO. 2-1740533-2

3 POSITION
3 polig

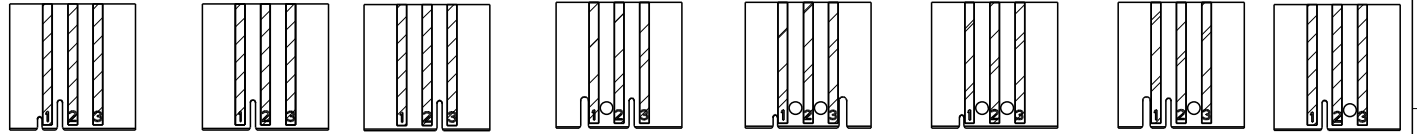

LAYOUT FOR CONNECTOR NO. 9-1740533-3 LAYOUT FOR CONNECTOR NO. 7-1740533-3 LAYOUT FOR CONNECTOR NO. 6-1740533-3 LAYOUT FOR CONNECTOR NO. 0-1740533-3 LAYOUT FOR CONNECTOR NO. 1-1740533-3 LAYOUT FOR CONNECTOR NO. 2-1740533-3 LAYOUT FOR CONNECTOR NO. 3-1740533-3 (W ITHOUT PAD 3) LAYOUT FOR CONNECTOR NO. 4-1740533-3 (W ITHOUT PAD 1)

4 POSITION
4 polig

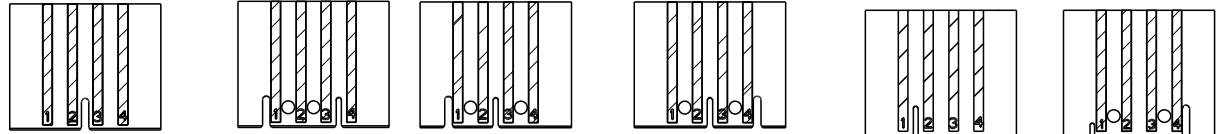

LAYOUT FOR CONNECTOR NO. 5-1740533-4 LAYOUT FOR CONNECTOR NO. 3-1740533-4 LAYOUT FOR CONNECTOR NO. 0-1740533-4 (W ITHOUT PAD 2) LAYOUT FOR CONNECTOR NO. 1-1740533-4 LAYOUT FOR CONNECTOR NO. 4-1740533-4 LAYOUT FOR CONNECTOR NO. 6-1740533-4

5 POSITION
5 polig

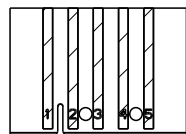

LAYOUT FOR CONNECTOR NO. 0-1740533-5

6 POSITION
6 polig

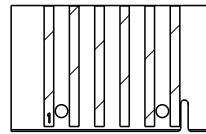

LAYOUT FOR CONNECTOR NO. 5-1740533-6

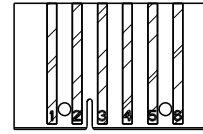

LAYOUT FOR CONNECTOR NO. 0-1740533-6 (W ITHOUT PAD 2/5/6) LAYOUT FOR CONNECTOR NO. 1-1740533-6 LAYOUT FOR CONNECTOR NO. 3-1740533-6 (W ITHOUT PAD 2)

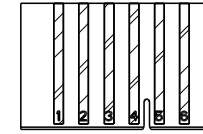

LAYOUT FOR CONNECTOR NO. 2-1740533-6

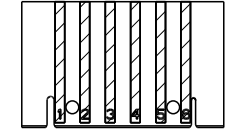

LAYOUT FOR CONNECTOR NO. 4-1740533-6

7 POSITION
7 polig

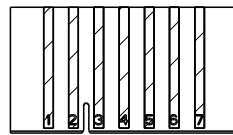

LAYOUT FOR CONNECTOR NO. 4-1740533-7

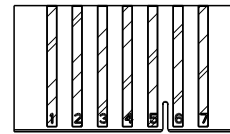

LAYOUT FOR CONNECTOR NO. 0-1740533-7

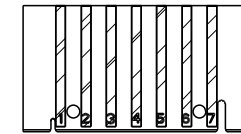

LAYOUT FOR CONNECTOR NO. 1-1740533-7

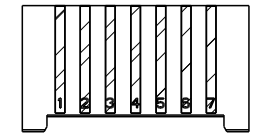

LAYOUT FOR CONNECTOR NO. 2-1740533-7

8 POSITION

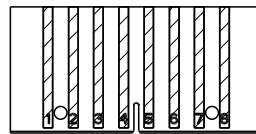

LAYOUT FOR CONNECTOR NO. 0-1740533-8

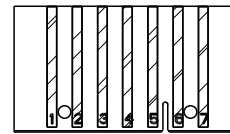

LAYOUT FOR CONNECTOR NO. 3-1740533-7

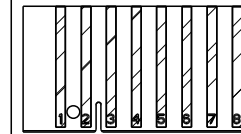

LAYOUT FOR CONNECTOR NO. 0-1740533-9 LAYOUT FOR CONNECTOR NO. 1-1740533-9 (W ITHOUT PAD 9)

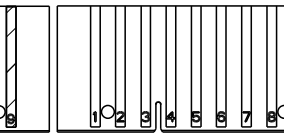

LAYOUT FOR CONNECTOR NO. 2-1740533-9 LAYOUT FOR CONNECTOR NO. 9 POSITION 9 polig

THIS DRAWING IS A CONTROLLED DOCUMENT.

DATE	01NOV2005	DESIGNED BY	J. Aitzmann
REV	01NOV2005	CHECKED BY	B. Schaubel
DATE	01NOV2005	APPROVED BY	J. Aitzmann

PRODUCT SPEC: AMP DUOPLUG POWER FEMALE CONNECTOR 2-9 POSITION (W ITH PCB LOCKING)

SCALE: 5:1 SHEET 2 OF 3

LOC	REV	DESCRIPTION	DATE	BY	APP
A1	1	SEE SHEET 1	-	-	-

PCB LAYOUT IN GENERAL
Leiterplattenanschluss allgemein

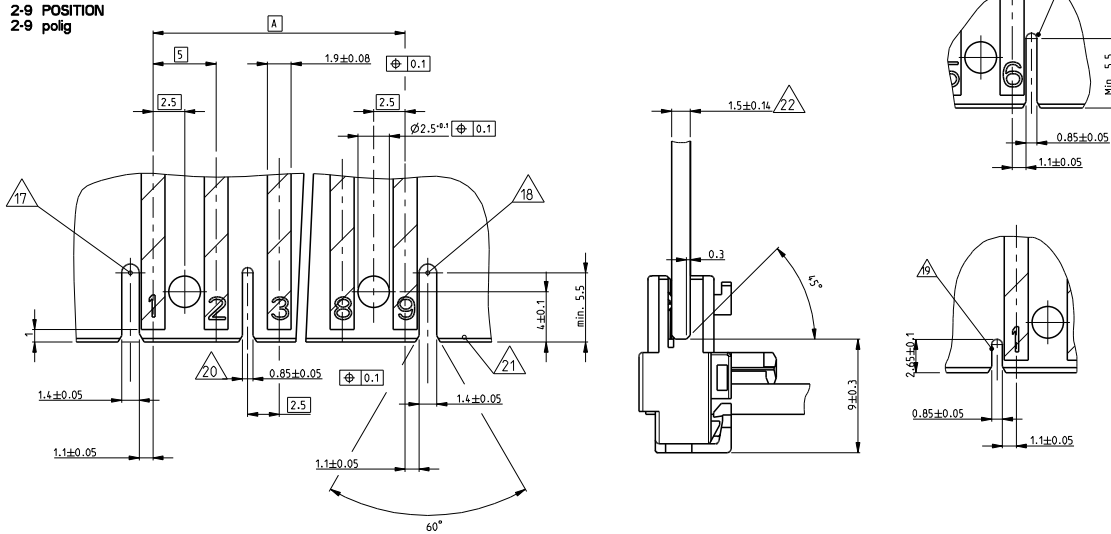

**PCB LAYOUT FOR VERSIONS WITHOUT KEYING RIBS/
 LOCKING HOOKS (E. G. PN 2-1740533-7)**
**Leiterplattenanschluss fuer Version ohne Kodierrippen/
 Rasthaken (z. B. Nr. 2-1740533-7)**

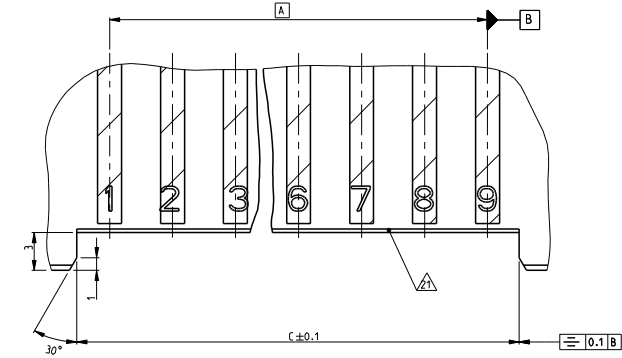

COLOUR/Farbe	9	8	7	6	5	4	3	2	1	POS. Polzahl	DIM A	DIM B	DIM C	KEYING	KEYING	KEYING	KEYING	KEYING	LOCKING HOOK	PN Bestell-Nr.
-	X	X	X	X	X	X	X	X	X	9	40	44.9	-	-	-	-	-	-	1/2 + 8/9	2-1740533-9
GREEN/gruen	0	X	X	X	X	X	X	X	X	9	40	44.9	-	-	-	-	-	-	1/2 + 8/9	1-1740533-9
GREEN/gruen	X	X	X	X	X	X	X	X	X	9	40	44.9	-	-	-	-	-	-	1/2 + 8/9	0-1740533-9
-		X	X	X	X	X	X	X	X	8	35	39.9	-	-	-	-	-	-	1/2 + 7/8	0-1740533-8
-		X	X	X	X	X	X	X	X	7	30	34.9	-	-	-	-	-	-	2/3	4-1740533-7
-	X	X	X	X	X	X	X	X	X	7	30	34.9	-	-	-	-	-	-	5/6	3-1740533-7
-		X	X	X	X	X	X	X	X	7	30	34.9	35.1	-	-	-	-	-	-	2-1740533-7
-		X	X	X	X	X	X	X	X	7	30	34.9	-	X	-	-	-	-	1/2 + 6/7	1-1740533-7
-		X	X	X	X	X	X	X	X	7	30	34.9	-	-	-	-	-	-	5/6	0-1740533-7
-		X	X	X	X	X	X	X	X	6	25	29.9	-	-	X	-	-	-	1/2 + 5/6	4-1740533-6
BLACK/schwarz		X	X	X	X	0	X	X	X	6	25	29.9	-	-	-	-	-	-	1/2 + 5/6	3-1740533-6
-		X	X	X	X	X	X	X	X	6	25	29.9	-	-	-	-	-	-	-	2-1740533-6
BLACK/schwarz		X	X	X	X	X	X	X	X	6	25	29.9	-	-	-	-	-	-	1/2 + 5/6	1-1740533-6
BLACK/schwarz	0	0	X	X	0	X	X	X	X	6	25	29.9	-	-	-	-	-	-	1/2 + 5/6	0-1740533-6
-		X	X	X	X	X	X	X	X	5	20	24.95	-	-	-	-	-	-	2/3 + 4/5	0-1740533-5
-		X	X	X	X	X	X	X	X	4	15	19.9	-	X	-	-	-	-	1/2 + 3/4	6-1740533-4
-		X	X	X	X	X	X	X	X	4	15	19.9	-	-	-	-	-	-	2/3	5-1740533-4
-		X	X	X	X	X	X	X	X	4	15	19.9	-	-	-	-	-	-	1/2	4-1740533-4
BROWN/braun		X	X	X	X	X	X	X	X	4	15	19.9	-	-	-	-	-	-	3/4	3-1740533-4
BROWN/braun		X	X	X	X	X	X	X	X	4	15	19.9	-	-	-	-	-	-	2/3	2-1740533-4
BLUE/blau		X	X	X	X	X	X	X	X	4	15	19.9	-	-	-	-	-	-	1/2 + 3/4	1-1740533-4
BROWN/braun		X	X	0	X	X	X	X	X	4	15	19.9	-	-	-	-	-	-	1/2 + 3/4	0-1740533-4
BLUE/blau		X	X	X	X	X	X	X	X	3	10	14.9	-	X	-	-	-	-	9-1740533-3	
-		X	X	X	X	X	X	X	X	3	10	14.9	-	X	-	-	-	-	1/2 + 2/3	8-1740533-3
-		X	X	X	X	X	X	X	X	3	10	14.9	-	-	-	-	-	-	1/2	7-1740533-3
-		X	X	X	X	X	X	X	X	3	10	14.9	-	-	-	-	-	-	2/3	6-1740533-3
BLACK/Schwarz		X	X	0	X	X	X	X	X	3	10	14.9	-	-	-	-	-	-	1/2	5-1740533-3
BLACK/schwarz	0	X	X	X	X	X	X	X	X	3	10	14.9	-	-	-	-	-	-	2/3	4-1740533-3
-		X	X	X	X	X	X	X	X	3	10	14.9	-	X	-	-	-	-	1/2 + 2/3	2-1740533-3
-		X	X	X	X	X	X	X	X	3	10	14.9	-	-	-	-	-	-	1/2 + 2/3	1-1740533-3
BLACK/schwarz		X	X	X	X	X	X	X	X	3	10	14.9	-	-	-	-	-	-	2/3	0-1740533-3
-		X	X	X	X	X	X	X	X	2	5	9.9	-	X	-	-	-	-	1/2	2-1740533-2
RED/rot		X	X	X	X	X	X	X	X	2	5	9.9	-	-	-	-	-	-	1/2	1-1740533-2
GREEN/gruen		X	X	X	X	X	X	X	X	2	5	9.9	-	-	-	-	-	-	1/2	0-1740533-2

COLOUR	9	8	7	6	5	4	3	2	1	POS	DIM A	DIM B	DIM C	KEYING	KEYING	KEYING	KEYING	KEYING	LOCKING HOOK	PART NO
BLACK				X	X	X	X	X	X	6	25	29.9	-	X	-	-	-	-	1/2 + 5/6	5-1740533-6

THIS DRAWING IS A CONTROLLED DOCUMENT. T&E CONNECTIVITY INC. SUDHAKAR 280C12013
 DIMENSIONAL UNIT: mm. DATE: 08/2013. PRODUCT SPEC: AMP DUOPLUG POWER FEMALE CONNECTOR 2-9 POSITION (WITH PCB LOCKING).
 MATERIAL: SEE TABLE. FINISH: SEE TABLE. HEIGHT: 11.18926. SCALE: 5:1. SHEET: 3 OF 3. DRAWING NO: 00779. PART NO: 1740533.

Mouser Electronics

Authorized Distributor

Click to View Pricing, Inventory, Delivery & Lifecycle Information:

[TE Connectivity:](#)

[1-1740533-2](#)