



60×60×25 mm

San Ace 60 9R type

General Specifications

- Material Frame: Plastic (Flammability: UL 94V-0), Impeller: Plastic (Flammability: UL 94V-1)
- Expected life See the table below. (L10 life: 90% survival rate for continuous operation in free air at 60°C, rated voltage)
- Motor protection function Locked rotor burnout protection, Reverse polarity protection
For details, please refer to p. 529.
- Dielectric strength 50/60 Hz, 500 VAC, for 1 minute (between lead wire conductors and frame)
- Insulation resistance 10 MΩ or more with a 500 VDC megger (between lead wire conductors and frame)
- Sound pressure level (SPL) At 1 m away from the air inlet
- Storage temperature -30 to +70°C (Non-condensing)
- Lead wire ⊕Red ⊖Black or Blue (Sensor) Yellow
- Mass 90 g

Specifications

The models listed below **have ribs and pulse sensors.** For models without ribs, append "1" to the end of model numbers.

Model no.	Rated voltage [V]	Operating voltage range [V]	Rated current [A]	Rated input [W]	Rated speed [min ⁻¹]	Max. airflow [m ³ /min] [CFM]	Max. static pressure [Pa] [inchH ₂ O]	SPL [dB (A)]	Operating temperature [°C]	Expected life [h]		
109R0605H401	5	4.5 to 5.5	0.34	1.7	3800	0.53 18.7	40.2 0.161	28	-20 to +70	60000/60°C		
109R0605F401			0.2	1.0	3200	0.44 15.5	29.4 0.118	24	-20 to +60			
109R0605M401			0.13	0.65	2600	0.36 12.7	19.6 0.079	20	-20 to +70			
109R0612J401	12	10.8 to 13.2	0.47	5.64	7600	1.06 37.1	155.0 0.622	44	-20 to +60	40000/60°C		
109R0612G401		10.2 to 13.8	0.24	2.88	5600	0.78 27.5	87.3 0.351	39	-20 to +70			
109R0612D401			0.21	2.52	5150	0.72 25.4	73.5 0.295	37				
109R0612S401			0.17	2.04	4600	0.65 23.0	56.8 0.228	33				
109R0612H401		6 to 13.8	6 to 13.8	0.11	1.32	3800	0.53 18.7	40.1 0.161	28		-20 to +70	
109R0612F401				0.09	1.08	3200	0.44 15.5	29.4 0.118	24			
109R0612M401				0.06	0.72	2600	0.36 12.7	19.6 0.079	20			
109R0624J401		24	21.6 to 26.4	0.24	5.76	7600	1.06 37.1	155.0 0.622	44		-20 to +60	40000/60°C
109R0624G401			20.4 to 27.6	0.13	3.12	5600	0.78 27.5	87.3 0.351	39		-20 to +70	
109R0624D401	0.12			2.88	5150	0.72 25.4	73.5 0.295	37				
109R0624S401	0.08			1.92	4600	0.65 23.0	56.8 0.228	33				
109R0624H401	12 to 27.6		12 to 27.6	0.06	1.44	3800	0.53 18.7	40.2 0.161	28	-20 to +70		
109R0624F401				0.05	1.2	3200	0.44 15.5	29.4 0.118	24			
109R0624M401				0.04	0.96	2600	0.36 12.7	19.6 0.079	20			
109R0648J401	48	43.2 to 52.8	0.12	5.76	7600	1.06 37.1	155.0 0.622	44	-20 to +60	40000/60°C		
109R0648G401		43 to 53	0.07	3.36	5600	0.78 27.5	87.3 0.351	39	-20 to +70			
109R0648H401			40 to 53	0.04	1.92	3800	0.53 18.7	40.2 0.161			28	

Other sensor specifications are available as options. Refer to the index (p. 545).

Airflow - Static Pressure Characteristics

109R0605H401 With pulse sensor

Operating voltage range

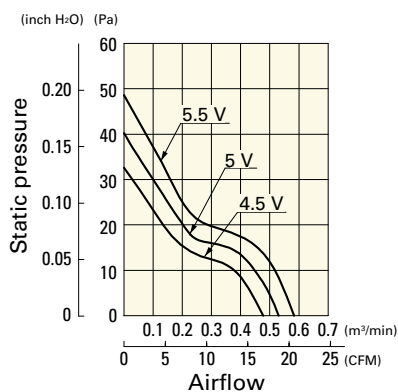

109R0605F401 With pulse sensor

Operating voltage range

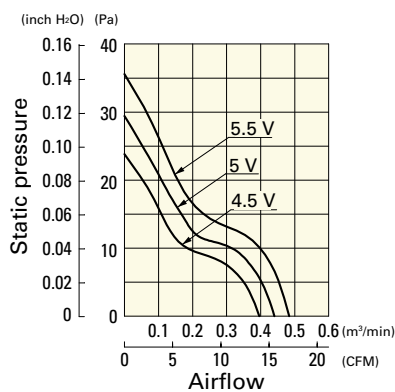

109R0605M401 With pulse sensor

Operating voltage range

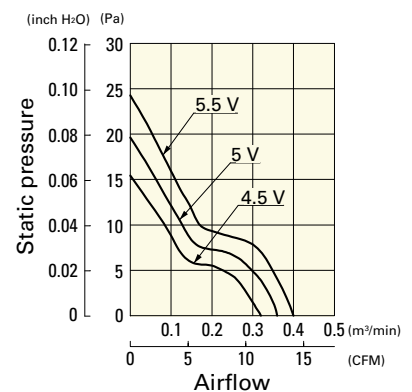

Airflow - Static Pressure Characteristics

109R0612J401 With pulse sensor

Operating voltage range

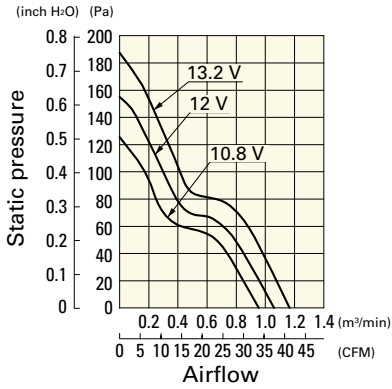

109R0612G401 With pulse sensor

Operating voltage range

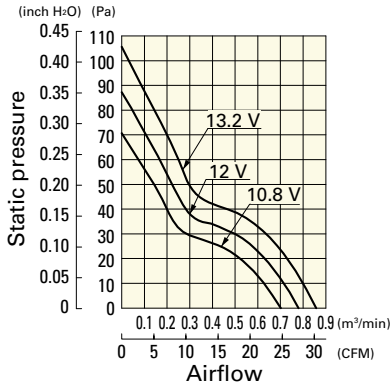

109R0612D401 With pulse sensor

Operating voltage range

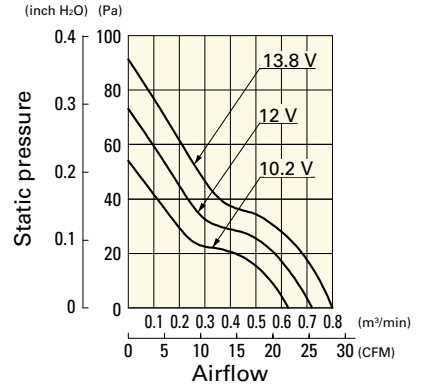

109R0612S401 With pulse sensor

Operating voltage range

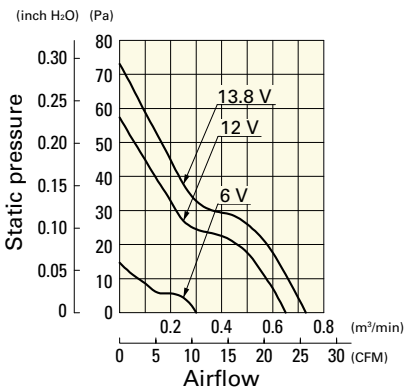

109R0612H401 With pulse sensor

Operating voltage range

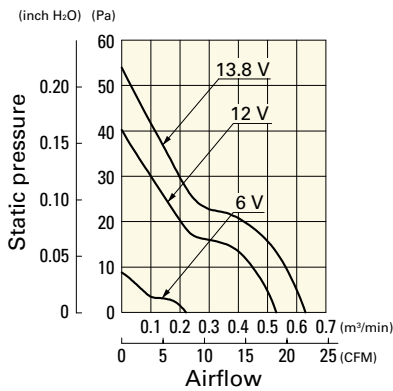

109R0612F401 With pulse sensor

Operating voltage range

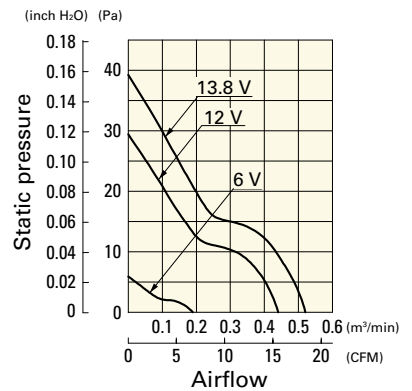

109R0612M401 With pulse sensor

Operating voltage range

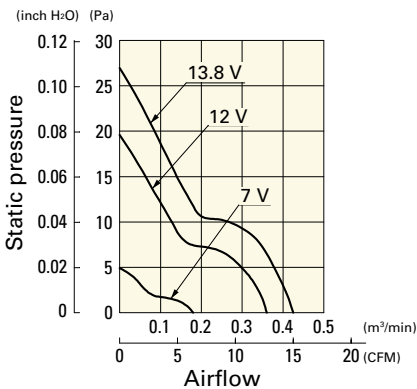

109R0624J401 With pulse sensor

Operating voltage range

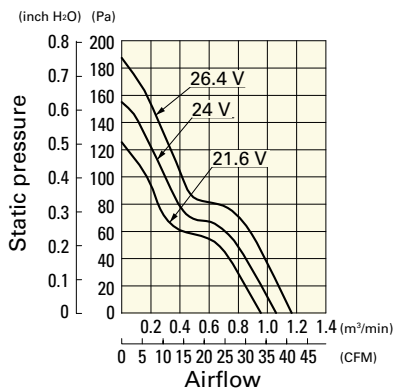

109R0624G401 With pulse sensor

Operating voltage range

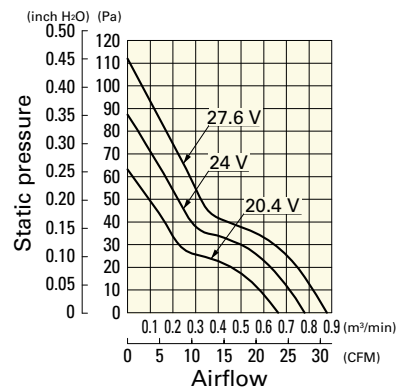

109R0624D401 With pulse sensor

Operating voltage range

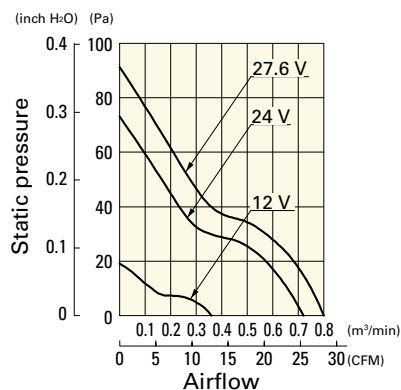

109R0624S401 With pulse sensor

Operating voltage range

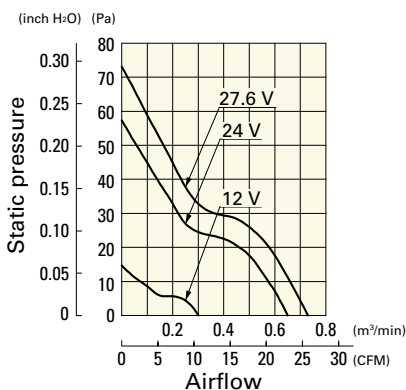

109R0624H401 With pulse sensor

Operating voltage range

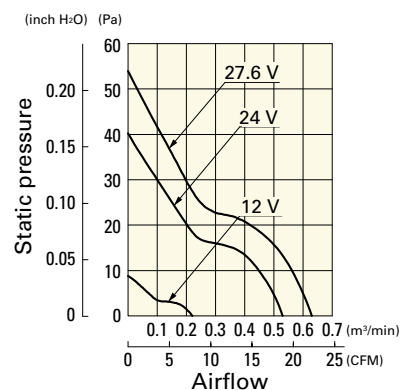

Airflow - Static Pressure Characteristics

109R0624F401 With pulse sensor

Operating voltage range

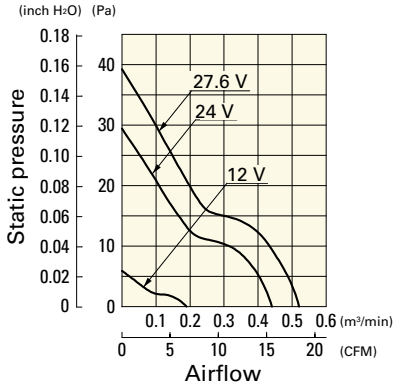

109R0624M401 With pulse sensor

Operating voltage range

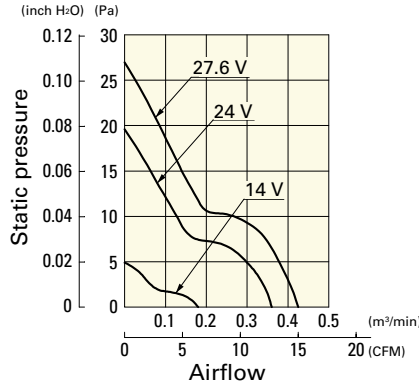

109R0648J401 With pulse sensor

Operating voltage range

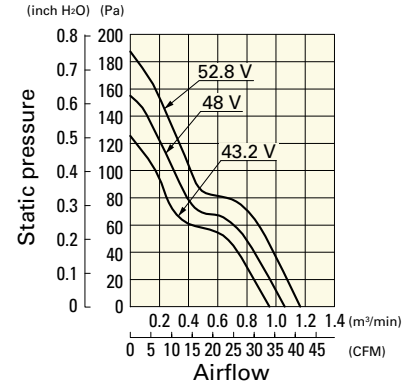

109R0648G401 With pulse sensor

Operating voltage range

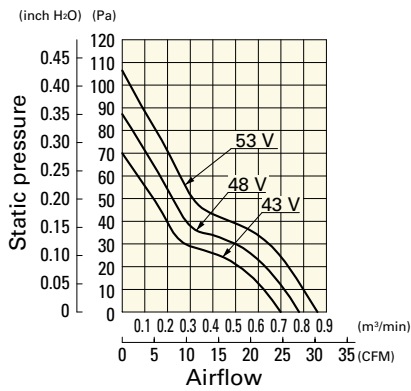

109R0648H401 With pulse sensor

Operating voltage range

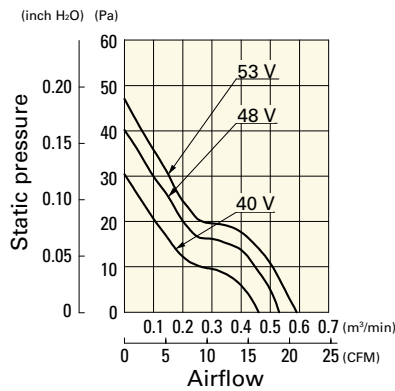

Dimensions (unit: mm) (With ribs)

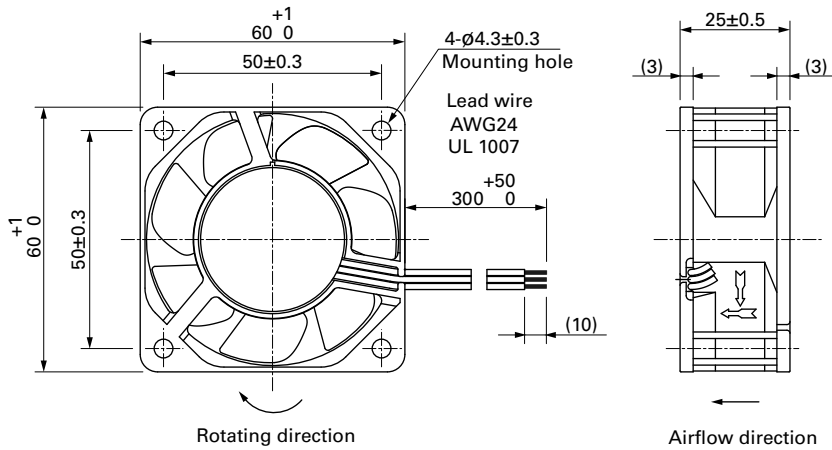

Mouser Electronics

Authorized Distributor

Click to View Pricing, Inventory, Delivery & Lifecycle Information:

Sanyo Denki:

[109R0605M4021](#) [109R0612F402](#) [109R0624F402](#) [109R0624J401](#) [109R0624M4011](#) [109R0624S4021](#)
[109R0605H4011](#) [109R0605M4011](#) [109R0612D4011](#) [109R0612G4011](#) [109R0612H4011](#) [109R0612M4011](#)
[109R0612S4011](#) [109R0605H401](#) [109R0605M401](#) [109R0612D401](#) [109R0624D401](#) [109R0648H401](#) [109R0648J401](#)
[109R0605F402](#) [109R0605M402](#) [109R0612D402](#) [109R0612J402](#) [109R0612S402](#) [109R0624S402](#) [109R0648G402](#)
[109R0605H4021](#) [109R0612G4021](#) [109R0624G4021](#) [109R0612J4021](#) [109R0624G402](#) [109R0624G401](#)
[109R0648H4011](#) [109R0605F401](#) [109R0624J4011](#) [109R0648G401](#) [109R0624F401](#) [109R0612S4021](#)
[109R0648H4021](#) [109R0624F4021](#) [109R0624H402](#) [109R0612G402](#) [109R0624M401](#) [109R0612H4021](#)
[109R0605H402](#) [109R0612M4021](#) [109R0612M402](#) [109R0612H402](#) [109R0612F4021](#) [109R0612G401](#)
[109R0624H4021](#) [109R0648H402](#) [109R0612J401](#) [109R0624S401](#) [109R0612S401](#) [109R0612J4011](#)
[109R0624D4011](#) [109R0624H4011](#) [109R0624H401](#) [109R0612H401](#) [109R0612M401](#) [109R0624F4011](#)
[109R0612F401](#) [109R0624G4011](#) [109R0648J4011](#) [109R0648G4011](#) [109R0612F4011](#) [109R0648G4D011](#)
[109R0648H4D01](#) [109R0624S4D01](#) [109R0612J4D011](#) [109R0624S4D011](#) [109R0624M402](#) [109R0624H4D011](#)
[109R0624J402](#) [109R0624H4D01](#) [109R0624G4D01](#) [109R0648H4D011](#) [109R0648J402](#) [109R0648J4021](#)
[109R0648J4D01](#) [109R0612S4D01](#) [109R0648G4D01](#) [109R0612F4D011](#) [109R0648G4021](#) [109R0605F4021](#)
[109R0612F4D01](#) [109R0624M4D01](#) [109R0624M4D011](#) [109R0612G4D01](#) [109R0612G4D011](#) [109R0624D402](#)
[109R0624D4D01](#) [109R0624G4D011](#) [109R0612M4D01](#) [109R0612S4D011](#) [109R0624M4021](#) [109R0624F4D01](#)
[109R0612M4D011](#) [109R0624F4D011](#)