

# Waterproof Connectors for Outdoor Use

## HR41 Series



### ■ Features

#### 1. Waterproof connector designed for outdoor use

Light weight, waterproof connector designed to withstand outdoor environments. The weatherproof plastic shell provides the strength needed to withstand the elements.

#### 2. Waterproof structure

Supports IP67 and IP68 ratings while in the mated condition. (Ratings explained below\*)

\*IP67: Submerged in 1m for 30 minutes

\*IP68: Submerged in 2m for 14 days

#### 3. Bayonet locking system

The bayonet system is user-friendly and is simple enough to facilitate blind mating in dark or low light areas. (Fig.1)

#### 4. Easy field assembly

User-friendly operations and assembly allow this connector to be wired in the field.

#### 5. Compatible with commercial tooling

The crimp contact is compatible with commercial crimp tools that meet the JIS C 9711 standard.

#### 6. Sequential Contact (Fig.3)

3 position: 2 step sequence

5 position: 3 step sequence

#### 7. Designed to accommodate hot swapping (5 position plug)

Hot swapping condition : AC 20A, AC 300V (50 swap cycles).

This testing method conforms to UL1977 standards.

#### 8. Surge resistant

The walled structure isolates each contact and provides enough insulation to protect against 15kV surges caused by lightning.

#### 9. Gold plated contact area

Gold plating is applied to the interface contact area to increase the reliability of its connection.

#### 10. Safety standard certified

UL certification and TÜV certification have been achieved.

### Bayonet Lock

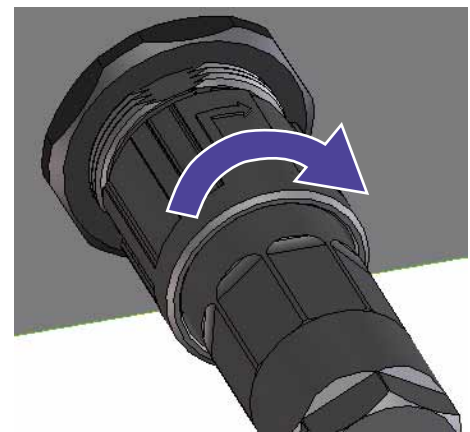
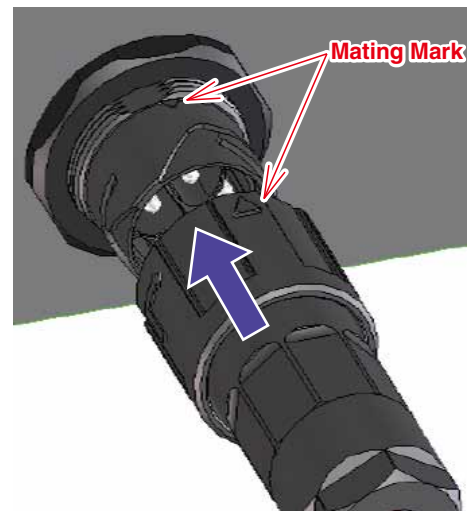

Fig. 1

### Structure allowing GND to make contact first (3 position)

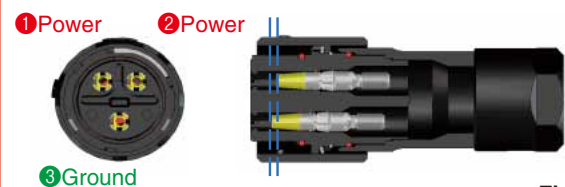

Fig. 2

### Sequential Contact mating (5 position)

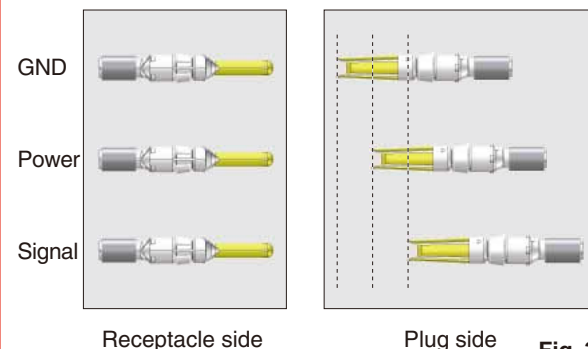

Fig. 3

## Product Specifications

Ratings	Current Rating (Note 3)	24A (Ambient Temperature 25°C)	Operating Temperature Range	-40 to +105°C (Note 1)
	Voltage Rating	AC 1000V, DC 1000V	Storage Temperature Range	-10 to +60°C
UL, TÜV	Current Rating (Note 3)	20A (5 position, includes 4 position excluding ground are use)	Operating Temperature Range	-40 to +65°C (Note 1)
	Voltage Rating	AC 600V, DC 600V	Storage Temperature Range	-10 to +60°C

Note 1 : Including temperature rise due to current carrying.

Items	Specifications	Conditions
1. Contact resistance	Maximum of 2mΩ	Measured at DC 1A
2. Insulation resistance	Minimum of 5,000MΩ	Measured at DC 500V
3. Withstand voltage	No flashover or breakdown	3 pos. : Apply AC 4,260V for 1 minute 5 pos. : Apply AC 2,200V for 1 minute
4. Vibration resistance	No electrical discontinuity of 10μs or more	10 cycles in 3 axial directions at a frequency of 10 - 500 - 10Hz, half amplitude 0.75mm and 11 min/cycle
5. Shock resistance	No electrical discontinuity of 10μs or more	Acceleration 490m/s <sup>2</sup> , duration 11ms, half-sine wave, 3 times each for 3 axial directions
6. Durability	Contact resistance: Maximum of 4mΩ	200 mating cycles
7. Temperature cycles	Insulation resistance: Maximum of 5,000MΩ	5 cycles of (-55°C for 30min → ambient temp for 2 to 3 minutes → 85°C for 30min → ambient temp for 2 to 3 minutes)
8. Salt water spray	Functionality should not be damaged.	Spray 5% concentration salt water for 1,000 hours in mated connector condition.
9. Moisture resistance	Insulation resistance Minimum of 50MΩ (high humidity) Minimum of 500MΩ (dry)	At temperature 40°C, humidity 90 to 95%, for 96 hours
10. Water resistance	No water intrusion into connector inside	Left submerged in water in mated condition at depth of 2m for 14 days.

Depending on the structure and use of the cable, cable clamping force and cable stress, the waterproof performance may differ from what is noted above. Please check the performance before using the connector.

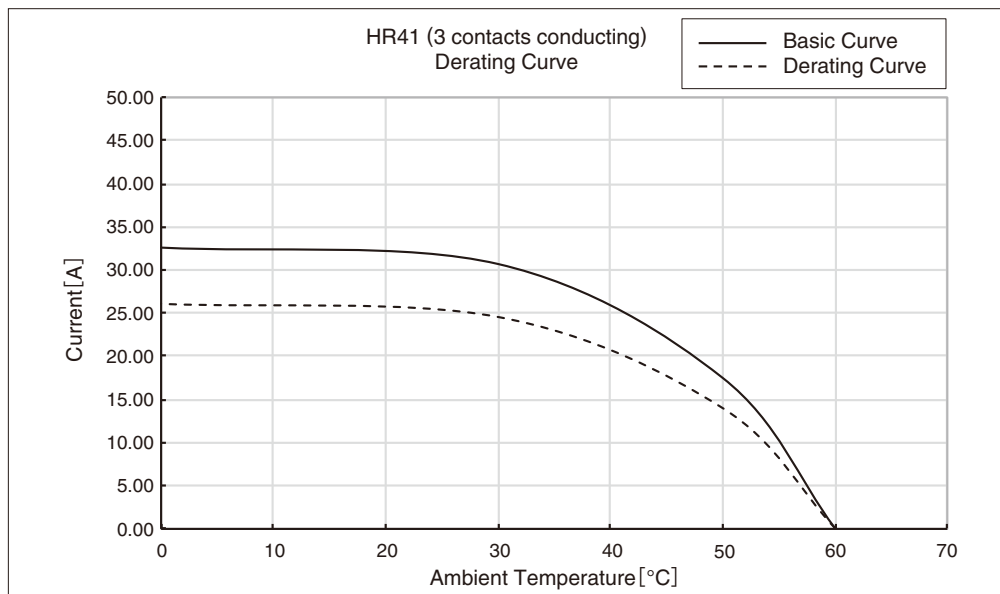

Note 2 : The derating curve is derived from the basic curve multiplied by the derating factor of 0.8.

Note 3 : The value of rated current varies with the ambient temperature. It is recommended to use the product within the derating curve zone.

When using a UL or TÜV approved product, please use the product within the specified range as well as the derating curve area.

Note 4 : The measurement method of the derating curve is shown below.

- Test specimen : This product, unused prior to testing.
- Test cable conductor cross sectional area : 5.5mm<sup>2</sup>
- Test condition : Power supplied while the specimen is in a stationary state and then measured.

## Materials / Finish

Component	Materials	Finish	UL standard (noncombustible)
Insulator	Polyamide resin, PBT resin	—————	UL94V-0
Contact	Copper alloy	Partially gold plated	—————
O-ring, gasket	Silicon rubber	—————	—————

## ■ Product Number Structure

Refer to the chart below when determining the product specifications from the product number.  
Please select from the product numbers listed in this catalog when placing orders.

### ● Connector

**HR41 - 25 W B P A - 3 S C (\*\*)**

①
②
③
④
⑤
⑥
⑦
⑧
⑨
⑩

### ● Crimp Contact

**HR41 - S C - 1 2 1 (\*\*)**

①
⑧
⑨
⑪
⑫
⑬
⑩

① Series name HR41	⑧ Shape of contact S : Female contact P : Male contact
② Shell size : 25	⑨ Contact wiring type C : Crimp
③ Specialty W : Waterproof type	⑩ Additional product specifications will be identified by the addition of (01), (02)...etc. as needed.
④ Lock mechanism B: Bayonet lock	⑪ Form of the contact 1 : Loose piece contacts
⑤ Shell type P : Plug R : Receptacle J : Jack	⑫ Shape 2 : Denotes the compatible wire gauge and will be identified by the use of 1, 2, 3 etc.
⑥ Serial symbol	⑬ Plating of the contact area 1 : Gold plated
⑦ Number of contact : 3, 5	

## ◆ Diagram of Connector Mating Combinations

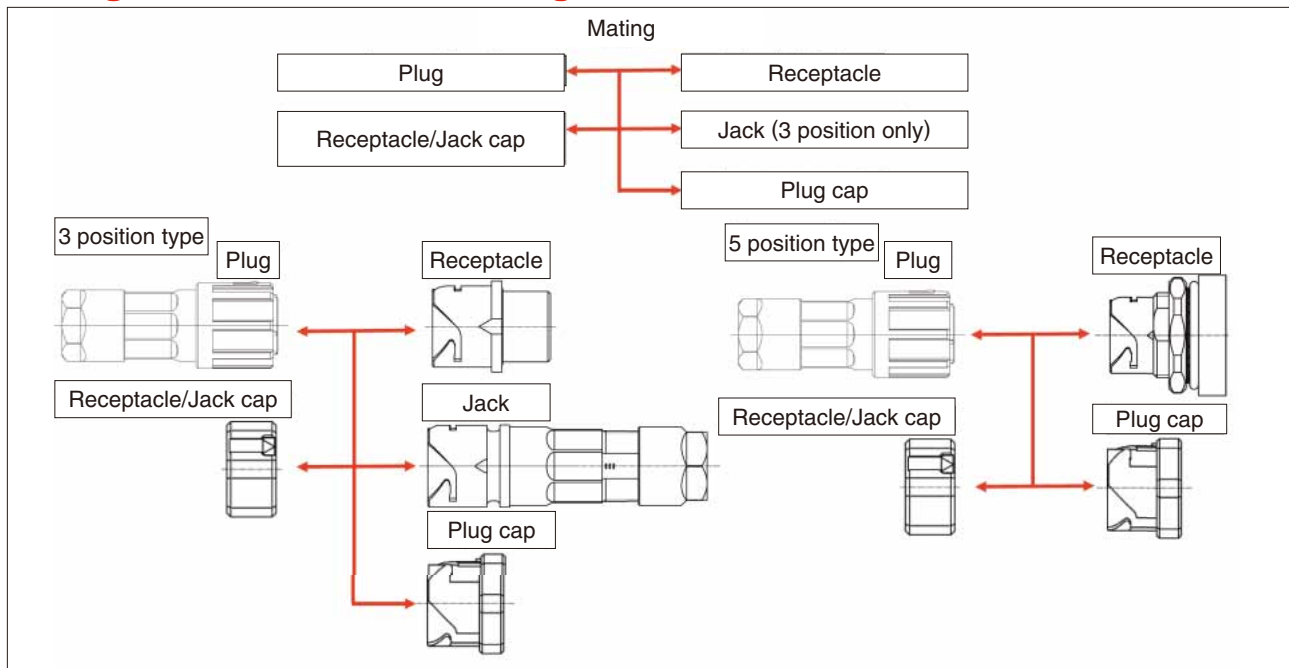

### ● Connector

Plug	Receptacle	Jack
HR41-25WBPD-3SC	HR41-25WBR-3PC	HR41-25WBJB-3PC
HR41-25WBPE-3SC		HR41-25WBPF-3PC
HR41-25WBPF-3SC		
HR41-25WBP-5SC	HR41-25WBRA-5PC	

### ● Plug cap

Plug	Cap
HR41-25WBPD-3SC	HR41-25WBP-C
HR41-25WBPE-3SC	
HR41-25WBPF-3SC	
HR41-25WBP-5SC	
HR41-25WBP-5SC	

### ● Receptacle/Jack cap

Receptacle	Cap
HR41-25WBR-3PC	HR41-25WBR-C
HR41-25WBRA-5PC	
HR41-25WBJB-3PC	
HR41-25WBPF-3PC	
HR41-25WBPF-3PC	

## ◆ Combination of Applicable Crimp Contacts

Plug	Crimp contact
HR41-25WBPD-3SC	HR41-SC-111
HR41-25WBPE-3SC	HR41-SC-121
HR41-25WBPF-3SC	HR41-SC-141
HR41-25WBP-5SC	HR41-SC-151

Receptacle	Crimp contact
HR41-25WBR-3PC	HR41-PC-111
	HR41-PC-121
HR41-25WBRA-5PC	HR41-PC-151

Jack	Crimp contact
HR41-25WBJB-3PC	HR41-PC-111
HR41-25WBPF-3PC	HR41-PC-121

### ■ 3 Position Type

#### ● Receptacle (Panel mount version)

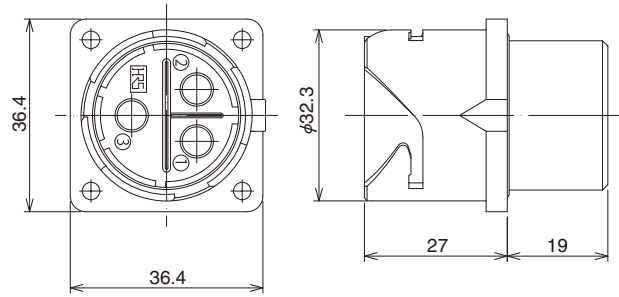

Part No.	HRS No.	No. of contacts
HR41-25WBR-3PC	141-0006-0	3

Note : The above products can be mated with male contacts.

#### ● Male contacts

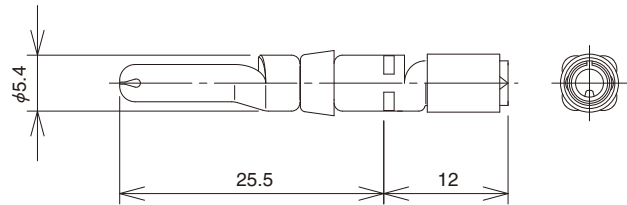

Type	Part No.	HRS No.	Gold Plating Thickness in Contact Area	Applicable Cable (should satisfy requirements of ①, ② and ③)
Loose contacts	HR41-PC-111	141-0002-0	0.2μm	① Conductor cross section 3.3 to 5.5mm <sup>2</sup> ② Conductor outer dia. Max of φ3.1 ③ Jacket outer dia. Max of φ6 (10 to 12 AWG)
	HR41-PC-111(01)	141-0002-0 01	0.76μm	
	HR41-PC-121	141-0004-5	0.2μm	① Conductor cross section 1.3 to 2.5mm <sup>2</sup> ② Conductor outer dia. Max of φ2.0 ③ Jacket outer dia. Max of φ6 (14 to 16 AWG)
	HR41-PC-121(01)	141-0004-5 01	0.76μm	

3 pieces per pack

●Jack

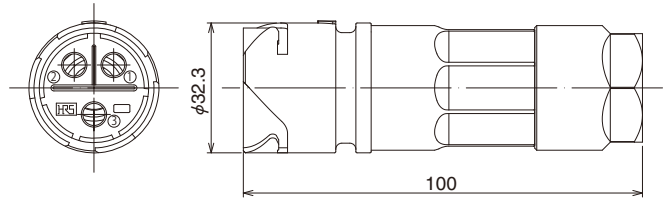

Part No.	HRS No.	No. of contacts	Applicable cable	Remarks
HR41-25WBJB-3PC	141-0017-7 00	3	$\phi 11.8 \pm 0.4$	—
HR41-25WBJF-3PC	141-0019-2 00		$\phi 13.5 \pm 0.7$	—

Note : The above products can be mated with male contacts.

●Male contact

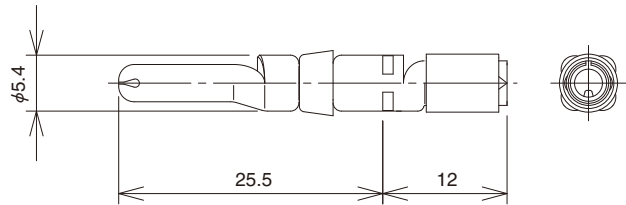

Type	Part No.	HRS No.	Gold Plating Thickness in Contact Area	Applicable Cable (should satisfy requirements of ①, ② and ③)
Loose contact	HR41-PC-111	141-0002-0	0.2 $\mu$ m	① Conductor cross section 3.3 to 5.5mm <sup>2</sup> ② Conductor outer dia. Max of $\phi 3.1$ ③ Jacket outer dia. Max of $\phi 6$ (10 to 12 AWG)
	HR41-PC-111(01)	141-0002-0 01	0.76 $\mu$ m	
	HR41-PC-121	141-0004-5	0.2 $\mu$ m	① Conductor cross section 1.3 to 2.5mm <sup>2</sup> ② Conductor outer dia. Max of $\phi 2.0$ ③ Jacket outer dia. Max of $\phi 6$ (14 to 16 AWG)
	HR41-PC-121(01)	141-0004-5 01	0.76 $\mu$ m	

3 pieces per pack

● Plug

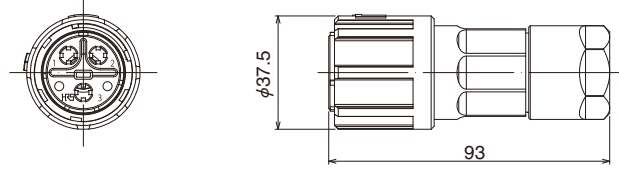

Part No.	HRS No.	No. of contacts	Applicable Cables	Remarks
HR41-25WBPD-3SC	141-0023-0	3	$\phi 9 \pm 0.6$	2 step sequence
HR41-25WBPE-3SC	141-0024-2		$\phi 10.1 \pm 0.6$	
HR41-25WBPF-3SC	141-0026-8		$\phi 13.5 \pm 0.7$	

Note : The above products can be mated with female contacts.

● Female contacts

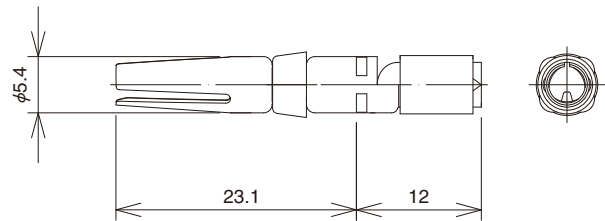

Type	Part No.	HRS No.	Gold Plating Thickness in Contact Area	Applicable Cable (should satisfy requirements of ①, ② and ③)
Loose contacts	HR41-SC-111	141-0001-7	0.2 $\mu$ m	① Conductor cross section 3.3 to 5.5mm <sup>2</sup> ② Conductor outer dia. Max of $\phi 3.1$ ③ Jacket outer dia. Max of $\phi 6$ (10 to 12 AWG)
	HR41-SC-111(01)	141-0001-7 01	0.76 $\mu$ m	
	HR41-SC-121	141-0003-2	0.2 $\mu$ m	① Conductor cross section 1.3 to 2.5mm <sup>2</sup> ② Conductor outer dia. Max of $\phi 2.0$ ③ Jacket outer dia. Max of $\phi 6$ (14 to 16 AWG)
	HR41-SC-121(01)	141-0003-2 01	0.76 $\mu$ m	
	HR41-SC-141	141-0008-6	0.2 $\mu$ m	① Conductor cross section 5.5 to 6.5mm <sup>2</sup> ② Conductor outer dia. Max of $\phi 3.4$ ③ Jacket outer dia. Max of $\phi 6$ (10 AWG)
	HR41-SC-141(01)	141-0008-6 01	0.76 $\mu$ m	

3 pieces per pack

Note : The HR41-SC-151, HR41-SC-111, HR41-SC-121 and HR41-SC-141 all utilize different contact structures and cannot be used in the same housing at the same time.



## ■ 5 Position Type

### ● Nut-Fastened, Back-Mount Type

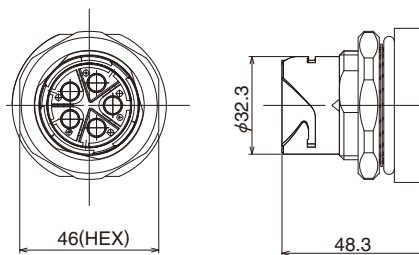

Part No.	HRS No.	No. of contacts
HR41-25WBRA-5PC	141-0010-8	5

Note : Part noted above requires all male contacts.

### ● Male Contact

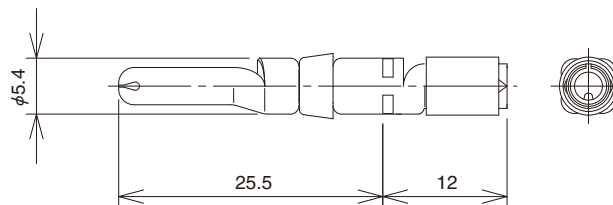

Type	Part No.	HRS No.	Gold Plating Thickness in Contact Area	Applicable Cable (should satisfy requirements of ①, ② and ③)
Loose contacts	HR41-PC-151	141-0012-3	0.2μm	① Conductor cross section 0.75 to 2.5mm <sup>2</sup> ② Conductor outer dia. Max of φ2.4 ③ Jacket outer dia. Max of φ6 (14 to 18 AWG)

5 pieces per pack

● Plug

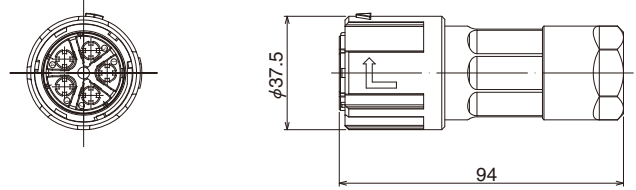

Part No.	HRS No.	No. of contacts	Applicable Cables	Remarks
HR41-25WBP-5SC	141-0009-9	5	$\phi 11 \pm 0.3$	3 step sequence

Note : The above product can be mated with female contacts.

● Female Contact

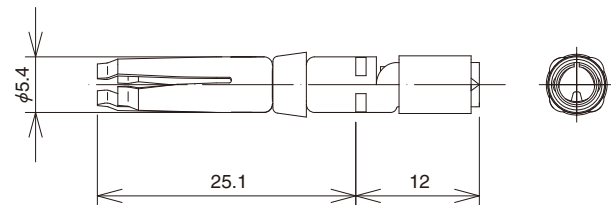

Type	Part No.	HRS No.	Gold Plating Thickness in Contact Area	Applicable Cable (should satisfy requirements of ①, ② and ③)
Loose contacts	HR41-SC-151	141-0011-0	0.2 $\mu$ m	① Conductor cross section 0.75 to 2.5mm <sup>2</sup> ② Conductor outer dia. Max of $\phi 2.4$ ③ Jacket outer dia. Max of $\phi 6$ (14 to 18 AWG)

5 pieces per pack

Note : The HR41-SC-151, HR41-SC-111, HR41-SC-121 and HR41-SC-141 all utilize different contact structures and cannot be used in the same housing at the same time.



■ Cap

● Plug cap

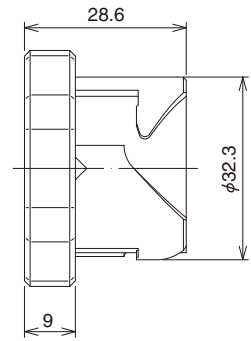
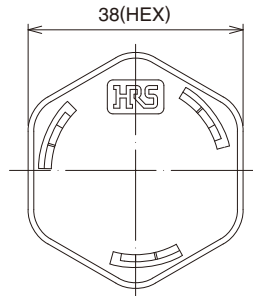

Part No.	HRS No.	Applicable Connectors
HR41-25WBP-C	141-0021-4	HR41-25WBPD-3SC HR41-25WBPE-3SC HR41-25WBPF-3SC HR41-25WBP-5SC

● Receptacle/Jack cap

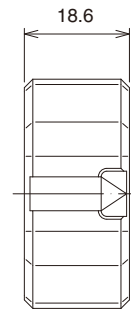
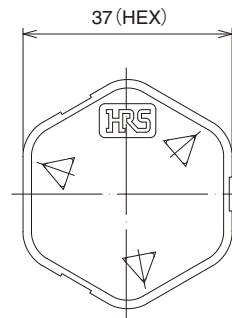

Part No.	HRS No.	Applicable Connectors
HR41-25WBR-C	141-0022-7	HR41-25WBR-3PC HR41-25WBRA-5PC HR41-25WBJB-3PC HR41-25WBJF-3PC

## ◆ Tools

Type	Part No.	HRS No.
Contact extraction tool	HR41-TP	150-0256-9



## ● Recommended Crimp Tools

### ◇ Manual Crimp Tools

Tool Maker	Part No.
HOZAN TOOL INDUSTRIAL CO.LTD	P-75
LOBTEX CO.,LTD.	AK15A
NICHIFU Co.,ltd	NH1



### ◇ Pneumatic Crimp Tools

Tool Maker	Part No.
Izumi Products Company	AC-5N.D Dies No.1 Head



Note : Please perform regular maintenance on your crimp tool according to its instruction manual. Doing so will ensure that it performs within the stated tolerances.

## ◆ Panel Mount Hole Dimensions

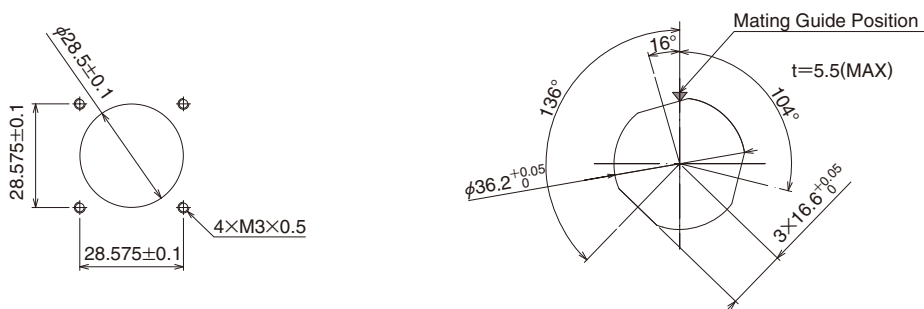

## ◆ Precautions for using connectors

1. Assembly and installation of connectors and components should be done in reference to the specified assembly procedures and with the proper amount of tightening torque.  
Care should be taken that loosening or damage could result when the torque is improperly applied. (Please contact your Hirose representative for the correct procedures.)
2. After mating a connector, pull on the cable slightly to confirm the connector is firmly in place.



**USA:**

**HIROSE ELECTRIC (U.S.A.), INC. HEADQUARTERS CHICAGO OFFICE**  
 2300 Warrenville Road, Suite 150,  
 Downers Grove, IL 60515  
 Phone : +1-630-282-6700  
<http://www.hirose.com/us/>

**USA:**

**HIROSE ELECTRIC (U.S.A.), INC. SAN JOSE OFFICE**  
 2841 Junction Ave, Suite 200  
 San Jose, CA. 95134  
 Phone : +1-408-253-9640  
 Fax : +1-408-253-9641  
<http://www.hirose.com/us/>

**USA:**

**HIROSE ELECTRIC (U.S.A.), INC. DETROIT OFFICE (AUTOMOTIVE)**  
 17197 N. Laurel Park Drive, Suite 253,  
 Livonia, MI 48152  
 Phone : +1-734-542-9963  
 Fax : +1-734-542-9964  
<http://www.hirose.com/us/>

**THE NETHERLANDS:**

**HIROSE ELECTRIC EUROPE B.V.**  
 Hogehillweg #8 1101 CC Amsterdam Z-O  
 Phone : +31-20-6557460  
 Fax : +31-20-6557469  
<http://www.hirose.com/eu/>

**GERMANY:**

**HIROSE ELECTRIC EUROPE B.V. GERMAN BRANCH**  
 Schoenbergstr. 20, 73760 ostfildern  
 Phone : +49-711-456002-1  
 Fax : +49-711-456002-299  
<http://www.hirose.com/eu/>

**GERMANY:**

**HIROSE ELECTRIC EUROPE B.V. NUREMBERG OFFICE**  
 Neumeyerstrasse 22-26, 90411 Nurnberg  
 Phone : +49-911 32 68 89 63  
 Fax : +49-911 32 68 89 69  
<http://www.hirose.com/eu/>

**GERMANY:**

**HIROSE ELECTRIC EUROPE B.V. HANOVER OFFICE**  
 Bayernstr. 3, Haus C 30855 Langenhagen, Germany  
 Phone : +49-511 97 82 61 30  
 Fax : +49-511 97 82 61 35  
<http://www.hirose.com/eu/>

**FRANCE:**

**HIROSE ELECTRIC EUROPE B.V. PARIS OFFICE**  
 Regus La Garenne Colombes, Place de La Belgique,  
 71 Boulevard National La Garenne Colombes, 92250, France  
 Phone : +33 (0) 1 7082 3170  
 Fax : +33 (1) 7082 3101  
<http://www.hirose.com/eu/>

**UNITED KINGDOM:**

**HIROSE ELECTRIC EUROPE BV (UK BRANCH)**  
 4 Newton Court, Kelvin Drive, Knowlhill,  
 Milton Keynes, MK5 8NH  
 Phone : +44-1908 202050  
 Fax : +44-1908 202058  
<http://www.hirose.com/eu/>

**CHINA:**

**HIROSE ELECTRIC (SHANGHAI) CO., LTD.**  
 1601, Henderson Metropolitan, NO.300, East Nanjing  
 Road, Huangpu District, Shanghai, China 200001  
 Phone : +86-21-6391-3355  
 Fax : +86-21-6391-3335  
<http://www.hirose.com/cn/>

**CHINA:**

**HIROSE ELECTRIC (SHANGHAI) CO.,LTD. BEIJING BRANCH**  
 A1001, Ocean International Center, Building 56# East 4th  
 Ring Middle Road, ChaoYang District, Beijing, 100025  
 Phone : +86-10-5165-9332  
 Fax : +86-10-5908-1381  
<http://www.hirose.com/cn/>

**CHINA:**

**HIROSE ELECTRIC TECHNOLOGIES (SHENZHEN) CO., LTD.**  
 Room 09-13, 19/F, Office Tower Shun-Hing Square, Di Wang Commercial Centre,  
 5002 Shen Nan Dong Road, Shenzhen City, Guangdong Province, 518008  
 Phone : +86-755-8207-0851  
 Fax : +86-755-8207-0873  
<http://www.hirose.com/cn/>

**HONG KONG:**

**HIROSE ELECTRIC HONGKONG TRADING CO., LTD.**  
 Room 1001, West Wing, Tsim Sha Tsui Centre, 66  
 Mody Road, Tsim Sha Tsui East, Kowloon, Hong Kong  
 Phone : +852-2803-5338  
 Fax : +852-2591-6560  
<http://www.hirose.com/hk/>

**TAIWAN:**

**HIROSE ELECTRIC TAIWAN CO., LTD.**  
 103 8F, No.87, Zhengzhou Rd., Taipei  
 Phone : +886-2-2555-7377  
 Fax : +886-2-2555-7350  
<http://www.hirose.com/tw/>

**KOREA:**

**HIROSE KOREA CO.,LTD.**  
 250, Huimanggongwon-ro, Siheung-si,  
 Gyeonggi-do, Korea, 15083  
 Phone : +82-31-496-7000 or 7124  
 Fax : +82-31-496-7100  
<http://www.hirose.co.kr/>

**SINGAPORE:**

**HIROSE ELECTRIC SINGAPORE PTE. LTD.**  
 10 Anson Road #26-16, International Plaza  
 079903, Singapore  
 Phone : +65-6324-6113  
 Fax : +65-6324-6123  
<http://www.hirose.com/sg/>

**INDIA:**

**HIROSE ELECTRIC SINGAPORE PTE. LTD. DELHI LIAISON OFFICE**  
 Office NO.552, Regus-Green Boulevard, Level5, Tower C,  
 Sec62, Plot B-9A, Block B, Noida, 201301, Uttar Pradesh, India  
 Phone : +91-12-660-8018  
 Fax : +91-120-4804949  
<http://www.hirose.com/sg/>

**INDIA:**

**HIROSE ELECTRIC SINGAPORE PTE. LTD. BANGALORE LIAISON OFFICE**  
 Unit No-403, 4th Floor, No-84, Barton Centre, Mahatma  
 Gandhi (MG) Road, Bangalore 560 001, Karnataka, India  
 Phone : +91-80-4120 1907  
 Fax : +91-80-4120 9908  
<http://www.hirose.com/sg/>

**MALAYSIA:**

**PENANG REPRESENTATIVE OFFICE**  
 1-21-01, Suntech @ Penang Cybercity (1164), Lintang  
 Mayang Pasir 3,11950, Bayan Baru, Penang, Malaysia.  
 Phone : +604-619-2564  
 Fax : +604-619-2574  
<http://www.hirose.com/sg/>

**THAILAND:**

**BANGKOK OFFICE (REPRESENTATIVE OFFICE)**  
 Unit 4703, 47th FL., 1 Empire Tower, South Sathorn  
 Road, Yannawa, Sathorn, Bangkok 10120 Thailand  
 Phone : +66-2-686-1255  
 Fax : +66-2-686-3433  
<http://www.hirose.com/sg/>



**HIROSE ELECTRIC CO.,LTD.**

2-6-3,Nakagawa Chuoh,Tsuzuki-Ku,Yokohama-Shi 224-8540,JAPAN  
 TEL: +81-45-620-3526 Fax: +81-45-591-3726  
<http://www.hirose.com>  
<http://www.hirose-connectors.com>

# Mouser Electronics

Authorized Distributor

Click to View Pricing, Inventory, Delivery & Lifecycle Information:

[Hirose Electric:](#)

[HR41-SC-161\(01\)](#) [HR41-25WBPA-3SC](#) [HR41-TP](#) [HR41-25WBP-3SC](#) [HT113/AC-5ND](#) [HT110/214A](#) [HR41-25WBJ-5PC](#)