

Multilayer Power Inductors

Type: **ELGTEA**

 This series is not a recommended product.
Not recommended for new design.

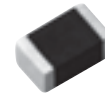

Features

- Superior DC current bias characteristics by the original laminating process technology
- Magnetic shielded structure
- Small and thin structure (2.0×1.25×1.0mm max.)
- RoHS compliant

Recommended Applications

- DC/DC converter circuit use of the small portable device
Smart phone, mobile phone, DSC .

Standard Packing Quantity

- 4000 pcs./Reel

Explanation of Part Numbers

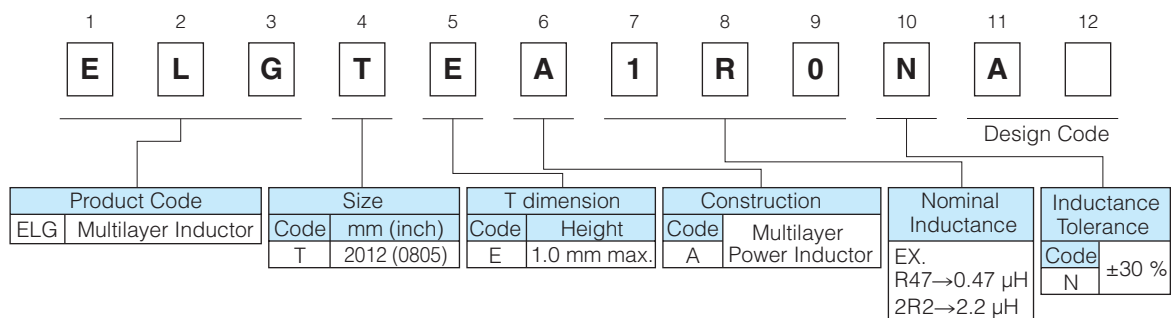

Dimensions in mm (not to scale)

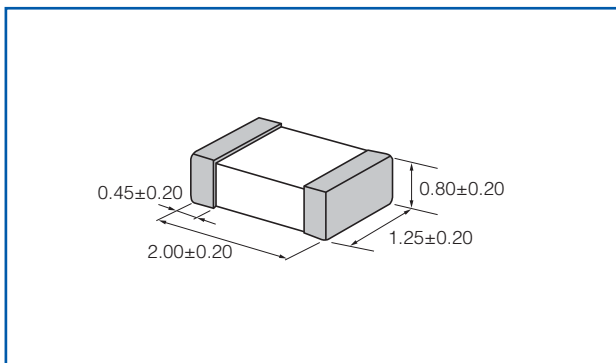

Recommended Land Pattern in mm (not to scale)

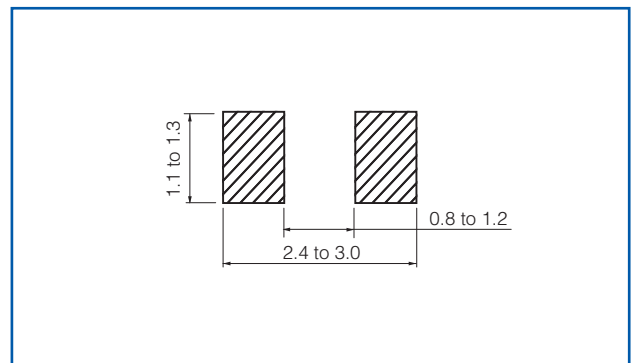

Ratings and Characteristics

Part Number	Inductance at 1 MHz		DC Resistance at 20 °C (Ω) max.	Rated Current* ¹ (A)	Self-resonant Frequency* ² (MHz)
	(μ H)	Tol.			
ELGTEAR47NA	0.47	$\pm 30\%$	0.10	1.2	126
ELGTEA1R0NA	1.0	$\pm 30\%$	0.15	1.0	80
ELGTEA1R5NA	1.5	$\pm 30\%$	0.18	1.0	80
ELGTEA2R2NA	2.2	$\pm 30\%$	0.20	0.8	55
ELGTEA3R3NA	3.3	$\pm 30\%$	0.25	0.8	50
ELGTEA4R7NA	4.7	$\pm 30\%$	0.30	0.8	33

● Operating Temperature Range : -40 to 125 °C (Including self-temperature rise)

*¹ This indicates the value of current when temperature rise $dt/t=40$ °C (at 20 °C).

*² Reference data

Inductance frequency characteristics

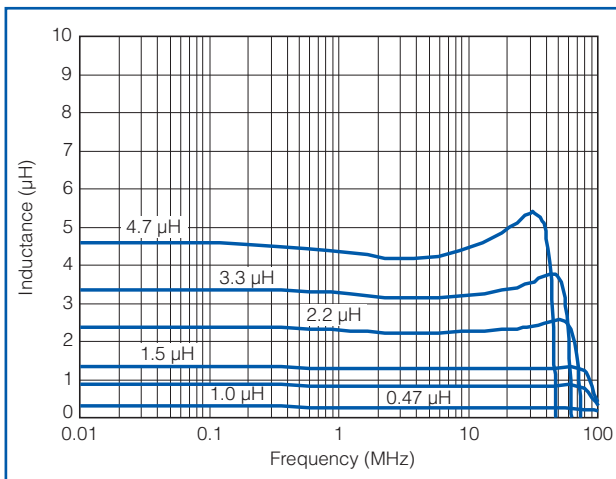

DC current bias characteristics

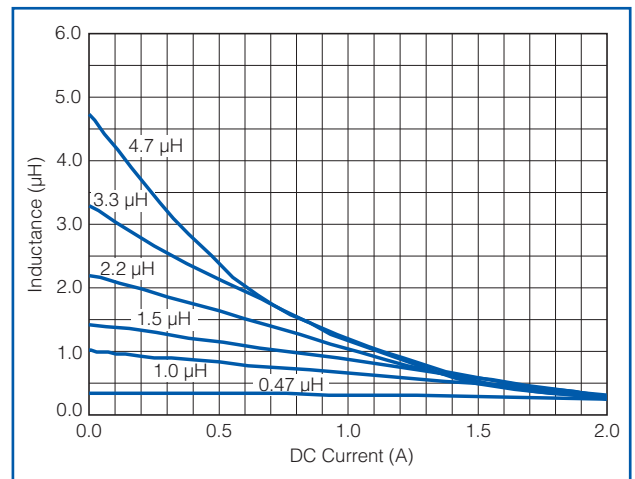

Packaging Methods (Taping)

● Punched Carrier Taping (Pitch 4mm)

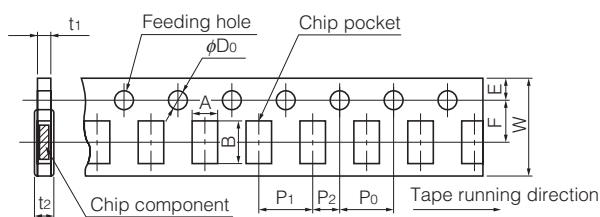

(Unit : mm)

Symbol	A	B	W	F	E	P ₁	P ₂	P ₀	ϕD_0	t ₁	t ₂
Dim (mm)	1.65 ± 0.20	2.4 ± 0.2	8.0 ± 0.2	3.50 ± 0.05	1.75 ± 0.10	4.0 ± 0.1	2.00 ± 0.05	4.0 ± 0.1	1.5 $+0.1$ 0	1.2 max.	1.4 max.

● Taping Reel

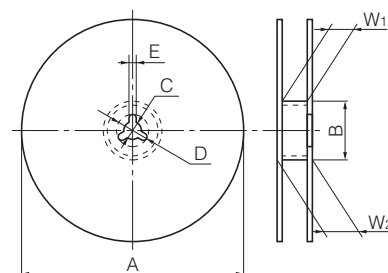

(Unit : mm)

Symbol	ϕA	ϕB	C	D	E	W ₁	W ₂
Dim (mm)	180 ₋₃ ⁰	60.0 ₀ ^{+1.0}	13.0 ± 0.5	21.0 ± 0.8	2.0 ± 0.5	9.0 ₀ ^{+1.0}	11.4 ± 1.0

● Leader Part and Taped End

Leader part

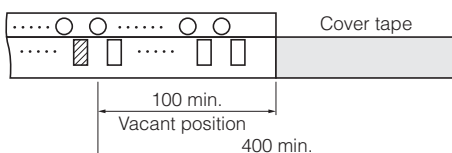

Tape end

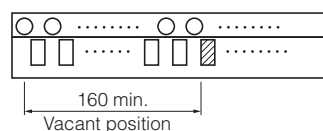

(Unit : mm)

Guidelines and precautions regarding the technical information and use of our products described in this online catalog.

- If you want to use our products described in this online catalog for applications requiring special qualities or reliability, or for applications where the failure or malfunction of the products may directly jeopardize human life or potentially cause personal injury (e.g. aircraft and aerospace equipment, traffic and transportation equipment, combustion equipment, medical equipment, accident prevention, anti-crime equipment, and/or safety equipment), it is necessary to verify whether the specifications of our products fit to such applications. Please ensure that you will ask and check with our inquiry desk as to whether the specifications of our products fit to such applications use before you use our products.
- The quality and performance of our products as described in this online catalog only apply to our products when used in isolation. Therefore, please ensure you evaluate and verify our products under the specific circumstances in which our products are assembled in your own products and in which our products will actually be used.
- If you use our products in equipment that requires a high degree of reliability, regardless of the application, it is recommended that you set up protection circuits and redundancy circuits in order to ensure safety of your equipment.
- The products and product specifications described in this online catalog are subject to change for improvement without prior notice. Therefore, please be sure to request and confirm the latest product specifications which explain the specifications of our products in detail, before you finalize the design of your applications, purchase, or use our products.
- The technical information in this online catalog provides examples of our products' typical operations and application circuits. We do not guarantee the non-infringement of third party's intellectual property rights and we do not grant any license, right, or interest in our intellectual property.
- If any of our products, product specifications and/or technical information in this online catalog is to be exported or provided to non-residents, the laws and regulations of the exporting country, especially with regard to security and export control, shall be observed.

<Regarding the Certificate of Compliance with the EU RoHS Directive/REACH Regulations>

- The switchover date for compliance with the RoHS Directive/REACH Regulations varies depending on the part number or series of our products.
- When you use the inventory of our products for which it is unclear whether those products are compliant with the RoHS Directive/REACH Regulation, please select "Sales Inquiry" in the website inquiry form and contact us.

We do not take any responsibility for the use of our products outside the scope of the specifications, descriptions, guidelines and precautions described in this online catalog.

Multilayer Power Inductors

Not recommended for new design

Type: **ELGTEA, ELGUEB**

Handling Precautions

⚠ Safety Precautions

Multilayer Power Inductors (hereafter referred to as “Inductors”) should be used for general purpose applications in consumer electronics (audio/visual, home, office, information & communication) equipment. When subjected to severe electrical, environmental, and/or mechanical stress beyond the specifications, as noted in the Ratings and Specified Conditions section, the Inductors may fail in a short circuit mode or in an open-circuit mode. This case results in a burn-out, smoke or flaming.

For products which require high safety levels, please carefully consider how a single malfunction can affect your product. In order to ensure the safety in the case of a single malfunction, please design products with fail-safe, such as setting up protecting circuits, etc.

- For the following applications and conditions, please contact us for additional specifications not found in this document.
 - When your application may have difficulty complying with the safety or handling precautions specified below.
 - For any applications where a malfunction with this product may directly or indirectly cause hazardous conditions which could result in death or injury;
 - ① Aircraft and Aerospace Equipment (artificial satellite, rocket, etc.)
 - ② Submarine Equipment (submarine repeating equipment, etc.)
 - ③ Transport Equipment (motor vehicles, airplanes, trains, ship, traffic signal controllers, etc.)
 - ④ Power Generation Control Equipment (atomic power, hydroelectric power, thermal power plant control system, etc.)
 - ⑤ Medical Equipment (life-support equipment, pacemakers, dialysis controllers, etc.)
 - ⑥ Information Processing Equipment (large scale computer system, etc.)
 - ⑦ Electric Heating Appliances, Combustion devices (gas fan heaters, oil fan heaters, etc.)
 - ⑧ Rotary Motion Equipment
 - ⑨ Security Systems
 - ⑩ And any similar types of equipment

⚠ Strict Observance

1. Confirmation of Rated Performance

The Inductors shall be operated within the specified rating/performance.

Application exceeding the specifications may cause deteriorated performance and/or breakdown, resulting in degradation and/or smoking or ignition of products. The following are strictly observed.

- (1) The Inductors should be use within the specified operating temperature range including self-fever.
- (2) The electricity electric current of the inductor should be use in less than rated current.

2. The Inductors shall not be mounted near inflammables.

3. The inductors shall not be bring a magnet and the thing which became magnetized close.

■ Operating Conditions and Circuit Design

1. Circuit Design

1.1 Operating Temperature and Storage Temperature

The specified “Operating Temperature Range” found in the Specification is the absolute maximum and minimum temperature rating. Every Inductor shall be operated within the specified “Operating Temperature Range”.

The Inductors mounted on PWB shall be stored without operating within the specified “Storage Temperature Range” in the Specifications.

1.2 Operating Current

The Inductors shall not be operated in excess of the “Rated current”. If the Inductors are operated beyond the specified “Rated current”, it may cause

short and/or damage due to thermal run away. When high frequency and steep pulse current are continuously used, even when less than the “Rated current”, in a circuit, please examine the reliability of the Inductor while also checking the safety and reliability of your circuit. Check safety and reliability in your circuit.

1.3 Self-heating

The surface temperature of the Inductors shall be under the specified Maximum Operating Temperature in the Specifications including the temperature rise cause by self-heating. Check temperature rise of the Inductor in your circuit.

1.4 Environmental Restrictions

The Inductors shall not be operated and/or stored under the following conditions.

- (1) Environmental conditions
 - (a) Under direct exposure to water or salt water
 - (b) Under conditions where water can condense and/or dew can form
 - (c) Under conditions containing corrosive gases such as hydrogen sulfide, sulfurous acid, chlorine and ammonia
- (2) Mechanical conditions

Under severe conditions of vibration or impact beyond the specified conditions found in the Specifications.

2. Design of Printed Circuit Board

2.1 Selection of Printed Circuit Boards

When the Inductors are mounted and soldered on an "Alumina Substrate", the substrate influences the Inductors' reliability against "Temperature Cycles" and "Heat shock" due to the difference in the thermal expansion coefficient between them. Confirm that the actual board used does not deteriorate the characteristics of the Inductors.

2.2 Design of Land Pattern

- (1) Recommended land dimensions are shown below. Use the proper amount of solder in order to prevent cracking. Using too much solder places excessive stress on the Inductors.

Recommended Land Dimensions

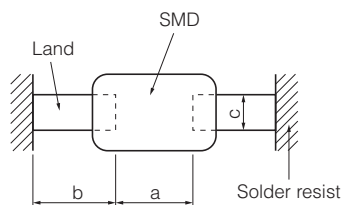

Unit (mm)

Size Code (inch)	Component dimensions			a	b	c
	L	W	T			
T(0805)	2.0	1.25	1.0 max.	0.8 to 1.2	0.6 to 1.1	1.1 to 1.3
U(0806)	2.0	1.60	1.0 max.	0.8 to 1.2	0.6 to 1.1	1.2 to 1.4

- (2) The size of lands shall be designed to have equal spacing between the right and left sides. If the amount of solder on the right land is different from that on the left land, the component may be cracked by stress since the side with a larger amount of solder solidifies later during cooling.

Recommended Amount of Solder

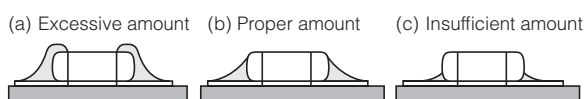

2.3 Utilization of Solder Resist

- (1) Solder resist shall be utilized to equalize the amounts of solder on both sides.
- (2) Solder resist shall be used to divide the pattern for the following cases;
 - Components are arranged closely.
 - The Inductor is mounted near a component with lead wires.
 - The Inductor is placed near a chassis.
 See the table below.

Prohibited Applications and Recommended Applications

Item	Prohibited applications	Improved applications by pattern division
Mixed mounting with a component with lead wires	The lead wire of a component with lead wires	Solder resist
Arrangement near chassis	Chassis Solder (Ground solder) Electrode pattern	Solder resist
Retro-fitting of component with lead wires	Soldering iron A lead wire of Retro-fitted component	Solder resist
Lateral arrangement	Portion to be excessively soldered Land	Solder resist

2.4 Component Layout

The Inductors/components shall be placed on the PC board such that both electrodes are subjected to uniform stresses, or to position the component electrodes at right angles to the grid glove or bending line. This should be done to avoid cracking the Inductors from bending the PC board after or during placing/mounting on the PC board.

- (1) To minimize mechanical stress caused by the warp or bending of a PC board, please follow the recommended Inductors' layout below.

Prohibited layout	Recommended layout
	 Layout the Inductor sideways against the stressing direction.

(2) The following layout is for your reference since mechanical stress near the dividing/breaking position of a PC board varies depending on the mounting position of the Inductors.

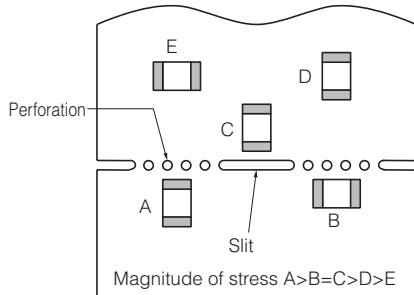

(3) The magnitude of mechanical stress applied to the Inductors when the circuit board is divided is in the order of push back < slit < V-groove < perforation.

Also take into account the layout of the Inductors and the dividing/breaking method.

2.5 Mounting Density and Spaces

If components are arranged in too narrow a space, the components can be affected by solder bridges and solder balls. The space between components should be carefully determined.

■ Precautions for Assembly

1. Storage

- (1) The Inductors shall be stored between 5 - 40 °C and 20 - 70 %RH, not under severe conditions of high temperature and humidity.
- (2) If stored in a place that is humid, dusty, or contains corrosive gasses (hydrogen sulfide, sulfurous acid, hydrogen chloride and ammonia etc.), the solderability of terminal electrodes may deteriorate.

In addition, storage in a place subjected to heating and/or exposure to direct sunlight will cause deformed tapes and reels, and component sticking to tapes, both of which can result in mounting problems.

- (3) Do not store components longer than 6 months. Check the solderability of products that have been stored for more than 6 months before use.

2. Adhesives for Mounting

- (1) The amount and viscosity of an adhesive for mounting shall be such that the adhesive shall not flow off on the land during its curing.
- (2) If the amount of adhesive is insufficient for mounting, the Inductors may fall off after or during soldering.
- (3) If the adhesive is too low in its viscosity, the Inductors may be out of alignment after or during soldering.

- (4) Adhesives for mounting can be cured by ultraviolet or infrared radiation. In order to prevent the terminal electrodes of the Inductors from oxidizing, the curing shall be done under the following conditions:
160 °C max., for 2 minutes max.

- (5) Insufficient curing may cause the Inductors to fall off after or during soldering. In addition, insulation resistance between terminal electrodes may deteriorate due to moisture absorption. In order to prevent these problems, please observe proper curing conditions.

3. Chip Mounting Consideration

- (1) When mounting the Inductors/components on a PC board, the Inductor bodies shall be free from excessive impact loads such as mechanical impact or stress due to the positioning, pushing force and displacement of vacuum nozzles during mounting.

- (2) Maintenance and inspection of the Chip Mounter must be performed regularly.

- (3) If the bottom dead center of the vacuum nozzle is too low, the Inductor will crack from excessive force during mounting.

The following precautions and recommendations are for your reference in use.

- (a) Set and adjust the bottom dead center of the vacuum nozzles to the upper surface of the PC board after correcting the warp of the PC board.
- (b) Set the pushing force of the vacuum nozzle during mounting to 1 to 3 N in static load.
- (c) For double surface mounting, apply a supporting pin on the rear surface of the PC board to suppress the bending of the PC board in order to minimize the impact of the vacuum nozzles. Typical examples are shown in the table below.

Item	Prohibited mounting	Recommended mounting
Single surface mounting		
Double surface mounting		

- (d) Adjust the vacuum nozzles so that their bottom dead center during mounting is not too low.

- (4) The closing dimensions of the positioning chucks shall be controlled. Maintenance and replacement of positioning chucks shall be performed regularly to prevent chipping or cracking of the Inductors caused by mechanical impact during positioning due to worn positioning chucks.

(5) Maximum stroke of the nozzle shall be adjusted so that the maximum bending of PC board does not exceed 0.5mm at 90 mm span. The PC board shall be supported by an adequate number of supporting pins.

4. Selection of Soldering Flux

Soldering flux may seriously affect the performance of the Inductors. Please confirm whether soldering flux does not have an influence on performance of the Inductor before using enough.

5. Soldering

5.1 Reflow Soldering

The reflow soldering temperature conditions are each temperature curves of Preheating, Temp. rise, Heating, Peak and Gradual cooling. Large temperature difference caused by rapid heat application to the Inductors may lead to excessive thermal stresses, contributing to the thermal cracks. The Preheating temperature requires controlling with great care so that tombstone phenomenon may be prevented.

Item	Temperature	Period or Speed
① Preheating	140 to 180 °C	60 to 120 sec
② Temp. rise	Preheating temp to Peak temp.	2 to 5 °C /sec
③ Heating	220 °C min.	60 sec max.
④ Peak	260 °C max.	10 sec max.
⑤ Gradual cooling	Peak temp. to 140 °C	1 to 4 °C /sec

Recommended profile of Reflow soldering (EX)

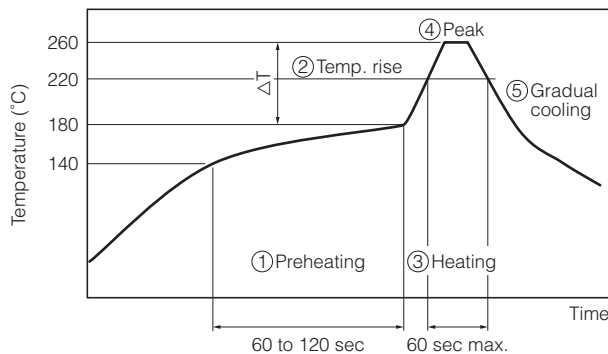

ΔT : Allowable temperature difference $\Delta T \leq 150 \text{ }^\circ\text{C}$

The rapid cooling (forced cooling) during Gradual cooling part should be avoided, because this may cause defects such as the thermal cracks, etc.

When the Inductors are immersed into a cleaning solvent, make sure that the surface temperatures of the devices do not exceed 100 °C.

Performing reflow soldering twice under the conditions shown in the figure above [Recommended profile of Reflow soldering (EX)] will not cause any problems. However, pay attention to the possible warp and bending of the PC board.

5.2 Hand Soldering

Hand soldering typically causes significant temperature change, which may induce excessive thermal stresses inside the Inductors, resulting in the thermal cracks, etc. In order to prevent any defects, the following should be observed;

- The temperature of the soldering tips should be controlled with special care.
- The direct contact of soldering tips with the Inductors and/or terminal electrodes should be avoided.
- Dismounted Inductors shall not be reused.

(1) Condition 1 (with preheating)

(a) Soldering :

$\phi 1.0$ mm Thread eutectic solder with soldering flux* in the core.

*Rosin-based and non-activated flux is Recommended.

(b) Preheating :

The Inductors shall be preheated so that the "Temperature Gradient" between the devices and the tip of soldering iron is 150 °C or below.

(c) Temperature of Iron tip: 350 °C max.

(The required amount of solder shall be melted in advance on the soldering tip.)

(d) Gradual cooling :

After soldering, the Inductors shall be cooled gradually at room temperature.

Recommended profile of Hand soldering [EX]

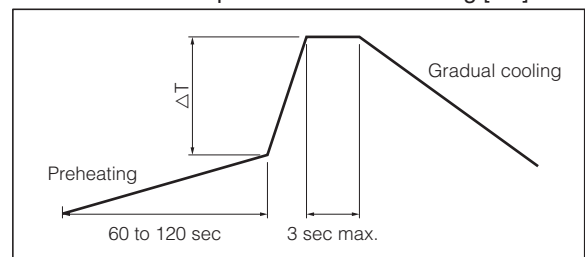

ΔT : Allowable temperature difference $\Delta T \leq 150 \text{ }^\circ\text{C}$

(2) Condition 2 (without preheating)

Hand soldering can be performed without preheating, by following the conditions below:

- (a) Soldering iron tip shall never directly touch the ceramic and terminal electrodes of the Inductors.
- (b) The lands are sufficiently preheated with a soldering iron tip before sliding the soldering iron tip to the terminal electrodes of the Inductors for soldering.

Conditions of Hand soldering without preheating

	Condition
Temperature of Iron tip	270 °C max.
Wattage	20 W max.
Shape of Iron tip	$\phi 3$ mm max.
Soldering time with a soldering iron	3 sec max.

6. Post Soldering Cleaning

6.1 Cleaning solvent

Soldering flux residue may remain on the PC board if cleaned with an inappropriate solvent. This may deteriorate the electrical characteristics and reliability of the Inductors.

6.2 Cleaning conditions

Inappropriate cleaning conditions such as insufficient cleaning or excessive cleaning may impair the electrical characteristics and reliability of the Inductors.

- (1) Insufficient cleaning can lead to :
 - (a) The halogen substance found in the residue of the soldering flux may cause the metal of terminal electrodes to corrode.
 - (b) The halogen substance found in the residue of the soldering flux on the surface of the Inductors may change resistance values.
 - (c) Water-soluble soldering flux may have more remarkable tendencies of (a) and (b) above compared to those of rosin soldering flux.
- (2) Excessive cleaning can lead to :
 - (a) Overuse of ultrasonic cleaning may deteriorate the strength of the terminal electrodes or cause cracking in the solder and/or ceramic bodies of the Inductors due to vibration of the PC boards.

Please follow these conditions for Ultrasonic cleaning :

- Ultrasonic wave output : 20 W/L max.
- Ultrasonic wave frequency : 40 kHz max.
- Ultrasonic wave cleaning time : 5 min. max.

6.3 Contamination of Cleaning solvent

Cleaning with contaminated cleaning solvent may cause the same results as insufficient cleaning due to the high density of liberated halogen.

7. Inspection Process

When mounted PC boards are inspected with measuring terminal pins, abnormal and excess mechanical stress shall not be applied to the PC board or mounted components, to prevent failure or damage to the devices.

- (1) Mounted PC boards shall be supported by an adequate number of supporting pins with bend settings of 90 mm span 0.5 mm max.
- (2) Confirm that the measuring pins have the right tip shape, are equal in height and are set in the correct positions.

The following figures are for your reference to avoid bending the PC board.

	Prohibited setting	Recommended setting
Bending of PC board		

8. Protective Coating

When the surface of a PC board on which the Inductors have been mounted is coated with resin to protect against moisture and dust, it shall be confirmed that the protective coating which is corrosive or chemically active is not used, in order that the reliability of the Inductors in the actual equipment may not be influenced. Coating materials that expand or shrink also may lead to damage to the Inductor during the curing process.

9. Dividing/Breaking of PC Boards

- (1) Abnormal and excessive mechanical stress such as bending or torsion shown below can cause cracking in the Inductors.

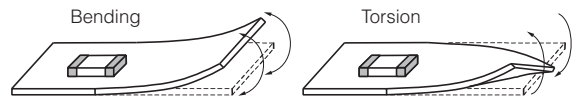

- (2) Dividing/Breaking of the PC boards shall be done carefully at moderate speed by using a jig or apparatus to prevent the Inductors on the boards from mechanical damage.

- (3) Examples of PWB dividing/breaking jigs :
The outline of PC board breaking jig is shown below.

When PC board are broken or divided, loading points should be close to the jig to minimize the extent of the bending.

Also, planes with no parts mounted on should be used as plane of loading, which generates a compressive stress on the mounted plane, in order to prevent tensile stress induced by the bending, which may cause cracks of the Inductors or other parts mounted on the PC boards.

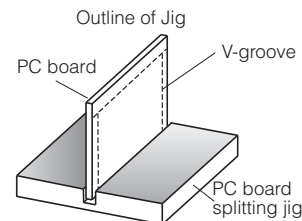

Prohibited dividing	Recommended dividing

10. Mechanical Impact

- (1) The Inductors shall be free from any excessive mechanical impact. The Inductor body is made of ceramics and may be damaged or cracked if dropped. Never use an Inductor which has been dropped; their quality may be impaired and failure rate increased.
- (2) When handling PC boards with Inductors mounted on them, do not allow the Inductors to collide with another PC board. When mounted PC boards are handled or stored in a stacked state, impact between the corner of a PC board and the Inductor may cause damage or cracking and can deteriorate the withstand voltage and insulation resistance of the Inductor.

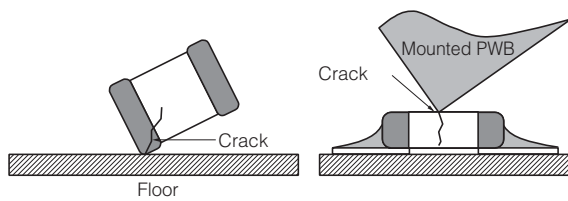

■ Other

The various precautions described above are typical. For special mounting conditions, please contact us.