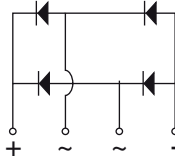


## Enhanced isoCink+™ Bridge Rectifiers



isoCink+™  
Case Style BU



### FEATURES

- UL recognition file number E312394
- Thin single in-line package
- Glass passivated chip junction
- Available for BU-5S lead forming option (part number with "5S" suffix, e.g. BU15065S)
- Superior thermal conductivity
- Solder dip 275 °C max. 10 s, per JESD 22-B106
- Material categorization: for definitions of compliance please see [www.vishay.com/doc?99912](http://www.vishay.com/doc?99912)



**RoHS**  
COMPLIANT  
HALOGEN  
**FREE**  
Available

### TYPICAL APPLICATIONS

General purpose use in AC/DC bridge full wave rectification for switching power supply, home appliances and white-goods applications.

### MECHANICAL DATA

#### Case: BU

Molding compound meets UL 94 V-0 flammability rating  
Base P/N-E3 - RoHS-compliant, commercial grade  
Base P/N-M3 - halogen-free, RoHS-compliant, and commercial grade

**Terminals:** matte tin plated leads, solderable per J-STD-002 and JESD 22-B102  
E3 and M3 suffix meet JESD 201 class 1A whisker test

**Polarity:** as marked on body

**Mounting Torque:** 10 cm-kg (8.8 inches-lbs) max.

**Recommended Torque:** 5.7 cm-kg (5 inches-lbs)

PRIMARY CHARACTERISTICS	
Package	BU
$I_{F(AV)}$	15 A
$V_{RRM}$	600 V, 800 V, 1000 V
$I_{FSM}$	200 A
$I_R$	5 $\mu$ A
$V_F$ at $I_F = 7.5$ A	0.87 V
$T_J$ max.	150 °C
Circuit configuration	In-line

MAXIMUM RATINGS ( $T_A = 25$ °C unless otherwise noted)					
PARAMETER	SYMBOL	BU1506	BU1508	BU1510	UNIT
Maximum repetitive peak reverse voltage	$V_{RRM}$	600	800	1000	V
Average rectified forward current (Fig. 1, 2)	$I_O$	$T_C = 80$ °C (1)		15	A
		$T_A = 25$ °C (2)		3.4	
Non-repetitive peak forward surge current 8.3 ms single sine-wave, $T_J = 25$ °C	$I_{FSM}$	200			A
Rating for fusing ( $t < 8.3$ ms) $T_J = 25$ °C	$I^2t$	160			A <sup>2</sup> s
Operating junction and storage temperature range	$T_J, T_{STG}$	-55 to +150			°C

#### Notes

- (1) With 60 W air cooled heatsink  
(2) Without heatsink, free air

ELECTRICAL CHARACTERISTICS ( $T_A = 25$ °C unless otherwise noted)						
PARAMETER	TEST CONDITIONS	SYMBOL	TYP.	MAX.	UNIT	
Maximum instantaneous forward voltage per diode (1)	$I_F = 7.5$ A	$T_A = 25$ °C	$V_F$	0.97	1.05	V
		$T_A = 125$ °C		0.87		
Maximum reverse current per diode	rated $V_R$	$T_A = 25$ °C	$I_R$	-	5.0	$\mu$ A
		$T_A = 125$ °C		90		
Typical junction capacitance per diode	4.0 V, 1 MHz	$C_J$	70	-	pF	

#### Note

- (1) Pulse test: 300  $\mu$ s pulse width, 1 % duty cycle

<b>THERMAL CHARACTERISTICS</b> ( $T_A = 25\text{ }^\circ\text{C}$ unless otherwise noted)					
PARAMETER	SYMBOL	BU1506	BU1508	BU1510	UNIT
Typical thermal resistance	$R_{\theta JC}$ <sup>(1)</sup>	2.5			$^\circ\text{C}/\text{W}$
	$R_{\theta JA}$ <sup>(2)</sup>	20			

**Notes**

- (1) With 60 W air cooled heatsink  
 (2) Without heatsink, free air

<b>ORDERING INFORMATION</b> (Example)				
PREFERRED P/N	UNIT WEIGHT (g)	PREFERRED PACKAGE CODE	BASE QUANTITY	DELIVERY MODE
BU1506-E3/45	4.75	45	20	Tube
BU1506-E3/51	4.75	51	250	Paper tray
BU1506-M3/45	4.75	45	20	Tube
BU1506S-E3/45	4.75	45	20	Tube

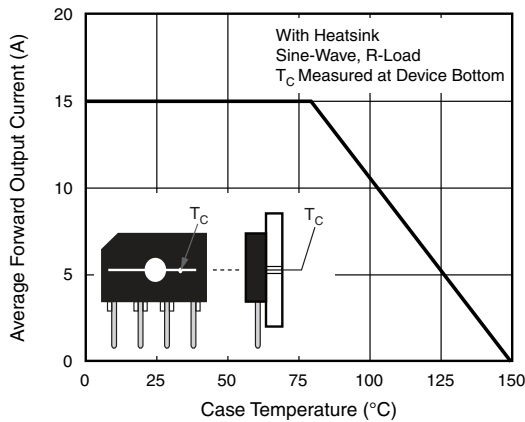
**RATINGS AND CHARACTERISTICS CURVES** ( $T_A = 25\text{ }^\circ\text{C}$  unless otherwise specified)


Fig. 1 - Derating Curve Output Rectified Current

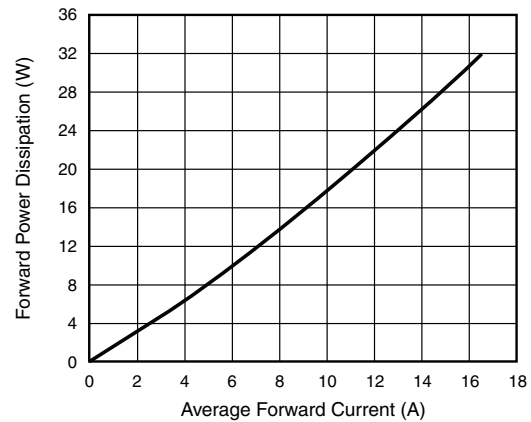


Fig. 3 - Forward Power Dissipation

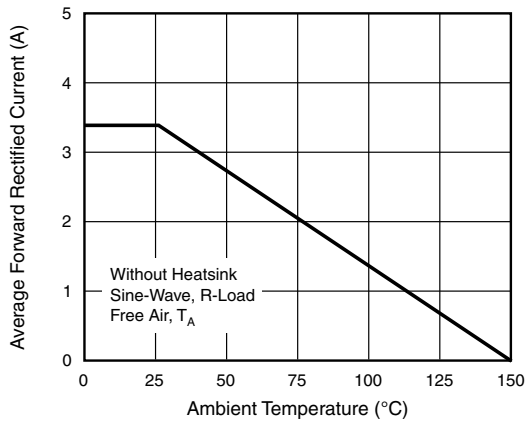


Fig. 2 - Forward Current Derating Curve

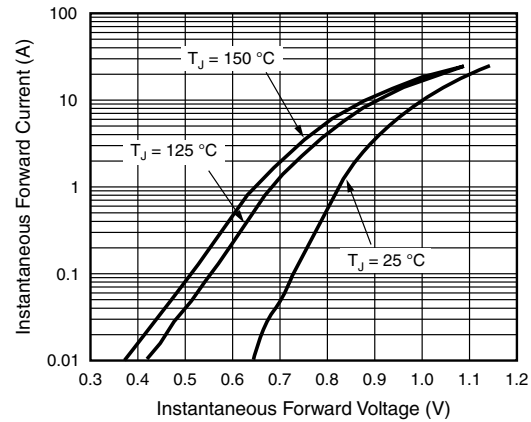


Fig. 4 - Typical Forward Characteristics Per Diode

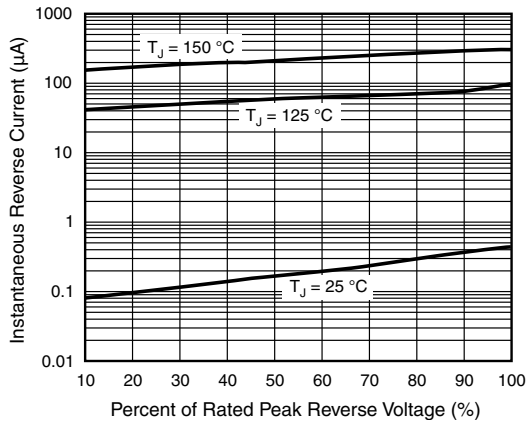


Fig. 5 - Typical Reverse Characteristics Per Diode

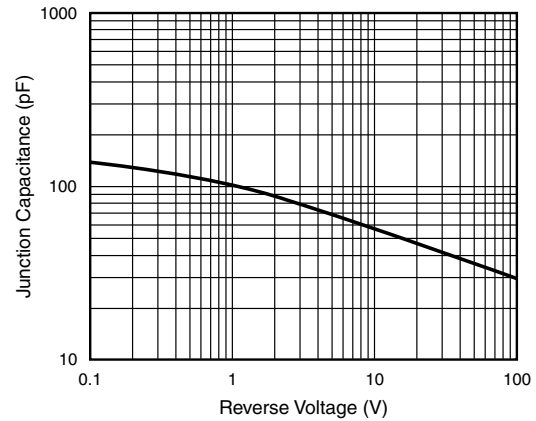
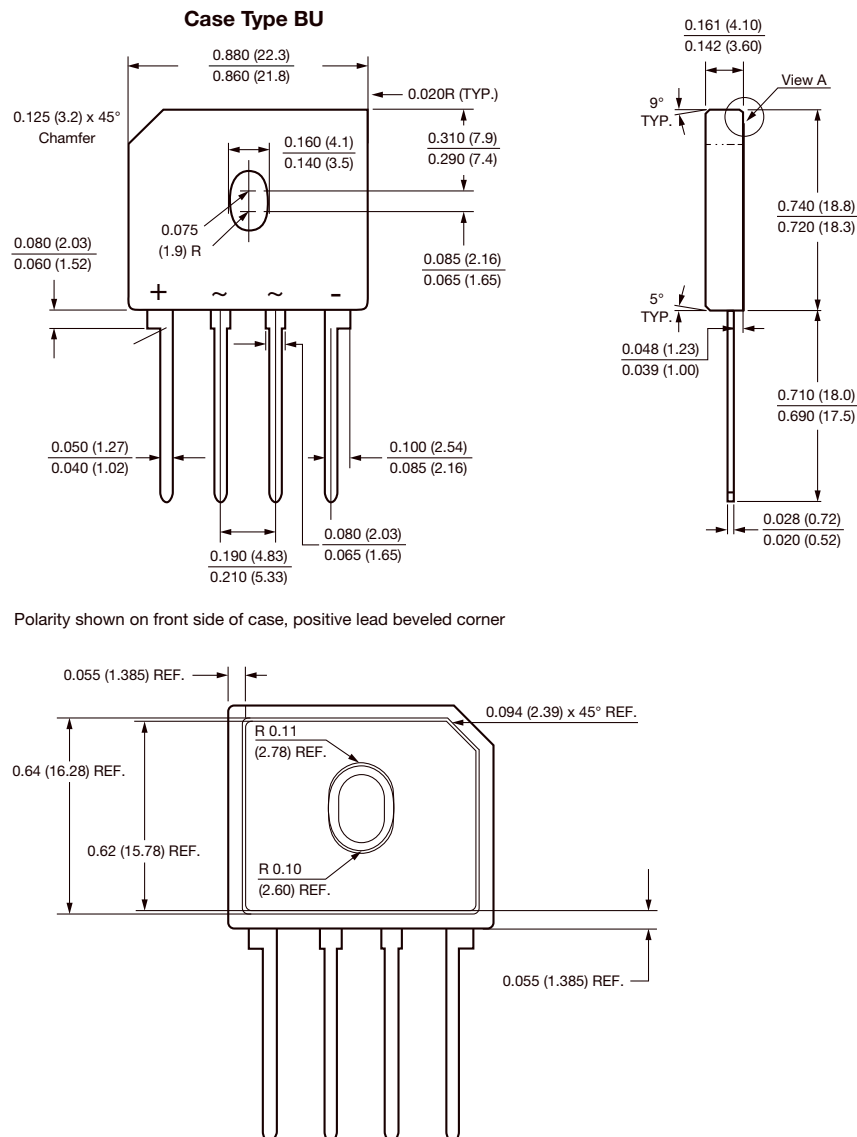


Fig. 6 - Typical Junction Capacitance Per Diode

**PACKAGE OUTLINE DIMENSIONS** in inches (millimeters)







## **Disclaimer**

ALL PRODUCT, PRODUCT SPECIFICATIONS AND DATA ARE SUBJECT TO CHANGE WITHOUT NOTICE TO IMPROVE RELIABILITY, FUNCTION OR DESIGN OR OTHERWISE.

Vishay Intertechnology, Inc., its affiliates, agents, and employees, and all persons acting on its or their behalf (collectively, "Vishay"), disclaim any and all liability for any errors, inaccuracies or incompleteness contained in any datasheet or in any other disclosure relating to any product.

Vishay makes no warranty, representation or guarantee regarding the suitability of the products for any particular purpose or the continuing production of any product. To the maximum extent permitted by applicable law, Vishay disclaims (i) any and all liability arising out of the application or use of any product, (ii) any and all liability, including without limitation special, consequential or incidental damages, and (iii) any and all implied warranties, including warranties of fitness for particular purpose, non-infringement and merchantability.

Statements regarding the suitability of products for certain types of applications are based on Vishay's knowledge of typical requirements that are often placed on Vishay products in generic applications. Such statements are not binding statements about the suitability of products for a particular application. It is the customer's responsibility to validate that a particular product with the properties described in the product specification is suitable for use in a particular application. Parameters provided in datasheets and / or specifications may vary in different applications and performance may vary over time. All operating parameters, including typical parameters, must be validated for each customer application by the customer's technical experts. Product specifications do not expand or otherwise modify Vishay's terms and conditions of purchase, including but not limited to the warranty expressed therein.

Except as expressly indicated in writing, Vishay products are not designed for use in medical, life-saving, or life-sustaining applications or for any other application in which the failure of the Vishay product could result in personal injury or death. Customers using or selling Vishay products not expressly indicated for use in such applications do so at their own risk. Please contact authorized Vishay personnel to obtain written terms and conditions regarding products designed for such applications.

No license, express or implied, by estoppel or otherwise, to any intellectual property rights is granted by this document or by any conduct of Vishay. Product names and markings noted herein may be trademarks of their respective owners.

# Mouser Electronics

Authorized Distributor

Click to View Pricing, Inventory, Delivery & Lifecycle Information:

[Vishay:](#)

[BU1506-E3/45](#) [BU1506-E3/51](#) [BU1508-E3/45](#) [BU1508-E3/51](#) [BU15105S-E3/45](#) [BU1510-E3/45](#) [BU15065S-E3/45](#)  
[BU1510-E3/51](#) [BU15085S-E3/45](#)