

## Automotive dual-line TVS in SOT23-3L for CAN bus

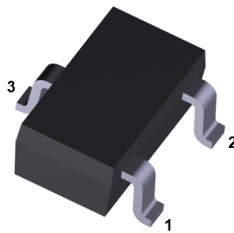

**SOT23-3L**  
(Jedec TO-236)

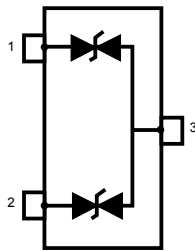

## Product status link

ESDCANxx-2BLY	<a href="#">ESDCAN01-2BLY</a> , <a href="#">ESDCAN24-2BLY</a> , <a href="#">ESDCAN04-2BLY</a> , <a href="#">ESDCAN06-2BLY</a>
---------------	--

## Features

- AEC-Q101 qualified 
- Dual-line ESD and EOS protection
- Breakdown voltage:  $V_{BR}$ 
  - ESDCAN01-2BLY: 25 V
  - ESDCAN24-2BLY: 27 V
  - ESDCAN04-2BLY: 27.5 V
  - ESDCAN06-2BLY: 38 V
- Bidirectional device
- Max pulse power up to 230 W (8/20  $\mu$ s)
- Low clamping factor  $V_{CL} / V_{BR}$
- Low leakage current
- **ECOPACK** ROHS compliant component

## Complies with the following standards

- UL94, V0
- J-STD-020 MSL level 1
- IPC7531 footprint and JEDEC registered package
- ISO 16750-2 (Jump start and reversed battery tests)
- ISO 10605 - C = 150 pF, R = 330  $\Omega$ , exceeds level 4:
  - $\pm 30$  kV (air discharge)
  - $\pm 30$  kV (contact discharge)
- ISO 10605 - C = 330 pF, R = 330  $\Omega$  exceeds level 4:
  - $\pm 30$  kV (air discharge)
  - $\pm 30$  kV (contact discharge)
- ISO 7637-3:
  - Pulse 3a: -150 V
  - Pulse 3b: +150 V
  - Pulse 2a: +/- 85 V

## Applications

Automotive controller area network (CAN) bus lines where electrostatic discharges and other transients must be suppressed. This product is compliant with most of automotive interfaces.

## Description

The ESDCAN0xx-2BLY are dual-line TVS specifically designed for the protection of automotive CAN bus lines against electrostatic discharge (ESD).

Its improved parameters make it compliant with all key interfaces in automotive: CAN-FD, LIN, FlexRay, MOST, SENT, USB, etc.

# 1 Characteristics

**Table 1. Absolute ratings ( $T_{amb} = 25\text{ }^{\circ}\text{C}$ )**

Symbol	Parameter		Value	Unit	
$V_{PP}$	Peak pulse voltage	ISO 10605 - C = 150 pF, R = 330 $\Omega$ : Contact discharge	30	kV	
		Air discharge	30		
		ISO 10605 - C = 330 pF, R = 330 $\Omega$ : Contact discharge	ESDCAN24-2BLY ESDCAN01-2BLY		30
		Air discharge	ESDCAN04-2BLY		30
		ISO 10605 - C = 330 pF, R = 330 $\Omega$ : Contact discharge	ESDCAN06-2BLY		22
		Air discharge			22
$I_{PP}$	Peak pulse current (8/20 $\mu\text{s}$ )	ESDCAN24-2BLY ESDCAN01-2BLY	5.5	A	
		ESDCAN04-2BLY	3.7		
		ESDCAN06-2BLY	3		
$T_j$	Operating junction temperature range		-40 to +150	$^{\circ}\text{C}$	
$T_{stg}$	Storage temperature range		-55 to +150	$^{\circ}\text{C}$	

**Figure 1. Electrical characteristics (definitions)**

Symbol	Parameter
$V_{BR}$ =	Breakdown voltage
$V_{RM}$ =	stand-off voltage
$V_{CL}$ =	Clamping voltage
$I_{RM}$ =	Leakage current at $V_{RM}$
$I_{PP}$ =	Peak pulse current
$R_d$ =	Dynamic impedance
$C_{LINE}$ =	Input capacitance per line

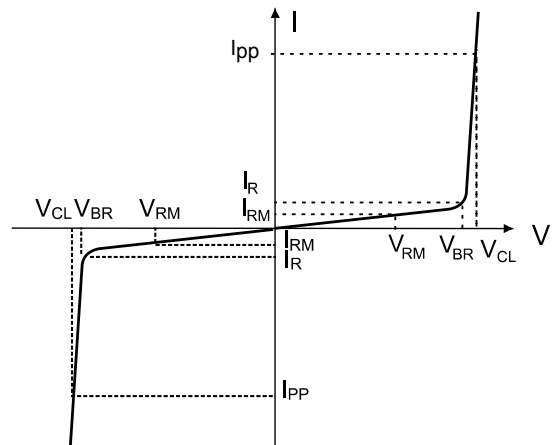

**Table 2. Electrical characteristics (values,  $T_{amb} = 25\text{ °C}$ )**

Order code	$I_{RM}$ max. at $V_{RM}$		$V_{BR}$ at $I_R$			$V_{CL}$ Pulse ISO7637-3		$V_{CL}$ at $I_{PP}$ (8/20 $\mu$ s)		C		$\Delta C^{(1)}$	$\alpha T^{(2)}$
			Min.	Max.		3a at -150 V min.	3b at +150 V max.	Max.		Typ.	Max.	Typ.	Typ.
	$\mu$ A	V	V		mA	V		V	A	pF		pF	$10^{-4}/\text{°C}$
ESDCAN24-2BLY	0.1	24	27	32	1	-40	40	43	5	-	30	0.1	9
ESDCAN01-2BLY	0.1	24	25	30	1	-35	35	40	5	-	30	0.1	9
ESDCAN04-2BLY	0.05	25.5	27.5	30.7	1	-35	35	43	3	17	19	0.1	9
ESDCAN06-2BLY	0.1	35	38	42.2	1	-44	44	59	3	13	15	0.1	9

1.  $\Delta C$  : capacitance variation between IO1 and IO2 versus GND

2. to calculate  $V_{BR}$  versus  $T_j$ ;  $V_{BR}$  at  $T_j = V_{BR}$  at  $25\text{ °C} \times (1 + \alpha T \times (T_j - 25))$

### 1.1 Characteristics (curves)

Figure 2. Maximum peak current versus initial junction temperature

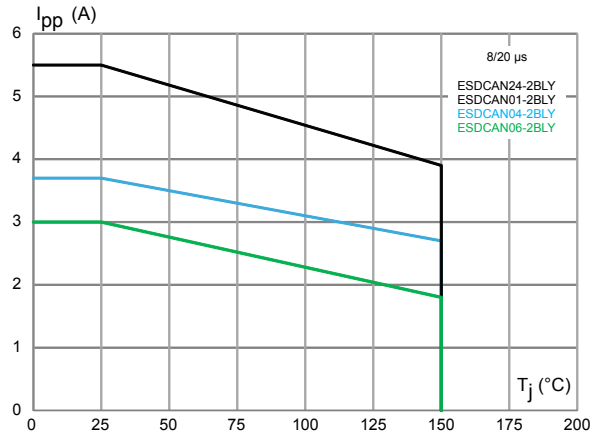

Figure 3. Maximum peak pulse current versus exponential pulse duration

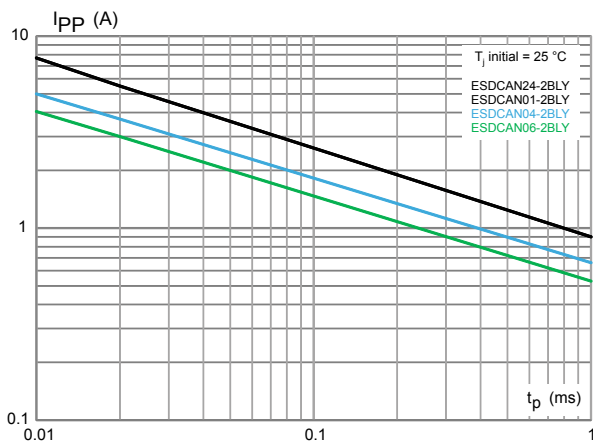
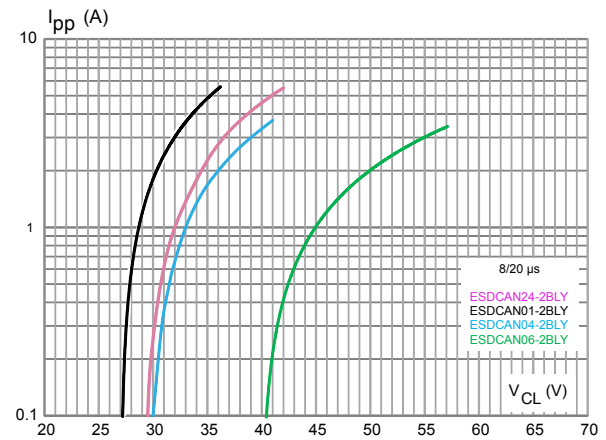
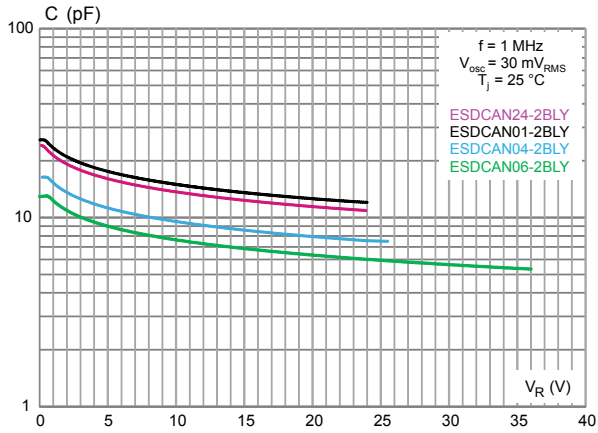

Figure 4. Clamping voltage versus peak pulse current



**Figure 5. Junction capacitance versus reverse voltage**



**Figure 6. Leakage current versus junction temperature**

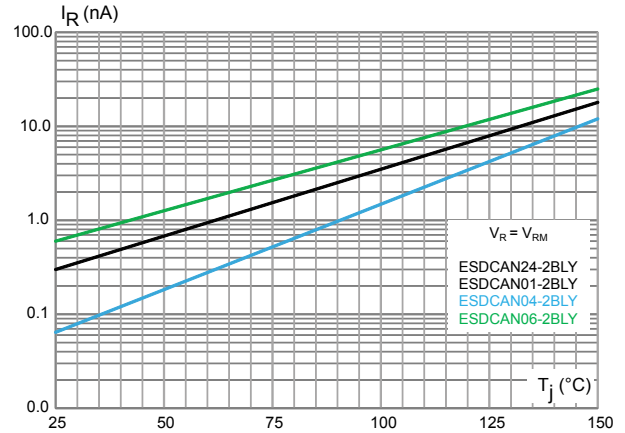

**Figure 7. Response to ISO 10605 -C = 150 pF, R = 330  $\Omega$  (-8 kV contact)**

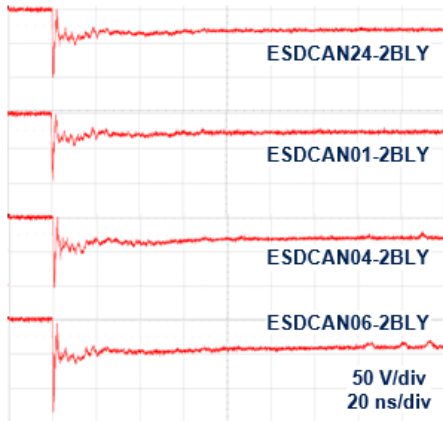

**Figure 8. Response to ISO 10605 - C = 150 pF, R = 330  $\Omega$  (+8 kV contact)**

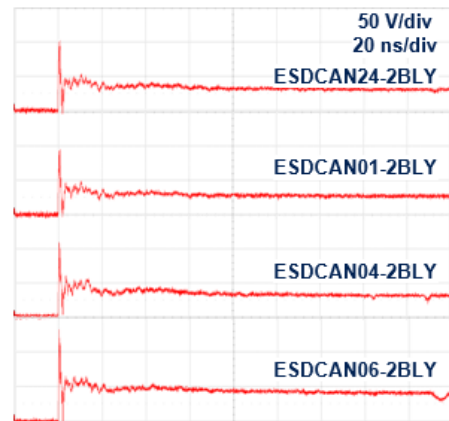

**Figure 9. Response to ISO 7637-3 Pulse 3a: -150 V**

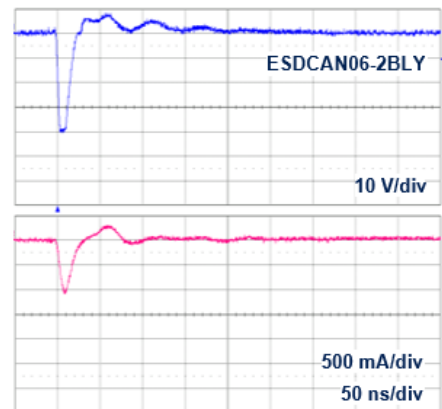
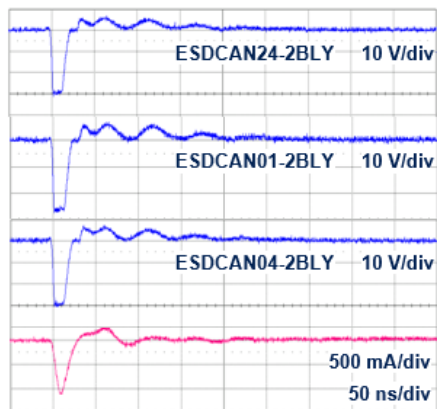

**Figure 10. Response to ISO 7637-3 Pulse 3b : +150 V**

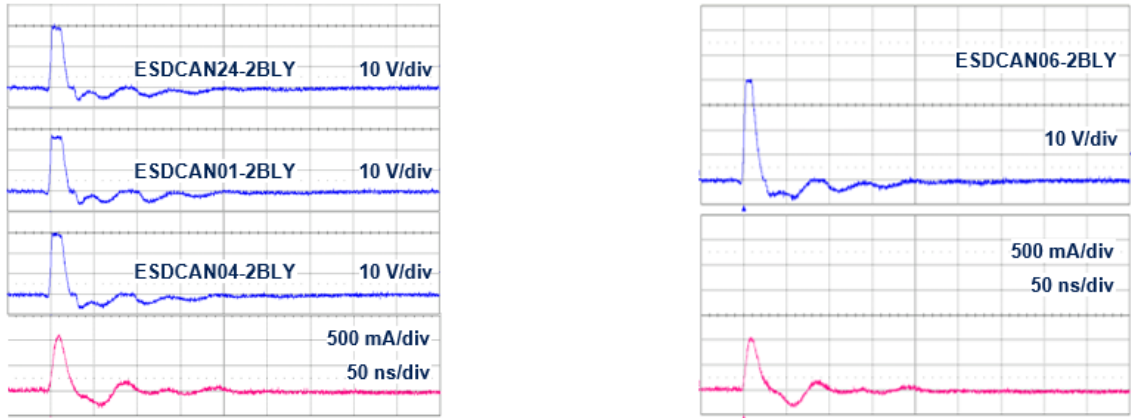

**Figure 11. Response to ISO 7637-3 pulse 2a: -85 V**

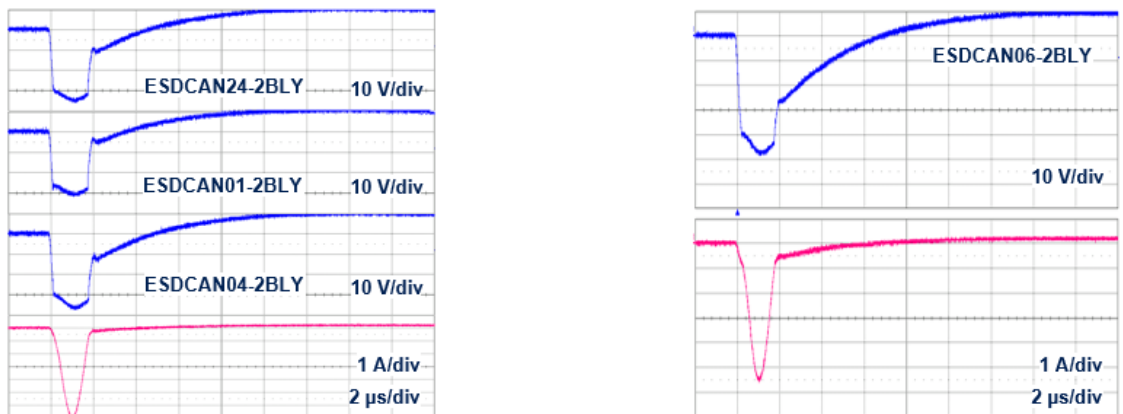

**Figure 12. Response to ISO 7637-3 pulse 2a: +85 V**

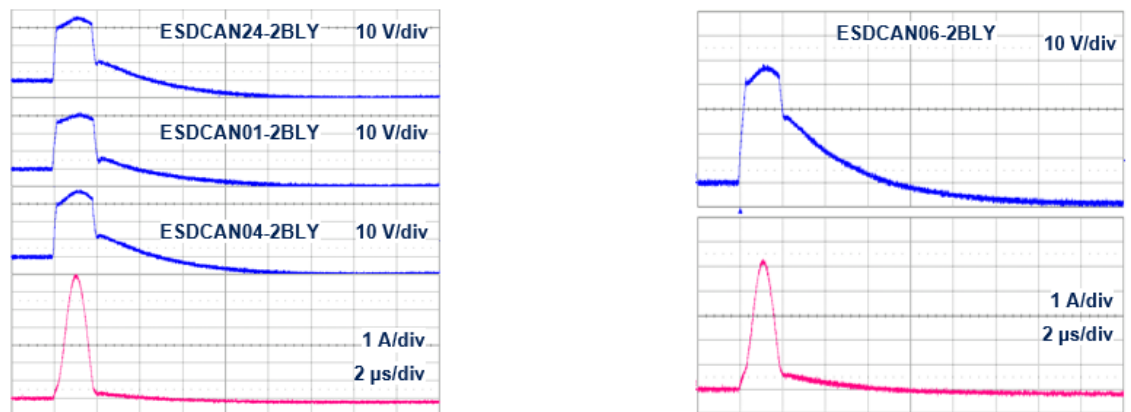

**Figure 13. S21 attenuation**

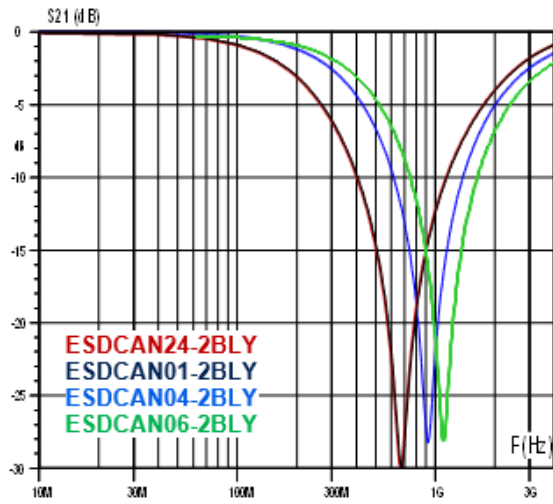

**Figure 14. TLP**

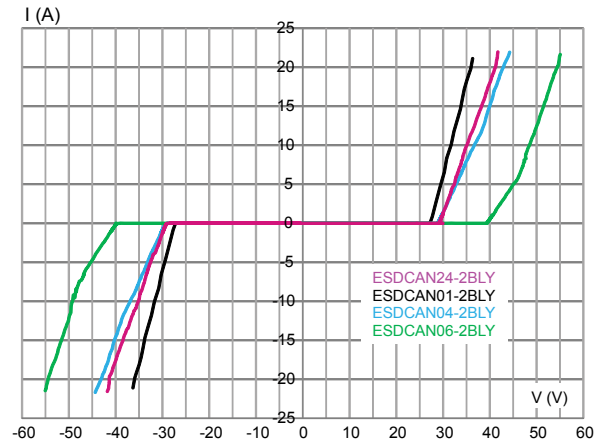

## 2 Package information

In order to meet environmental requirements, ST offers these devices in different grades of **ECOPACK** packages, depending on their level of environmental compliance. ECOPACK specifications, grade definitions and product status are available at: [www.st.com](http://www.st.com). ECOPACK is an ST trademark.

### 2.1 SOT23-3L package information

**Figure 15. SOT23-3L package outline**

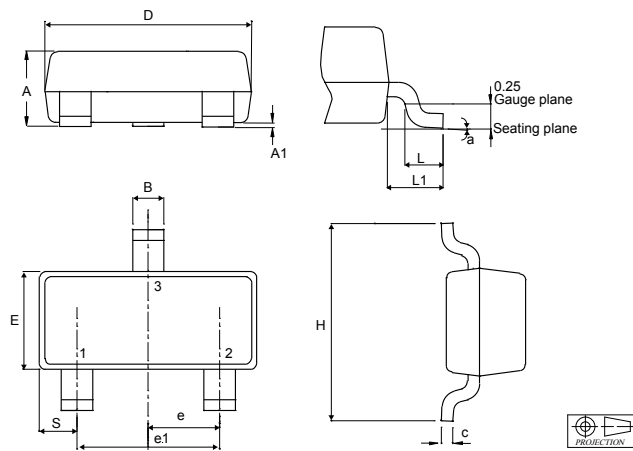

**Table 3. SOT23-3L package mechanical data**

Ref.	Dimensions					
	Millimeters			Inches <sup>(1)</sup>		
	Min.	Typ.	Max.	Min.	Typ.	Max.
A	0.89		1.25	0.0350		0.050
A1	0.00		0.15	0.0000		0.006
B	0.30		0.51	0.011		0.021
C	0.085		0.20	0.003		0.008
D	2.75		3.04	0.108		0.120
E	1.20		1.75	0.047		0.069
e	0.85	0.95	1.05	0.033	0.037	0.042
e1	1.70	1.90	2.10	0.066	0.075	0.083
H	2.10		3.00	0.082		0.119
L	0.25		0.61	0.009		0.025
L1		0.55			0.022	
S	0.35		0.65	0.013		0.026
a	0°		8°	0°		8°

1. Dimension in inches are given for reference only.



Figure 16. SOT23-3L marking

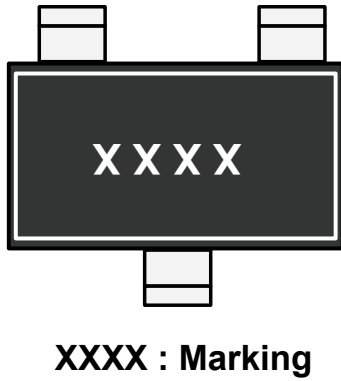

Figure 17. SOT23-3L footprint in mm

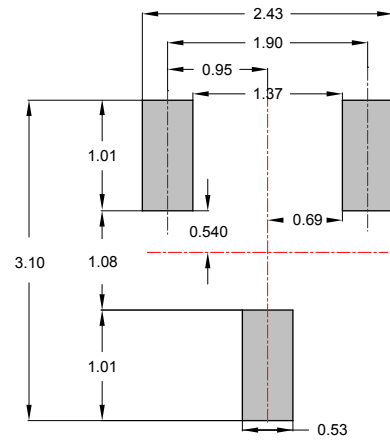
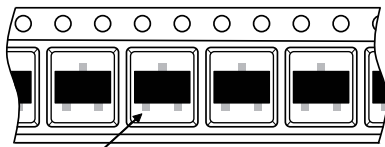

Figure 18. Package orientation in reel



Pin 1 located according to EIA-481

Note: Pocket dimensions are not on scale  
Pocket shape may vary depending on package

Figure 19. Tape and reel orientation

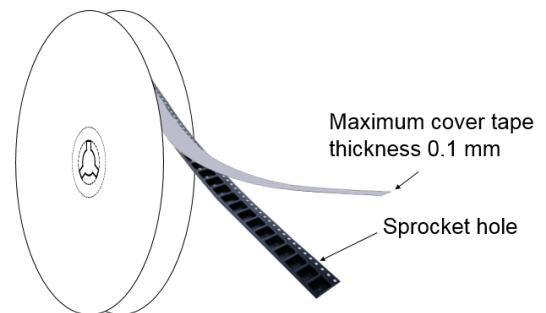

Figure 20. 7" reel dimension values

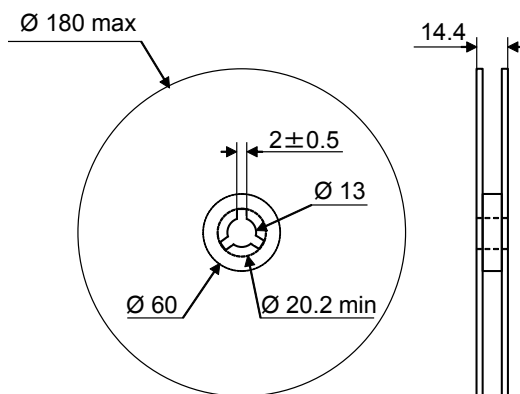

Figure 21. Inner box dimension values

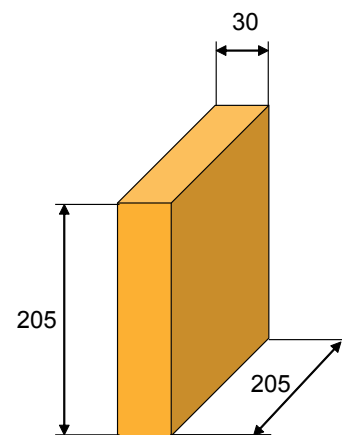
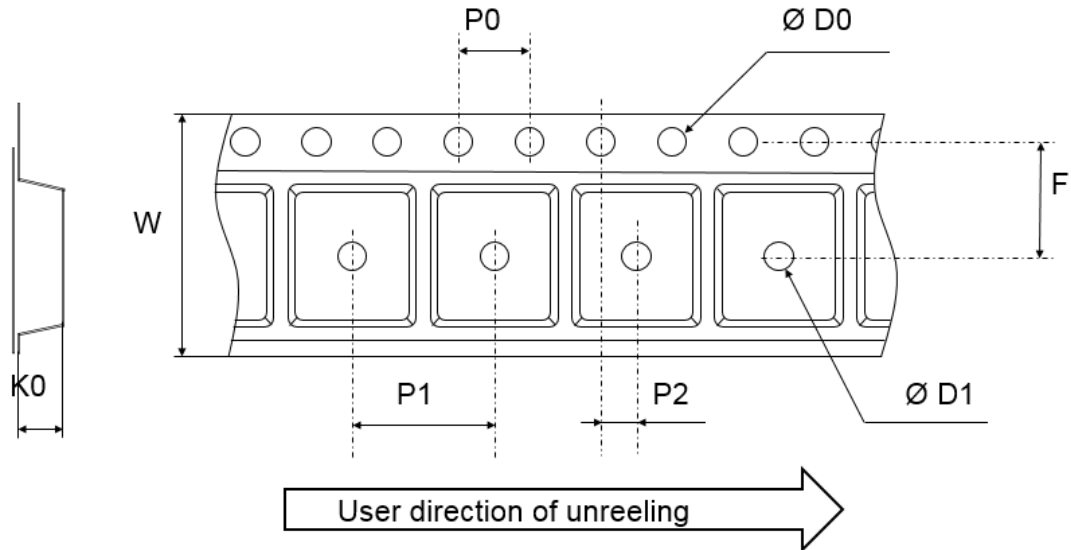

Figure 22. Tape outline



Note: Pocket dimensions are not on scale  
Pocket shape may vary depending on package

Table 4. Tape dimension values

Ref.	Dimensions		
	Millimeters		
	Min.	Typ.	Max.
D0	1.45	1.5	1.6
D1	1		
F	3.45	3.5	3.55
K0	1.3	1.4	1.5
P0	3.9	4.0	4.1
P1	3.9	4.0	4.1
P2	1.95	2.0	2.05
W	7.9	8	8.3

### 3 Reflow profile

Figure 23. ST ECOPACK® recommended soldering reflow profile for PCB mounting

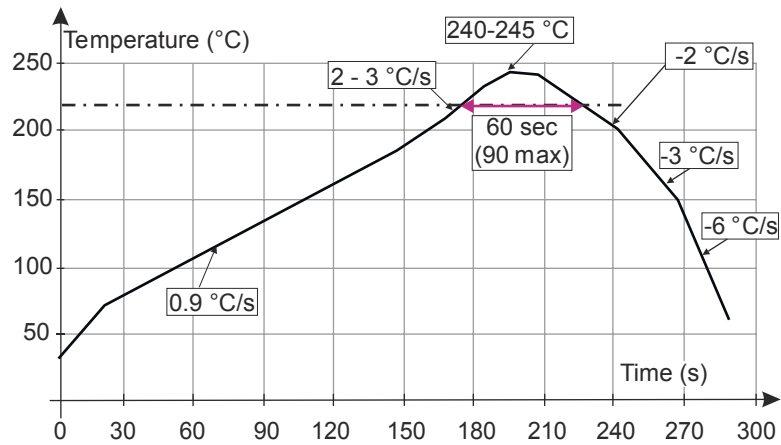

Note: Minimize air convection currents in the reflow oven to avoid component movement. Maximum soldering profile corresponds to the latest IPC/JEDEC J-STD-020.

## 4 Ordering information

Figure 24. Ordering information scheme

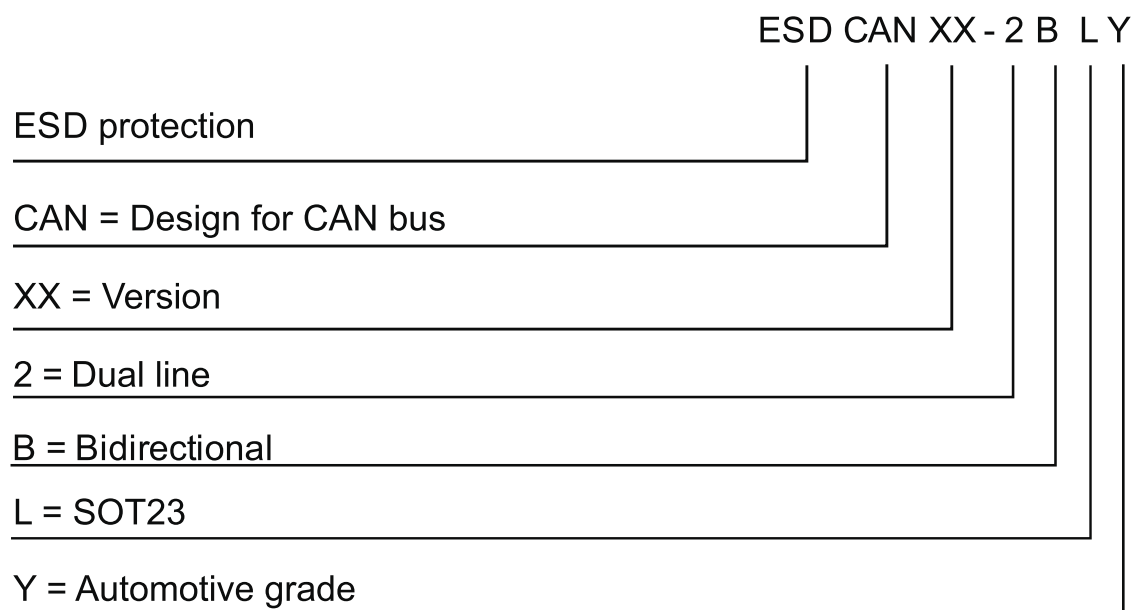

Table 5. Ordering information

Order code	Marking <sup>(1)</sup>	Package	Weight	Base qty.	Delivery mode
ESDCAN24-2BLY	EL24	SOT23-3L	9.8 mg	3000	Tape and reel
ESDCAN01-2BLY	EN24				
ESDCAN04-2BLY	EC24				
ESDCAN06-2BLY	EC35				

1. The marking can be rotated by multiples of 90° to differentiate assembly location

## Revision history

**Table 6. Document revision history**

Date	Revision	Changes
13-Jul-2015	1	First issue.
04-Oct-2018	2	Added RPN ESDCAN04-2BLY and ESDCAN06-2BLY. Updated cover page, <a href="#">Section 1 Characteristics</a> and <a href="#">Section 1.1 Characteristics (curves)</a> . Added Packing information.
05-Apr-2019	3	Added typical pitch in <a href="#">Table 3</a> and updated <a href="#">Figure 17</a> .

**IMPORTANT NOTICE – PLEASE READ CAREFULLY**

STMicroelectronics NV and its subsidiaries (“ST”) reserve the right to make changes, corrections, enhancements, modifications, and improvements to ST products and/or to this document at any time without notice. Purchasers should obtain the latest relevant information on ST products before placing orders. ST products are sold pursuant to ST’s terms and conditions of sale in place at the time of order acknowledgement.

Purchasers are solely responsible for the choice, selection, and use of ST products and ST assumes no liability for application assistance or the design of Purchasers’ products.

No license, express or implied, to any intellectual property right is granted by ST herein.

Resale of ST products with provisions different from the information set forth herein shall void any warranty granted by ST for such product.

ST and the ST logo are trademarks of ST. For additional information about ST trademarks, please refer to [www.st.com/trademarks](http://www.st.com/trademarks). All other product or service names are the property of their respective owners.

Information in this document supersedes and replaces information previously supplied in any prior versions of this document.

© 2019 STMicroelectronics – All rights reserved

# Mouser Electronics

Authorized Distributor

Click to View Pricing, Inventory, Delivery & Lifecycle Information:

[STMicroelectronics:](#)

[ESDCAN24-2BLY](#) [ESDCAN01-2BLY](#)