

LMV1031-20 Amplifier for Internal 3-Wire Analog Microphones and External Preamplifier

Check for Samples: [LMV1031](#)

FEATURES

- (Typical LMV1031-20, 2V Supply; Unless Otherwise Noted)
- Signal to Noise Ratio 62 dB
- Output Voltage Noise (A-Weighted) –86 dBV
- Low Supply Current 72 μ A
- Supply Voltage 2V to 5V
- Input Impedance >100 M Ω
- Max Input Signal 108 mV_{PP}
- Output Voltage 1.09V
- Temperature Range –40°C to 85°C
- Large Dome 4-Bump DSBGA Package with Improved Adhesion Technology

APPLICATIONS

- Mobile Communications - Bluetooth
- Accessory Microphone Products
- Cellular Phones
- PDAs

DESCRIPTION

The LMV1031 audio amplifier is an ideal replacement for the JFET preamplifier that is currently used in the electret microphones. The LMV1031 is optimized for applications that require extended battery life, such as Bluetooth communication links. The supply current for the LMV1031 is only 72 μ A. This is a dramatic reduction from that required for a JFET equipped microphone. The LMV1031, with its separate output and supply pins, offers a higher PSRR and eliminates the need for additional external components.

The LMV1031 is ensured to operate from 2V to 5V supply voltage over the full temperature range, has a fixed voltage gain of 20 dB and enhanced SNR performance. The LMV1031 is optimized for an output biasing of 1.09V.

The LMV1031 has less than 200 Ω of output impedance over the full audio bandwidth. The gain response of the LMV1031 is flat within the audio band and is stable over the temperature range.

The LMV1031 is available in a large dome 4-bump ultra thin DSBGA package that can easily fit on the PCB inside the miniature microphone metal can (package). This package is designed for microphone PCBs requiring 1 kg adhesion criteria.

Block Diagram

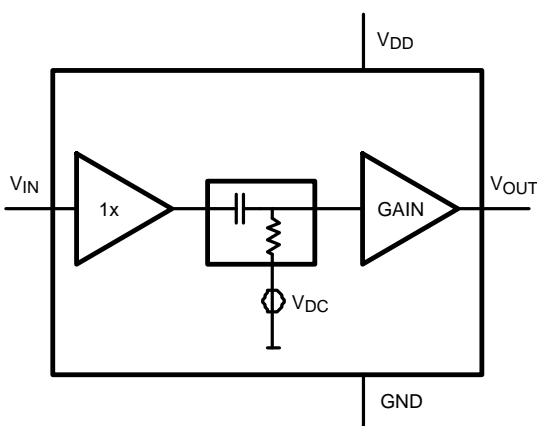

Electret Microphone

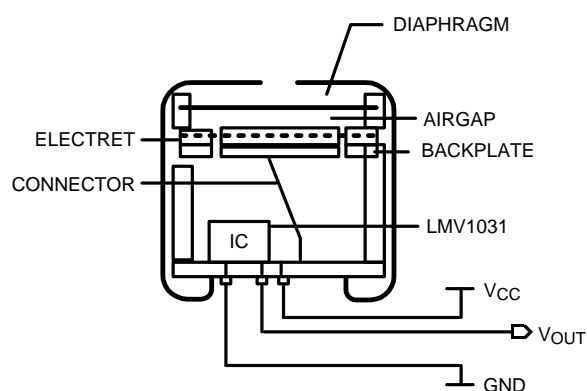

Please be aware that an important notice concerning availability, standard warranty, and use in critical applications of Texas Instruments semiconductor products and disclaimers thereto appears at the end of this data sheet.

All trademarks are the property of their respective owners.



These devices have limited built-in ESD protection. The leads should be shorted together or the device placed in conductive foam during storage or handling to prevent electrostatic damage to the MOS gates.

Absolute Maximum Ratings⁽¹⁾⁽²⁾

ESD Tolerance ⁽³⁾	Human Body Model	2500V
	Machine Model	250V
Supply Voltage V_{DD} - GND		5.5V
Storage Temperature Range		-65°C to 150°C
Junction Temperature ⁽⁴⁾		150°C max
Mounting Temperature	Infrared or Convection (20 sec.)	235°C

- (1) Absolute Maximum Ratings indicate limits beyond which damage to the device may occur. Operating Ratings indicate conditions for which the device is intended to be functional, but specific performance is not ensured. For specified specifications and the test conditions, see the Electrical Characteristics.
- (2) If Military/Aerospace specified devices are required, please contact the Texas Instruments Sales Office/Distributors for availability and specifications.
- (3) The human body model (HBM) is 1.5 k Ω in series with 100 pF. The machine model is 0 Ω in series with 200 pF.
- (4) The maximum power dissipation is a function of $T_{J(MAX)}$, θ_{JA} and T_A . The maximum allowable power dissipation at any ambient temperature is $P_D = (T_{J(MAX)} - T_A)/\theta_{JA}$. All numbers apply for packages soldered directly onto a PC board.

Operating Ratings⁽¹⁾

Supply Voltage	2V to 5V
Temperature Range	-40°C to +85°C

- (1) Absolute Maximum Ratings indicate limits beyond which damage to the device may occur. Operating Ratings indicate conditions for which the device is intended to be functional, but specific performance is not ensured. For specified specifications and the test conditions, see the Electrical Characteristics.

2V and 5V Electrical Characteristics⁽¹⁾

Unless otherwise specified, all limits are specified for $T_J = 25^\circ\text{C}$ and $V_{DD} = 2\text{V}$ and 5V . **Boldface** limits apply at the temperature extremes.

Symbol	Parameter	Conditions	Min ⁽²⁾	Typ ⁽³⁾	Max ⁽²⁾	Units
I_{DD}	Supply Current	$V_{IN} = \text{GND}$		72	90 100	μA
SNR	Signal to Noise Ratio	$f = 1 \text{ kHz}$, $V_{IN} = 18 \text{ mV}_{PP}$		62		dB
THD	Total Harmonic Distortion	$f = 1 \text{ kHz}$, $V_{IN} = 18 \text{ mV}_{PP}$		0.18		%
e_n	Output Noise	A-Weighted		-86		dBV
A_V	Gain	$f = 1 \text{ kHz}$, $V_{IN} = 18 \text{ mV}_{PP}$	19.18 19.00	20.1	20.90 21.00	dB
f_{LOW}	Lower -3 dB Roll Off Frequency	$R_{SOURCE} = 50\Omega$, $V_{IN} = 18 \text{ mV}_{PP}$		72		Hz
f_{HIGH}	Upper -3 dB Roll Off Frequency	$R_{SOURCE} = 50\Omega$, $V_{IN} = 18 \text{ mV}_{PP}$		52		kHz
V_{IN}	Max Input Signal	$f = 1 \text{ kHz}$ and $\text{THD+N} < 1\%$		108		mV_{PP}
Z_{IN}	Input Impedance			>100		$\text{M}\Omega$
C_{IN}	Input Capacitance			2		pF
V_{OUT}	Output Voltage	$V_{IN} = \text{GND}$	890 875	1090	1310 1325	mV
R_O	Output Impedance	$f = 1 \text{ kHz}$		<200		Ω
PSRR	Power Supply Rejection Ratio	$2\text{V} < V_{DD} < 5\text{V}$		56		dB

- (1) Electrical table values apply only for factory testing conditions at the temperature indicated. Factory testing conditions result in very limited self-heating of the device such that $T_J = T_A$. No ensuring of parametric performance is indicated in the electrical tables under conditions of internal self-heating where $T_J > T_A$.
- (2) All limits are specified by design or statistical analysis.
- (3) Typical values represent the most likely parametric norm at the time of characterization.

Connection Diagram

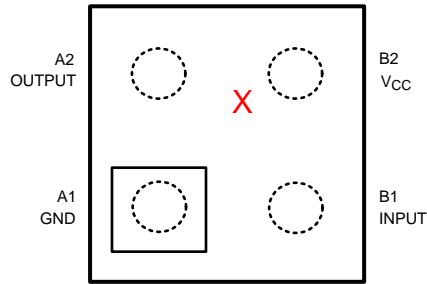

Note:

- Pin numbers are referenced to package marking text orientation.
- The actual physical placement of the package marking will vary slightly from part to part. The package will designate the date code and will vary considerably. Package marking does not correlate to device type in any way.

**Figure 1. 4-Bump Ultra Thin DSBGA
Top View**

Typical Performance Characteristics

Unless otherwise specified, $V_S = 2V$, single supply, $T_A = 25^\circ C$

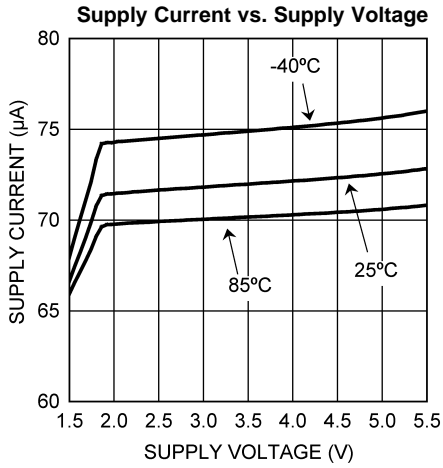

Figure 2.

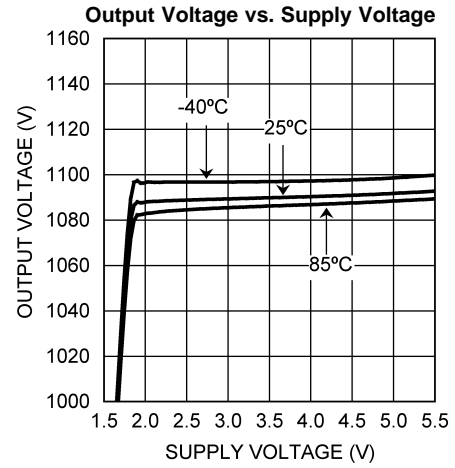

Figure 3.

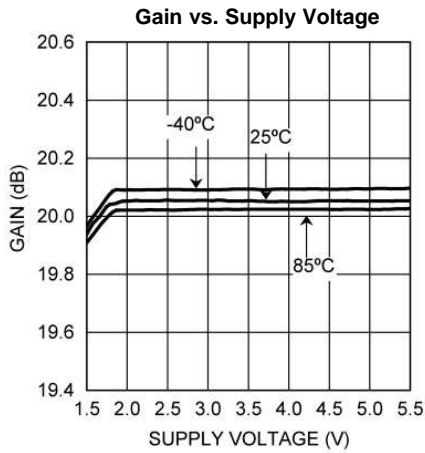

Figure 4.

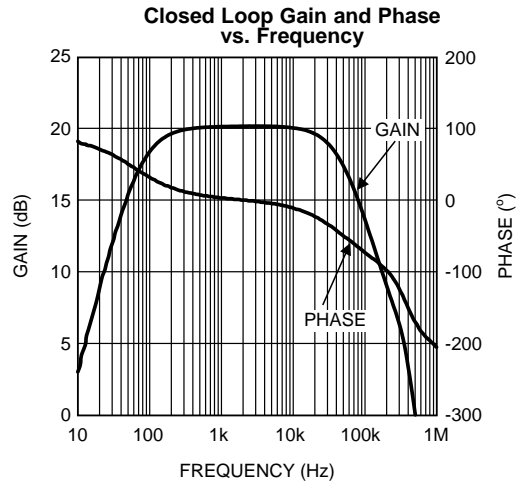

Figure 5.

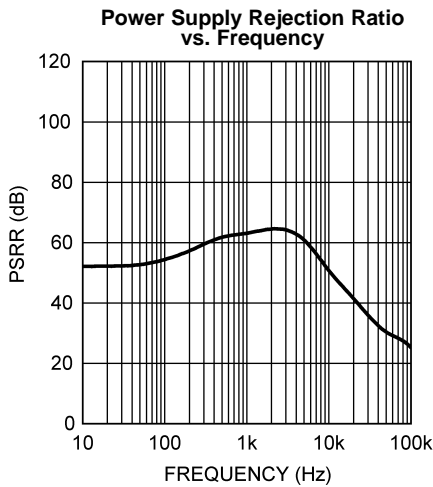

Figure 6.

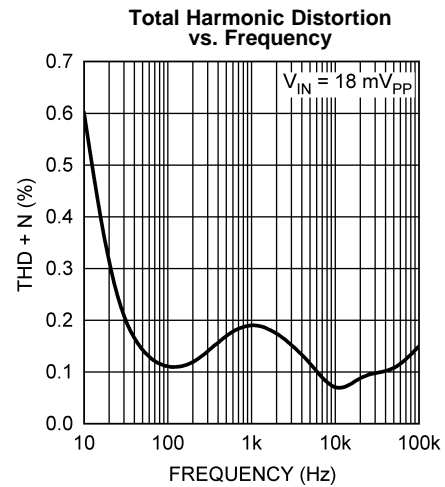

Figure 7.

Typical Performance Characteristics (continued)

Unless otherwise specified, $V_S = 2V$, single supply, $T_A = 25^\circ C$

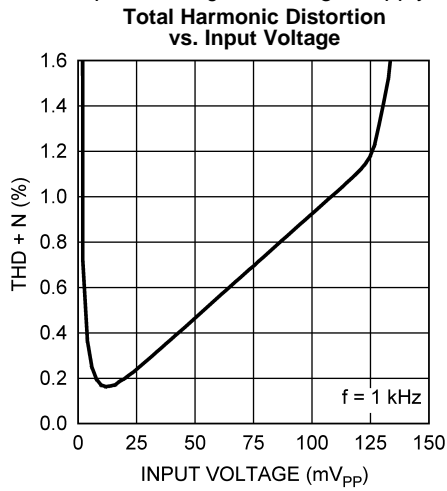

Figure 8.

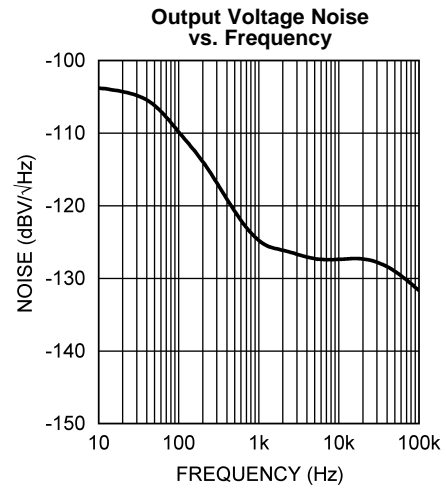

Figure 9.

APPLICATION SECTION

LOW CURRENT

The LMV1031 has a low supply current which allows for a longer battery life. The low supply current of 72 μA makes this amplifier optimal for microphone applications which need to be always on.

BUILT-IN GAIN

The LMV1031 is offered in the space saving small DSBGA package which fits perfectly into the metal can of a microphone. This allows the LMV1031 to be placed on the PCB inside the microphone.

The bottom side of the PCB has the pins that connect the supply voltage to the amplifier and make the output available. The input of the amplifier is connected to the microphone via the PCB.

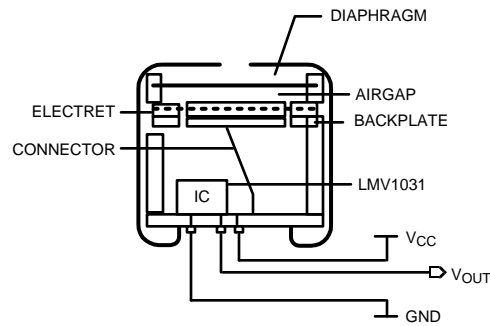

Figure 10. Built-in Gain

EXTERNAL PREAMPLIFIER APPLICATION

The LMV1031 can also be used outside of an ECM as a space saving external preamplifier. In this application, the LMV1031 follows a phantom biased JFET microphone in the circuit. This is shown in Figure 11. The input of the LMV1031 is connected to the microphone via a 2.2 μF capacitor. The advantages of this circuit over one with only a JFET microphone are the additional gain and the high pass filter supplied by the LMV1031. The high pass filter makes the output signal more robust and less sensitive to low frequency disturbances. In this configuration the LMV1031 should be placed as close as possible to the microphone.

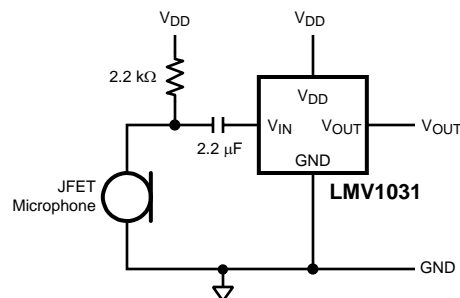

Figure 11. LMV1031 as external preamplifier

A-WEIGHTED FILTER

The human ear has a frequency range from 20 Hz to about 20 kHz. Within this range the sensitivity of the human ear is not equal for each frequency. To approach the hearing response weighting filters are introduced. One of those filters is the A-weighted filter.

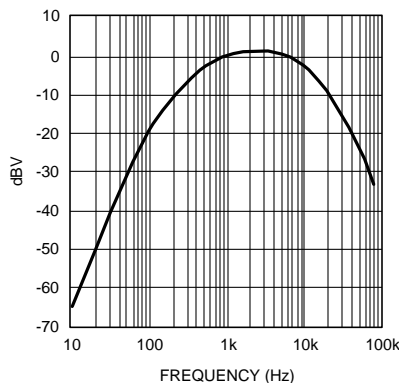

Figure 12. A-Weighted Filter

The A-weighted filter is commonly used in signal-to-noise ratio measurements, where sound is compared to device noise. It improves the correlation of the measured data to the signal-to-noise ratio perceived by the human ear.

OUTPUT CURRENT

The LMV1031 is designed for driving high ohmic loads with several milli amperes of output current. Figure 13 shows the gain performance of the LMV1031 versus the sinking and sourcing current. The gain remains constant within the shown output current range. This sets the operating range of the LMV1031 with respect to the output current.

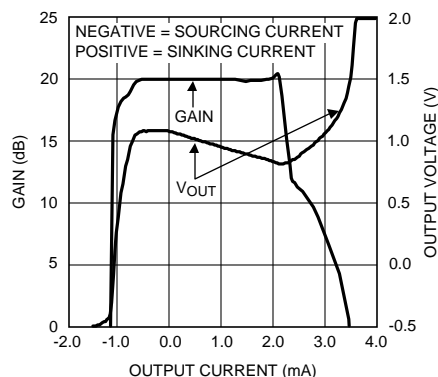

Figure 13. Performance vs. Output Current

MEASURING NOISE AND SNR

The overall noise of the LMV1031 is measured within the frequency band from 10 Hz to 22 kHz using an A-weighted filter. The input of the LMV1031 is connected to ground with a 5 pF capacitor.

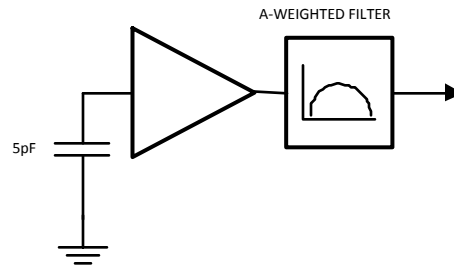

Figure 14. Noise Measurement Setup

The signal-to-noise ratio (SNR) is measured with a 1 kHz input signal of 18 mV_{pp} using an A-weighted filter. This represents a sound pressure level of 94 dB with a standard ECM sensitivity. No input capacitor is connected.

SOUND PRESSURE LEVEL

The volume of sound applied to a microphone is commonly stated as the pressure level with respect to the threshold of hearing of the human ear. This sound pressure level (SPL) in decibels is defined by:

$$\text{Sound pressure level (dB)} = 20 \log P_m/P_0$$

where

- P_m is the measured sound pressure
- P_0 is the threshold of hearing (20 μ Pa)

In order to be able to calculate the resulting output voltage of the microphone for a given SPL, the sound pressure in dB SPL needs to be converted to the absolute sound pressure in dBPa. This is the sound pressure level in decibels which is referred to 1 Pascal (Pa).

The conversion is given by:

$$\text{dBPa} = \text{dB SPL} + 20 \cdot \log 20 \mu\text{Pa}$$

$$\text{dBPa} = \text{dB SPL} - 94 \text{ dB}$$

Translation from absolute sound pressure level to a voltage is specified by the sensitivity of the microphone. A conventional microphone has a sensitivity of -44 dBV/Pa .

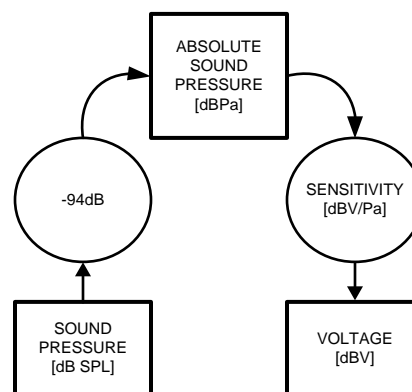

Figure 15. dB SPL to dBV Conversion

Example: Busy traffic is 70 dB

$$V_{OUT} = 70 - 94 - 44 = -68 \text{ dBV}$$

This is equivalent to 1.13 mV_{PP}

Since the LMV1031-20 has a gain of 10 times (20 dB) over the JFET, the output voltage of the microphone is 11.3 mV_{PP}. By replacing the JFET with the LMV1031-20, the sensitivity of the microphone is -24 dBV/Pa (-44 + 20).

LOW FREQUENCY CUT-OFF FILTER

The LMV1031 has a low cut-off filter on the output of the microphone, to reduce low frequency noises, such as wind and vibration. This also helps to reduce the proximity effect in directional microphones. This effect occurs when the sound source is very close to the microphone. The lower frequencies are amplified which gives a bass sound. This amplification can cause an overload, which results in a distortion of the signal.

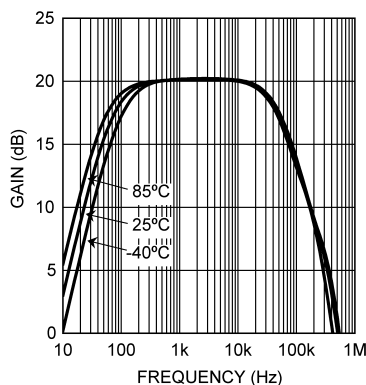

Figure 16. Gain vs. Frequency

The LMV1031 is optimized to be used in audio band applications. As shown in Figure 16, the LMV1031 provides a flat gain response within the audio band and offers excellent temperature stability.

ADVANTAGE OF THREE PINS

When implemented in an Electret Condenser Microphone (ECM) the LMV1031 adds the advantages of a three pin configuration. The third pin provides a low supply current, higher PSRR, and eliminates the need for additional external components.

It is well known that cell phone microphones are sensitive to noise pick-up. A conventional JFET circuit is sensitive to noise pick-up because of its high output impedance, which is usually around 2.2 kΩ. The LMV1031 is less sensitive to noise pick-up because it provides separate output and supply pins. Using separate pins greatly reduces the output impedance.

REVISION HISTORY

Changes from Revision A (May 2013) to Revision B	Page
• Changed layout of National Data Sheet to TI format	9

PACKAGING INFORMATION

Orderable Device	Status (1)	Package Type	Package Drawing	Pins	Package Qty	Eco Plan (2)	Lead/Ball Finish	MSL Peak Temp (3)	Op Temp (°C)	Top-Side Markings (4)	Samples
LMV1031UR-20/NOPB	ACTIVE	DSBGA	YPD	4	250	Green (RoHS & no Sb/Br)	SNAGCU	Level-1-260C-UNLIM			Samples
LMV1031URX-20/NOPB	ACTIVE	DSBGA	YPD	4	3000	Green (RoHS & no Sb/Br)	SNAGCU	Level-1-260C-UNLIM	-40 to 85		Samples

(1) The marketing status values are defined as follows:

ACTIVE: Product device recommended for new designs.

LIFEBUY: TI has announced that the device will be discontinued, and a lifetime-buy period is in effect.

NRND: Not recommended for new designs. Device is in production to support existing customers, but TI does not recommend using this part in a new design.

PREVIEW: Device has been announced but is not in production. Samples may or may not be available.

OBSOLETE: TI has discontinued the production of the device.

(2) Eco Plan - The planned eco-friendly classification: Pb-Free (RoHS), Pb-Free (RoHS Exempt), or Green (RoHS & no Sb/Br) - please check <http://www.ti.com/productcontent> for the latest availability information and additional product content details.

TBD: The Pb-Free/Green conversion plan has not been defined.

Pb-Free (RoHS): TI's terms "Lead-Free" or "Pb-Free" mean semiconductor products that are compatible with the current RoHS requirements for all 6 substances, including the requirement that lead not exceed 0.1% by weight in homogeneous materials. Where designed to be soldered at high temperatures, TI Pb-Free products are suitable for use in specified lead-free processes.

Pb-Free (RoHS Exempt): This component has a RoHS exemption for either 1) lead-based flip-chip solder bumps used between the die and package, or 2) lead-based die adhesive used between the die and leadframe. The component is otherwise considered Pb-Free (RoHS compatible) as defined above.

Green (RoHS & no Sb/Br): TI defines "Green" to mean Pb-Free (RoHS compatible), and free of Bromine (Br) and Antimony (Sb) based flame retardants (Br or Sb do not exceed 0.1% by weight in homogeneous material)

(3) MSL, Peak Temp. -- The Moisture Sensitivity Level rating according to the JEDEC industry standard classifications, and peak solder temperature.

(4) Multiple Top-Side Markings will be inside parentheses. Only one Top-Side Marking contained in parentheses and separated by a "~" will appear on a device. If a line is indented then it is a continuation of the previous line and the two combined represent the entire Top-Side Marking for that device.

Important Information and Disclaimer: The information provided on this page represents TI's knowledge and belief as of the date that it is provided. TI bases its knowledge and belief on information provided by third parties, and makes no representation or warranty as to the accuracy of such information. Efforts are underway to better integrate information from third parties. TI has taken and continues to take reasonable steps to provide representative and accurate information but may not have conducted destructive testing or chemical analysis on incoming materials and chemicals. TI and TI suppliers consider certain information to be proprietary, and thus CAS numbers and other limited information may not be available for release.

In no event shall TI's liability arising out of such information exceed the total purchase price of the TI part(s) at issue in this document sold by TI to Customer on an annual basis.

TAPE AND REEL INFORMATION



QUADRANT ASSIGNMENTS FOR PIN 1 ORIENTATION IN TAPE



*All dimensions are nominal

Device	Package Type	Package Drawing	Pins	SPQ	Reel Diameter (mm)	Reel Width W1 (mm)	A0 (mm)	B0 (mm)	K0 (mm)	P1 (mm)	W (mm)	Pin1 Quadrant
LMV1031UR-20/NOPB	DSBGA	YPD	4	250	178.0	8.4	1.22	1.22	0.56	4.0	8.0	Q1
LMV1031URX-20/NOPB	DSBGA	YPD	4	3000	178.0	8.4	1.22	1.22	0.56	4.0	8.0	Q1

TAPE AND REEL BOX DIMENSIONS

*All dimensions are nominal

Device	Package Type	Package Drawing	Pins	SPQ	Length (mm)	Width (mm)	Height (mm)
LMV1031UR-20/NOPB	DSBGA	YPD	4	250	210.0	185.0	35.0
LMV1031URX-20/NOPB	DSBGA	YPD	4	3000	210.0	185.0	35.0

YPD0004

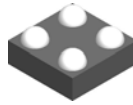

PACKAGE OUTLINE

DSBGA - 0.395 mm max height

DIE SIZE BALL GRID ARRAY

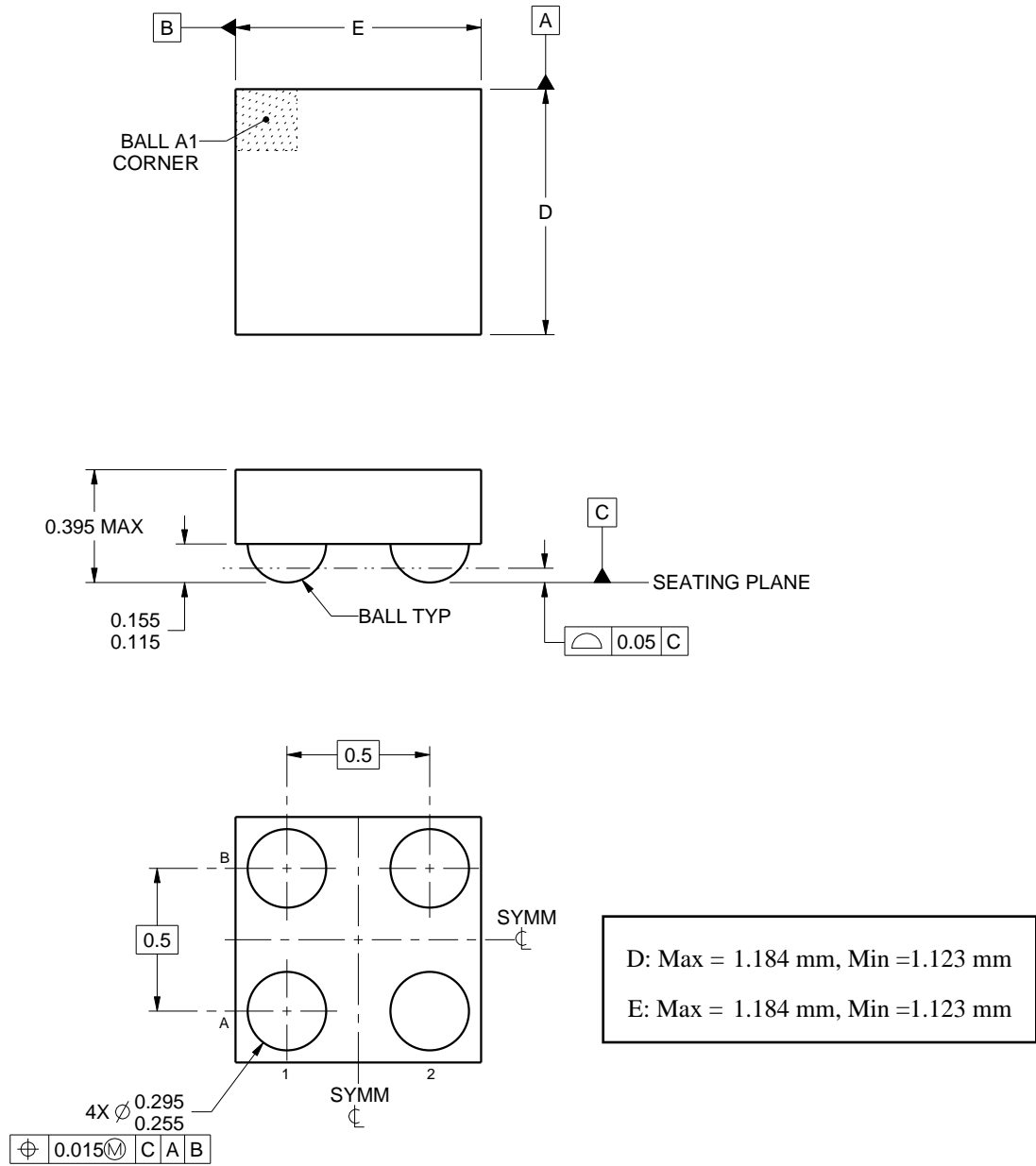

4215141/B 08/2016

NOTES:

1. All linear dimensions are in millimeters. Any dimensions in parenthesis are for reference only. Dimensioning and tolerancing per ASME Y14.5M.
2. This drawing is subject to change without notice.

EXAMPLE BOARD LAYOUT

YPD0004

DSBGA - 0.395 mm max height

DIE SIZE BALL GRID ARRAY

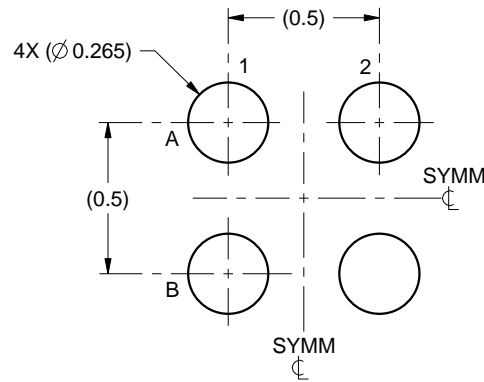

LAND PATTERN EXAMPLE
SCALE:40X

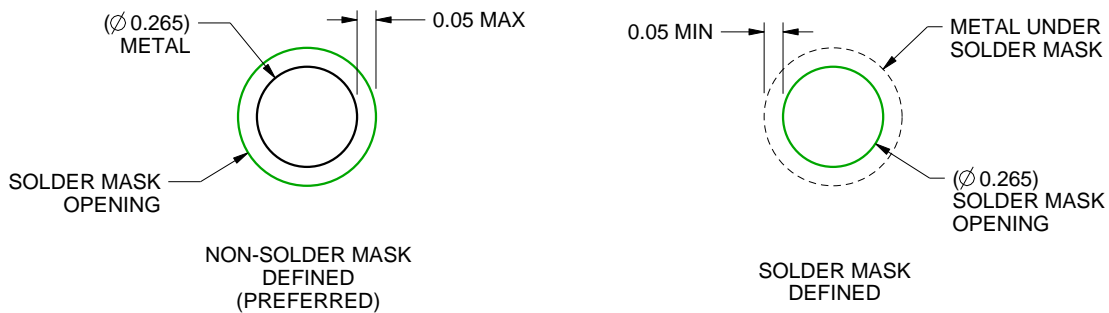

SOLDER MASK DETAILS
NOT TO SCALE

4215141/B 08/2016

NOTES: (continued)

3. Final dimensions may vary due to manufacturing tolerance considerations and also routing constraints. See Texas Instruments Literature No. SNVA009 (www.ti.com/lit/snva009).

EXAMPLE STENCIL DESIGN

YPD0004

DSBGA - 0.395 mm max height

DIE SIZE BALL GRID ARRAY

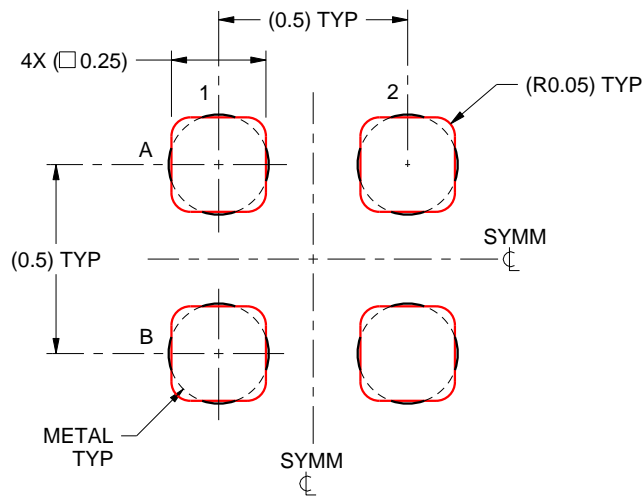

SOLDER PASTE EXAMPLE
BASED ON 0.1 mm THICK STENCIL
SCALE:50X

4215141/B 08/2016

NOTES: (continued)

4. Laser cutting apertures with trapezoidal walls and rounded corners may offer better paste release.

IMPORTANT NOTICE AND DISCLAIMER

TI PROVIDES TECHNICAL AND RELIABILITY DATA (INCLUDING DATASHEETS), DESIGN RESOURCES (INCLUDING REFERENCE DESIGNS), APPLICATION OR OTHER DESIGN ADVICE, WEB TOOLS, SAFETY INFORMATION, AND OTHER RESOURCES "AS IS" AND WITH ALL FAULTS, AND DISCLAIMS ALL WARRANTIES, EXPRESS AND IMPLIED, INCLUDING WITHOUT LIMITATION ANY IMPLIED WARRANTIES OF MERCHANTABILITY, FITNESS FOR A PARTICULAR PURPOSE OR NON-INFRINGEMENT OF THIRD PARTY INTELLECTUAL PROPERTY RIGHTS.

These resources are intended for skilled developers designing with TI products. You are solely responsible for (1) selecting the appropriate TI products for your application, (2) designing, validating and testing your application, and (3) ensuring your application meets applicable standards, and any other safety, security, or other requirements. These resources are subject to change without notice. TI grants you permission to use these resources only for development of an application that uses the TI products described in the resource. Other reproduction and display of these resources is prohibited. No license is granted to any other TI intellectual property right or to any third party intellectual property right. TI disclaims responsibility for, and you will fully indemnify TI and its representatives against, any claims, damages, costs, losses, and liabilities arising out of your use of these resources.

TI's products are provided subject to TI's Terms of Sale (www.ti.com/legal/termsofsale.html) or other applicable terms available either on ti.com or provided in conjunction with such TI products. TI's provision of these resources does not expand or otherwise alter TI's applicable warranties or warranty disclaimers for TI products.

Mailing Address: Texas Instruments, Post Office Box 655303, Dallas, Texas 75265
Copyright © 2020, Texas Instruments Incorporated