

## Broadband, Fully-Differential, 14-/16-Bit ADC DRIVER AMPLIFIER

Check for Samples: [THS770006](#)

### FEATURES

- **2.4GHz Bandwidth**
- **3100V/ $\mu$ s Slew Rate,  $V_{OUT} = 2V$  Step**
- **Fixed Voltage Gain: +6dB**
- **IMD<sub>3</sub>: -107dBc,  $V_{OUT} = 2V_{PP}$ ,  $R_L = 400\Omega$ ,  $f = 100MHz$**
- **OIP3: 48dBm,  $f = 100MHz$**
- **Noise Figure: 11dB,  $f = 100MHz$**

### APPLICATIONS

- **14-/16-bit ADC Driver**
- **ADC Driver for Wireless Base Station Signal Chains: GSM, WCDMA, MC-GSM**
- **ADC Driver for High Dynamic Range Test and Measurement Equipment**

**THS770006 Driving 16-Bit ADC**

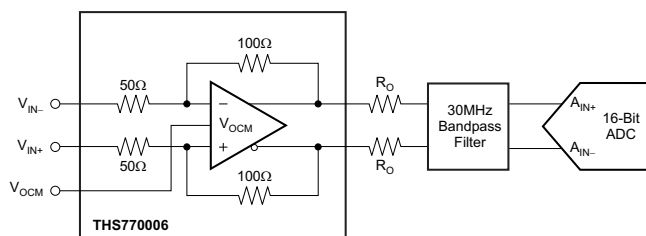

**FFT Plot with Two-Tone Input at 96MHz and 100MHz (see [Application Information](#) section).**

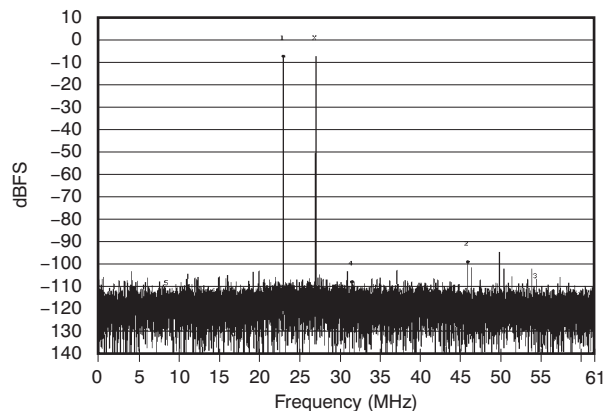

### DESCRIPTION

The THS770006 is a fixed-gain of +6dB, wideband, fully-differential amplifier designed and optimized specifically for driving 16-bit analog-to-digital converters (ADCs) at input frequencies up to 130MHz, and 14-bit ADCs at input frequencies up to 200MHz. This device provides high bandwidth, high-voltage output with low distortion and low noise, critical in high-speed data acquisition systems that require very high dynamic range, such as wireless base stations and test and measurement applications. This device also makes an excellent differential amplifier for general-purpose, high-speed differential signal chain and short line driver applications.

The THS770006 operates on a nominal +5V single supply, offers very fast, 7.5ns maximum recovery time from overdrive conditions, and has a power-down mode for power saving. The THS770006 is offered in a Pb-free (RoHS compliant) and green, QFN-24 thermally-enhanced package. It is characterized for operation over the industrial temperature range of -40°C to +85°C.

### RELATED DEVICES

| DEVICE                             | DESCRIPTION  |
|------------------------------------|--|
| <a href="#">THS4509</a>            | Wideband, low-noise, low-distortion, fully-differential amplifier                              |
| <a href="#">PGA870</a>             | Wideband, low-noise, low-distortion, fully-differential, digitally-programmable gain amplifier |
| <a href="#">ADS5481 to ADS5485</a> | 16-bit, 80MSPS to 200MSPS ADCs   |
| <a href="#">ADS6145</a>            | 14-bit, 125MSPS ADC  |
| <a href="#">ADS6149</a>            | 14-bit, 250MSPS ADC  |



Please be aware that an important notice concerning availability, standard warranty, and use in critical applications of Texas Instruments semiconductor products and disclaimers thereto appears at the end of this data sheet.

PowerPAD is a trademark of Texas Instruments.

All other trademarks are the property of their respective owners.



This integrated circuit can be damaged by ESD. Texas Instruments recommends that all integrated circuits be handled with appropriate precautions. Failure to observe proper handling and installation procedures can cause damage.

ESD damage can range from subtle performance degradation to complete device failure. Precision integrated circuits may be more susceptible to damage because very small parametric changes could cause the device not to meet its published specifications.

**PACKAGE/ORDERING INFORMATION<sup>(1)</sup>**

| PRODUCT   | PACKAGE TYPE | PACKAGE DESIGNATOR | SPECIFIED TEMPERATURE RANGE | PACKAGE MARKING | ORDERING NUMBER | TRANSPORT MEDIA, QUANTITY |
|-----------|--------------|--------------------|-----------------------------|-----------------|-----------------|---------------------------|
| THS770006 | VQFN-24      | RGE                | –40°C to +85°C              | THS770006IGRE   | THS770006IRGET  | Tape and reel, 250        |
|           |              |                    |                             | THS770006IGRE   | THS770006IRGER  | Tape and reel, 3000       |

(1) For the most current package and ordering information see the Package Option Addendum at the end of this document, or visit the device product folder on [www.ti.com](http://www.ti.com).

**DEVICE MARKING INFORMATION**

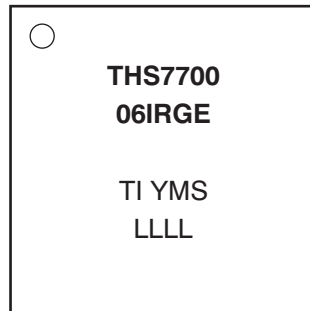

○ = Pin 1 designator  
 THS770006IRGE = device name  
 TI = TI LETTERS  
 YM = YEAR MONTH DATE CODE  
 S = ASSEMBLY SITE CODE  
 LLLL = ASSY LOT CODE

**ABSOLUTE MAXIMUM RATINGS<sup>(1)</sup>**

Over operating free-air temperature range, unless otherwise noted.

|   | THS770006                  | UNIT |
|---|----------------------------|------|
| Power supply (V <sub>S+</sub> to GND)                                     | 5.5                        | V    |
| Input voltage range   | Ground to V <sub>S+</sub>  | V    |
| Differential input voltage, V <sub>ID</sub>                               | Ground to V <sub>S+</sub>  | V    |
| Continuous input current, I <sub>I</sub>                                  | 10                         | mA   |
| Continuous output current, I <sub>O</sub>                                 | 100                        | mA   |
| Storage temperature range, T <sub>stg</sub>                               | –40°C to +125°C            | °C   |
| Maximum junction temperature, T <sub>J</sub>                              | +150                       | °C   |
| Maximum junction temperature, continuous operation, long term reliability | +125                       | °C   |
| ESD ratings   | Human body model (HBM)     | 2500 |
|   | Charged device model (CDM) | 1000 |
|   | Machine model (MM)         | 100  |

(1) Stresses above these ratings may cause permanent damage. Exposure to absolute maximum conditions for extended periods may degrade device reliability. These are stress ratings only, and functional operation of the device at these or any other conditions beyond those specified is not implied.

## THERMAL INFORMATION

| THERMAL METRIC <sup>(1)</sup> |  | THS770006 | UNITS |
|-------------------------------|--|-----------|-------|
|                               |  | RGE       |       |
|                               |  | 24 PINS   |       |
| $\theta_{JA}$                 | Junction-to-ambient thermal resistance       | 44.1      | °C/W  |
| $\theta_{JC(top)}$            | Junction-to-case(top) thermal resistance     | 35        |       |
| $\theta_{JB}$                 | Junction-to-board thermal resistance         | 19        |       |
| $\Psi_{JT}$                   | Junction-to-top characterization parameter   | 0.5       |       |
| $\Psi_{JB}$                   | Junction-to-board characterization parameter | 18.8      |       |
| $\theta_{JC(bottom)}$         | Junction-to-case(bottom) thermal resistance  | 8.9       |       |

(1) For more information about traditional and new thermal metrics, see the *IC Package Thermal Metrics* application report, [SPRA953](#).

## ELECTRICAL CHARACTERISTICS

Test conditions are at  $T_A = +25^\circ\text{C}$ ,  $V_{S+} = +5\text{V}$ ,  $V_{OCM} = +2.5\text{V}$ ,  $V_{OUT} = 2V_{PP}$ ,  $R_L = 400\Omega$  differential,  $G = +6\text{dB}$ , differential input and output, and input and output referenced to midsupply, unless otherwise noted. Measured using evaluation module as discussed in [Test Circuits](#) section.

| PARAMETER                               | TEST CONDITIONS   | MIN               | TYP  | MAX | UNIT             | TEST LEVEL <sup>(1)</sup> |
|---|---|-------------------|------|-----|------------------|---------------------------|
| <b>AC PERFORMANCE</b>                   |   |                   |      |     |                  |                           |
| Small-signal bandwidth                  | $V_{OUT} = 200\text{mV}_{PP}$                                 |                   | 2.4  |     | GHz              | C                         |
| Large-signal bandwidth                  | $V_{OUT} = 2V_{PP}$   |                   | 780  |     | MHz              | C                         |
|   | $V_{OUT} = 3V_{PP}$   |                   | 485  |     | MHz              | C                         |
| Bandwidth for 0.1dB flatness            | $V_{OUT} = 2V_{PP}$   |                   | 360  |     | MHz              | C                         |
|   | $V_{OUT} = 3V_{PP}$   |                   | 325  |     | MHz              | C                         |
| Slew rate                               | $V_{OUT} = 2\text{V step}$                                    |                   | 3100 |     | V/ $\mu\text{s}$ | C                         |
|   | $V_{OUT} = 4\text{V step}$                                    |                   | 3200 |     | V/ $\mu\text{s}$ | C                         |
| Rise time                               | $V_{OUT} = 2\text{V step}$                                    |                   | 0.6  |     | ns               | C                         |
| Fall time                               | $V_{OUT} = 2\text{V step}$                                    |                   | 0.6  |     | ns               | C                         |
| Settling time to 0.1%                   | $V_{OUT} = 2\text{V step}$                                    |                   | 2.2  |     | ns               | C                         |
| Input return loss, s11                  | See <a href="#">s-Parameters</a> section, $f < 200\text{MHz}$ |                   | -20  |     | dB               | C                         |
| Output return loss, s22                 | See <a href="#">s-Parameters</a> section, $f < 200\text{MHz}$ |                   | -20  |     | dB               | C                         |
| Reverse isolation, s12                  | See <a href="#">s-Parameters</a> section, $f < 200\text{MHz}$ |                   | -70  |     | dB               | C                         |
| Second-order harmonic distortion        | $f = 10\text{MHz}$  |                   | -87  |     | dBc              | C                         |
|   | $f = 50\text{MHz}$  |                   | -81  |     | dBc              | C                         |
|   | $f = 100\text{MHz}$   |                   | -78  |     | dBc              | C                         |
|   | $f = 200\text{MHz}$   |                   | -74  |     | dBc              | C                         |
| Third-order harmonic distortion         | $f = 10\text{MHz}$  |                   | -103 |     | dBc              | C                         |
|   | $f = 50\text{MHz}$  |                   | -91  |     | dBc              | C                         |
|   | $f = 100\text{MHz}$   |                   | -86  |     | dBc              | C                         |
|   | $f = 200\text{MHz}$   |                   | -77  |     | dBc              | C                         |
| Second-order intermodulation distortion | $f = 50\text{MHz}$ , 10MHz spacing                            |                   | -80  |     | dBc              | C                         |
|   | $f = 100\text{MHz}$ , 10MHz spacing                           |                   | -79  |     | dBc              | C                         |
|   | $f = 150\text{MHz}$ , 10MHz spacing                           |                   | -77  |     | dBc              | C                         |
|   | $f = 200\text{MHz}$ , 10MHz spacing                           |                   | -76  |     | dBc              | C                         |
| Third-order intermodulation distortion  | $f = 50\text{MHz}$ , 10MHz spacing                            |                   | -107 |     | dBc              | C                         |
|   | $f = 100\text{MHz}$ , 10MHz spacing                           |                   | -107 |     | dBc              | C                         |
|   | $f = 150\text{MHz}$ , 10MHz spacing                           |                   | -97  |     | dBc              | C                         |
|   | $f = 200\text{MHz}$ , 10MHz spacing                           |                   | -82  |     | dBc              | C                         |
| 1dB compression point                   | $f = 100\text{MHz}$   | $R_L = 20\Omega$  | 19.6 |     | dBm              | C                         |
|   |   | $R_L = 400\Omega$ | 8.7  |     | dBm              | C                         |

(1) Test levels: (A) 100% tested at  $+25^\circ\text{C}$ . Over-temperature limits by characterization and simulation. (B) Limits set by characterization and simulation. (C) Typical value only for information.

## ELECTRICAL CHARACTERISTICS (continued)

Test conditions are at  $T_A = +25^\circ\text{C}$ ,  $V_{S+} = +5\text{V}$ ,  $V_{OCM} = +2.5\text{V}$ ,  $V_{OUT} = 2V_{PP}$ ,  $R_L = 400\Omega$  differential,  $G = +6\text{dB}$ , differential input and output, and input and output referenced to midsupply, unless otherwise noted. Measured using evaluation module as discussed in [Test Circuits](#) section.

| PARAMETER                                      | TEST CONDITIONS   | MIN  | TYP      | MAX  | UNIT                         | TEST LEVEL <sup>(1)</sup> |   |
|--|---|--|----------|------|------------------------------|---------------------------|---|
| Output third-order intercept point             | At device outputs, $R_L = 400\Omega$ , $f = 100\text{MHz}$  |  | 48       |      | dBm                          | C                         |   |
| Input-referred voltage noise                   | $f > 100\text{kHz}$   |  | 1.7      |      | $\text{nV}/\sqrt{\text{Hz}}$ | C                         |   |
| Output-referred voltage noise                  | $f > 100\text{kHz}$   |  | 3.4      |      | $\text{nV}/\sqrt{\text{Hz}}$ | C                         |   |
| Noise figure                                   | 100 $\Omega$ differential source  | $f = 50\text{MHz}$                               |          | 10.5 |                              | dB                        | C |
|  |   | $f = 100\text{MHz}$                              |          | 11   |                              | dB                        | C |
|  |   | $f = 200\text{MHz}$                              |          | 13   |                              | dB                        | C |
| Overdrive recovery                             | Overdrive = $\pm 0.5\text{V}$   |  | 5        | 7.5  | ns                           | B                         |   |
| Output balance error                           | $f = 200\text{MHz}$   |  | -60      |      | dB                           | C                         |   |
| Output impedance                               | $f = 100\text{MHz}$   |  | 4.4      |      | $\Omega$                     | C                         |   |
| <b>DC PERFORMANCE</b>                          |   |  |          |      |                              |                           |   |
| Gain   | $T_A = +25^\circ\text{C}$ , $R_L = 400\Omega$   | 5.75   | 6        | 6.25 | dB                           | A                         |   |
|  | $T_A = +25^\circ\text{C}$ , $R_L = 100\Omega$   | 5.5  | 5.7      | 5.9  | dB                           | B                         |   |
|  | $T_A = -40^\circ\text{C}$ to $+85^\circ\text{C}$ , $R_L = 400\Omega$                                | 5.7  |          | 6.3  | dB                           | B                         |   |
|  | $T_A = -40^\circ\text{C}$ to $+85^\circ\text{C}$ , $R_L = 100\Omega$                                | 5.45   |          | 5.95 | dB                           | B                         |   |
| Output offset                                  | $T_A = +25^\circ\text{C}$   | -10  | $\pm 1$  | 10   | mV                           | A                         |   |
|  | $T_A = -40^\circ\text{C}$ to $+85^\circ\text{C}$  | -12.5  |          | 12.5 | mV                           | B                         |   |
| Common-mode rejection ratio                    | $T_A = +25^\circ\text{C}$   | 36   | 60       |      | dB                           | A                         |   |
|  | $T_A = -40^\circ\text{C}$ to $+85^\circ\text{C}$  | 35   |          |      | dB                           | B                         |   |
| <b>INPUT</b>                                   |   |  |          |      |                              |                           |   |
| Differential input resistance                  |   | 85   | 100      | 115  | $\Omega$                     | A                         |   |
| Input common-mode range                        | Inputs shorted together, $V_{OCM} = 2.5\text{V}$  | 2.25   |          | 2.75 | V                            | A                         |   |
|  | $V_{OCM} = 2.5\text{V}$ , $V_{OUT} = 3V_{PP}$ , HD degradation < 3dB, see <a href="#">Figure 13</a> | 1.5  |          | 3.1  | V                            | C                         |   |
| <b>OUTPUT</b>                                  |   |  |          |      |                              |                           |   |
| Most positive output voltage                   | Each output with 200 $\Omega$ to midsupply  | $T_A = +25^\circ\text{C}$                        | 3.64     | 3.7  |                              | V                         | A |
|  |   | $T_A = -40^\circ\text{C}$ to $+85^\circ\text{C}$ | 3.59     |      |                              | V                         | B |
| Least positive output voltage                  | Each output with 200 $\Omega$ to midsupply  | $T_A = +25^\circ\text{C}$                        |          | 1.3  | 1.4                          | V                         | A |
|  |   | $T_A = -40^\circ\text{C}$ to $+85^\circ\text{C}$ |          |      | 1.45                         | V                         | B |
| Most positive output voltage                   | Each output with 50 $\Omega$ to midsupply   | $T_A = +25^\circ\text{C}$                        | 3.59     | 3.6  |                              | V                         | A |
|  |   | $T_A = -40^\circ\text{C}$ to $+85^\circ\text{C}$ | 3.54     |      |                              | V                         | B |
| Least positive output voltage                  | Each output with 50 $\Omega$ to midsupply   | $T_A = +25^\circ\text{C}$                        |          | 1.3  | 1.5                          | V                         | A |
|  |   | $T_A = -40^\circ\text{C}$ to $+85^\circ\text{C}$ |          |      | 1.55                         | V                         | B |
| Differential output voltage                    | $T_A = +25^\circ\text{C}$ , $R_L = 400\Omega$   | 4.4  | 4.85     |      | $V_{PP}$                     | B                         |   |
|  | $T_A = -40^\circ\text{C}$ to $+85^\circ\text{C}$ , $R_L = 400\Omega$                                | 4.2  |          |      | $V_{PP}$                     | B                         |   |
| Differential output current drive              | $T_A = +25^\circ\text{C}$ , $R_L = 10\Omega$  |  | 80       |      | mA                           | B                         |   |
|  | $T_A = -40^\circ\text{C}$ to $+85^\circ\text{C}$ , $R_L = 10\Omega$                                 |  | 80       |      | mA                           | B                         |   |
| <b>OUTPUT COMMON-MODE VOLTAGE CONTROL</b>      |   |  |          |      |                              |                           |   |
| $V_{OCM}$ small-signal bandwidth               | $V_{OUT,CM} = 200\text{mV}_{PP}$  |  | 525      |      | MHz                          | C                         |   |
| $V_{OCM}$ slew rate                            | $V_{OUT,CM} = 500\text{mV}_{PP}$  |  | 180      |      | $\text{V}/\mu\text{s}$       | C                         |   |
| $V_{OCM}$ voltage range                        | Supplied by external source <sup>(2)</sup>  | 2.25   | 2.5      | 2.75 | V                            | C                         |   |
| $V_{OCM}$ gain                                 | $V_{OCM} = 2.5\text{V}$   | 0.98   | 1        | 1.02 | V/V                          | A                         |   |
| Output common-mode offset from $V_{OCM}$ input | $V_{OCM} = 2.5\text{V}$   | -30  | 12       | 30   | mV                           | A                         |   |
| $V_{OCM}$ input bias current                   | $2.25\text{V} \leq V_{OCM} \leq 2.75\text{V}$   | -400   | $\pm 30$ | 400  | $\mu\text{A}$                | A                         |   |

(2) Limits set by best harmonic distortion with  $V_{OUT} = 3V_{PP}$ .  $V_{OCM}$  voltage range can be extended if lower output swing is used or distortion degradation is allowed, and increased bias current into pin is acceptable. For more information, see [Figure 12](#) and [Figure 31](#).

## ELECTRICAL CHARACTERISTICS (continued)

Test conditions are at  $T_A = +25^\circ\text{C}$ ,  $V_{S+} = +5\text{V}$ ,  $V_{OCM} = +2.5\text{V}$ ,  $V_{OUT} = 2V_{PP}$ ,  $R_L = 400\Omega$  differential,  $G = +6\text{dB}$ , differential input and output, and input and output referenced to midsupply, unless otherwise noted. Measured using evaluation module as discussed in [Test Circuits](#) section.

| PARAMETER  | TEST CONDITIONS   | MIN  | TYP  | MAX  | UNIT                      | TEST LEVEL <sup>(1)</sup> |
|--|---|------|------|------|---------------------------|---------------------------|
| <b>POWER SUPPLY</b>                              |   |      |      |      |                           |                           |
| Specified operating voltage                      |   | 4.75 | 5    | 5.25 | V                         | C                         |
| Quiescent current                                | $T_A = +25^\circ\text{C}$   | 85   | 100  | 115  | mA                        | A                         |
|  | $T_A = -40^\circ\text{C}$ to $+85^\circ\text{C}$                            | 80   |      | 125  | mA                        | B                         |
| Power-supply rejection ratio                     | $T_A = +25^\circ\text{C}$ , $V_{CC} \pm 0.25\text{V}$                       | 60   | 90   |      | dB                        | A                         |
|  | $T_A = -40^\circ\text{C}$ to $+85^\circ\text{C}$ , $V_{CC} \pm 0.5\text{V}$ | 59   |      |      | dB                        | B                         |
| <b>POWER-DOWN</b>                                |   |      |      |      |                           |                           |
| Enable voltage threshold                         | Device powers on below 0.5V   |      |      | 0.5  | V                         | A                         |
| Disable voltage threshold                        | Device powers down above 2.0V   | 2    |      |      | V                         | A                         |
| Power-down quiescent current                     |   |      | 0.8  | 3    | mA                        | A                         |
| Input bias current                               |   |      | 80   | 100  | $\mu\text{A}$             | A                         |
| Turn-on time delay                               | Time to $V_{OUT} = 90\%$ of final value                                     |      | 10   |      | $\mu\text{s}$             | C                         |
| Turn-off time delay                              | Time to $V_{OUT} = 10\%$ of original value                                  |      | 0.15 |      | $\mu\text{s}$             | C                         |
| <b>THERMAL CHARACTERISTICS</b>                   |   |      |      |      |                           |                           |
| Specified operating range                        |   | -40  |      | +85  | $^\circ\text{C}$          | C                         |
| Thermal resistance, $\theta_{JC}$ <sup>(3)</sup> | Junction to case (bottom)   |      | 8.9  |      | $^\circ\text{C}/\text{W}$ | C                         |
| Thermal resistance, $\theta_{JA}$ <sup>(3)</sup> | Junction to ambient   |      | 44.1 |      | $^\circ\text{C}/\text{W}$ | C                         |

- (3) Tested using JEDEC High-K test PCB. Thermal management of the final printed circuit board (PCB) should keep the junction temperature below  $+125^\circ\text{C}$  for long term reliability.

### PIN CONFIGURATION

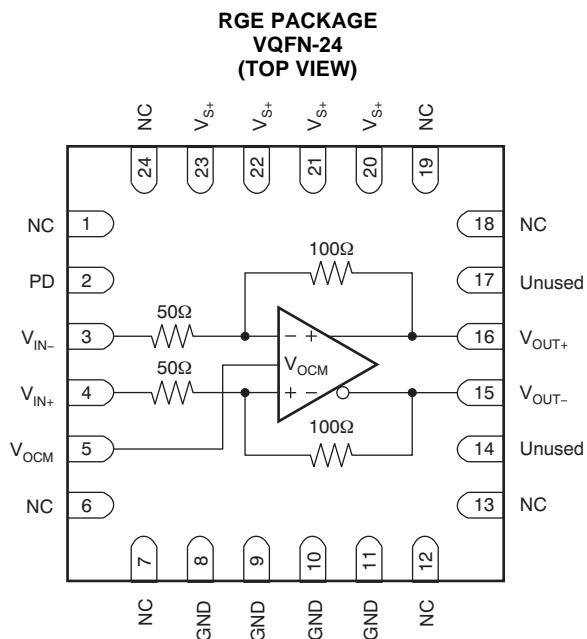

### PIN DESCRIPTIONS

| PIN            |                   | DESCRIPTION  |
|----------------|-------------------|--|
| NO.            | NAME              |  |
| 1              | NC                | No internal connection   |
| 2              | PD                | Power down. High = low power (sleep) mode. Low = active.                             |
| 3              | V <sub>IN-</sub>  | Inverting input pin  |
| 4              | V <sub>IN+</sub>  | Noninverting input pin   |
| 5              | V <sub>OCM</sub>  | Output common-mode voltage control input pin   |
| 6, 7           | NC                | No internal connection   |
| 8, 9, 10, 11   | GND               | Ground. Must be connected to thermal pad.  |
| 12, 13         | NC                | No internal connection   |
| 14             | Unused            | Bonded to die, but not used. Tie to GND.   |
| 15             | V <sub>OUT-</sub> | Inverting output pin   |
| 16             | V <sub>OUT+</sub> | Noninverting output pin  |
| 17             | Unused            | Bonded to die, but not used. Tie to GND.   |
| 18, 19         | NC                | No internal connection   |
| 20, 21, 22, 23 | V <sub>S+</sub>   | Power supply pins, +5V nominal   |
| 24             | NC                | No internal connection   |
| Thermal pad    |                   | Thermal pad on bottom of device is used for heat dissipation and must be tied to GND |

## TYPICAL CHARACTERISTICS

### TABLE OF GRAPHS

| TITLE  | FIGURE                    |
|--|---------------------------|
| Frequency Response Magnitude (with Transformers)                                       | <a href="#">Figure 1</a>  |
| Frequency Response Magnitude (no Transformers)   | <a href="#">Figure 2</a>  |
| Frequency Response Phase (no Transformers)   | <a href="#">Figure 3</a>  |
| Small- and Large-Signal Pulse Response   | <a href="#">Figure 4</a>  |
| Slew Rate vs Output Voltage Step   | <a href="#">Figure 5</a>  |
| Overdrive Recovery   | <a href="#">Figure 6</a>  |
| Single-Ended Input Harmonic Distortion vs Frequency                                    | <a href="#">Figure 7</a>  |
| Harmonic Distortion vs Frequency   | <a href="#">Figure 8</a>  |
| Harmonic Distortion vs Frequency, $V_{OUT} = 0.9V_{PP}$                                | <a href="#">Figure 9</a>  |
| Harmonic Distortion vs $V_{OUT}$   | <a href="#">Figure 10</a> |
| Harmonic Distortion vs $R_L$   | <a href="#">Figure 11</a> |
| Harmonic Distortion vs $V_{OCM}$   | <a href="#">Figure 12</a> |
| Intermodulation Distortion vs Frequency, $V_{OUT} = 2V_{PP}, 3V_{PP}$ Envelope         | <a href="#">Figure 14</a> |
| Intermodulation Distortion vs Frequency, $V_{OUT} = 0.9V_{PP}$ Envelope                | <a href="#">Figure 15</a> |
| Output Intercept Point vs Frequency  | <a href="#">Figure 16</a> |
| Maximum Differential Output Voltage Swing Peak-to-Peak vs Differential Load Resistance | <a href="#">Figure 17</a> |
| Maximum/Minimum Single-Ended Output Voltage vs Differential Load Resistance            | <a href="#">Figure 18</a> |
| Differential Output Impedance vs Frequency   | <a href="#">Figure 19</a> |
| s-Parameters (Magnitude)   | <a href="#">Figure 20</a> |
| Frequency Response vs Capacitive Load  | <a href="#">Figure 21</a> |
| Recommended $R_O$ vs Capacitive Load   | <a href="#">Figure 22</a> |
| Common-Mode Rejection Ratio vs Frequency   | <a href="#">Figure 23</a> |
| Power-Supply Rejection Ratio vs Frequency  | <a href="#">Figure 24</a> |
| $V_{OCM}$ Pulse Response   | <a href="#">Figure 25</a> |
| Turn-On Time   | <a href="#">Figure 26</a> |
| Turn-Off Time  | <a href="#">Figure 27</a> |
| Input and Output Voltage Noise vs Frequency  | <a href="#">Figure 28</a> |
| Output Balance Error vs Frequency  | <a href="#">Figure 29</a> |
| $V_{OCM}$ Small-Signal Frequency Response  | <a href="#">Figure 30</a> |
| $V_{OCM}$ Input Bias Current vs $V_{OCM}$ Input Voltage                                | <a href="#">Figure 31</a> |
| Noise Figure vs Frequency  | <a href="#">Figure 32</a> |

### TYPICAL CHARACTERISTICS

At  $T_A = +25^\circ\text{C}$ ,  $V_{S+} = +5\text{V}$ ,  $V_{OCM} = +2.5\text{V}$ ,  $V_{OUT} = 2V_{PP}$ ,  $R_L = 400\Omega$  differential,  $G = +6\text{dB}$ , differential input and output, and input and output pins referenced to midsupply, unless otherwise noted. Measured using EVM as discussed in [Test Circuits](#) section.

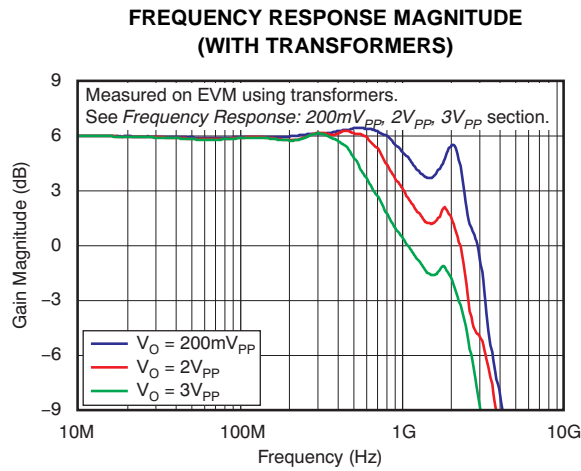

Figure 1.

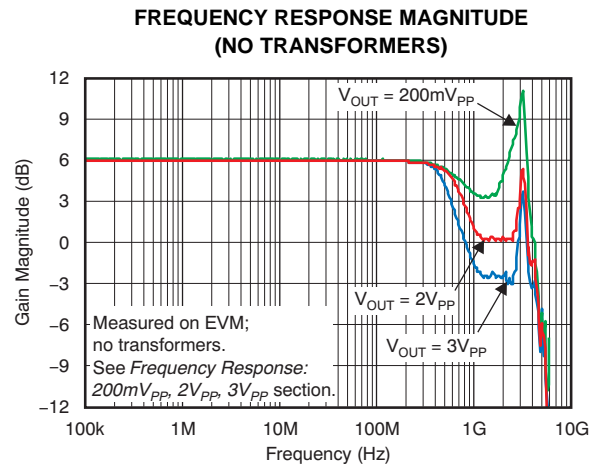

Figure 2.

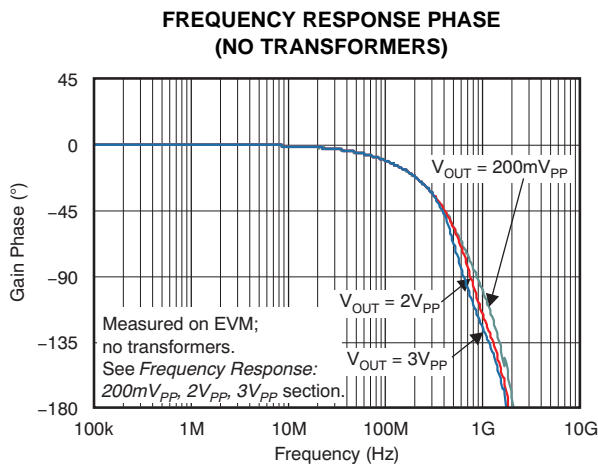

Figure 3.

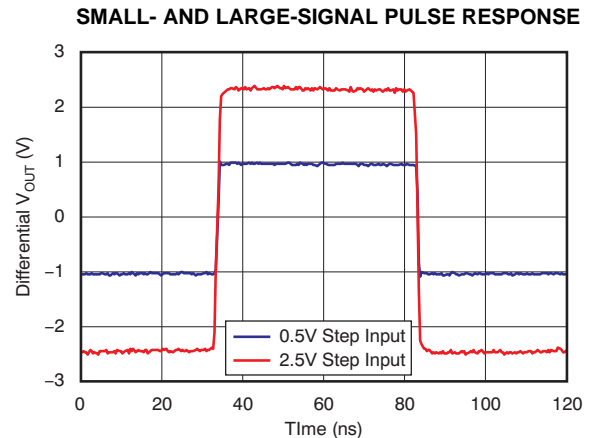

Figure 4.

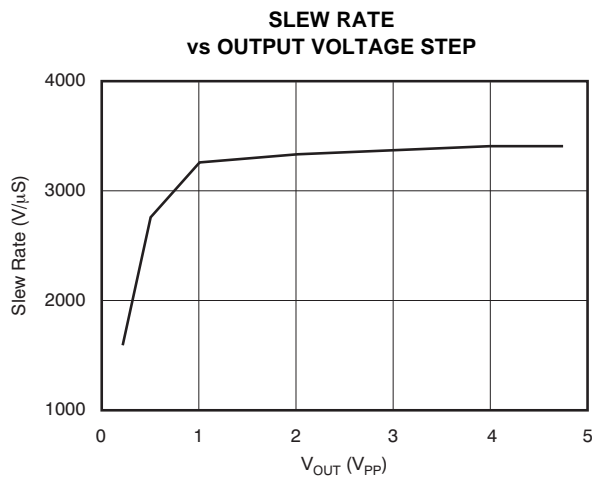

Figure 5.

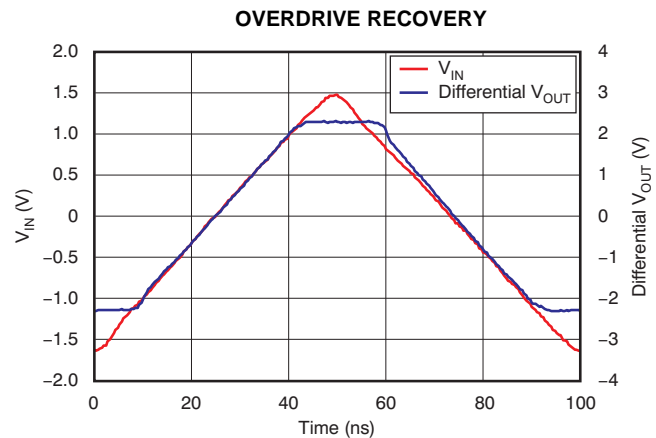
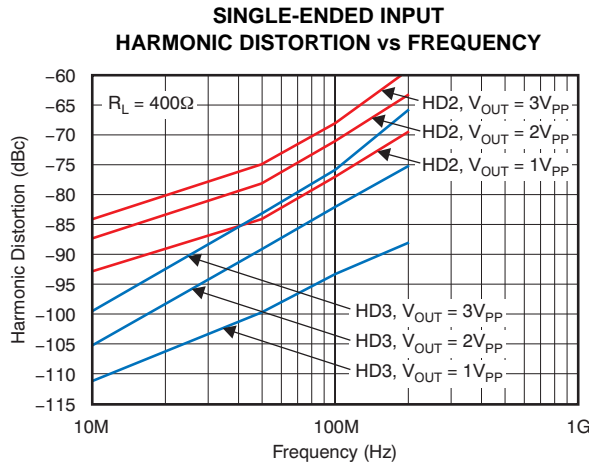

Figure 6.



**TYPICAL CHARACTERISTICS (continued)**

At  $T_A = +25^\circ\text{C}$ ,  $V_{S+} = +5\text{V}$ ,  $V_{OCM} = +2.5\text{V}$ ,  $V_{OUT} = 2V_{PP}$ ,  $R_L = 400\Omega$  differential,  $G = +6\text{dB}$ , differential input and output, and input and output pins referenced to midsupply, unless otherwise noted. Measured using EVM as discussed in [Test Circuits](#) section.



**Figure 7.**

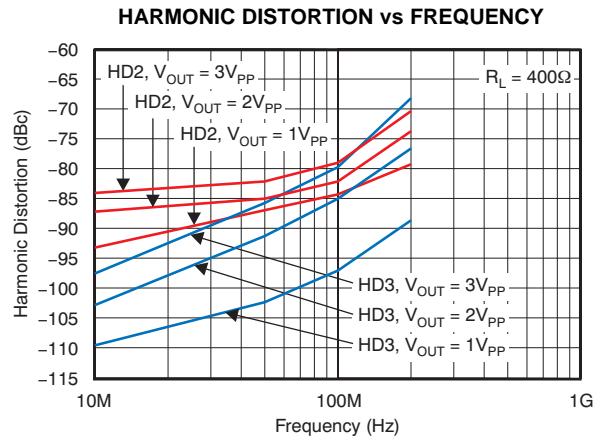

**Figure 8.**

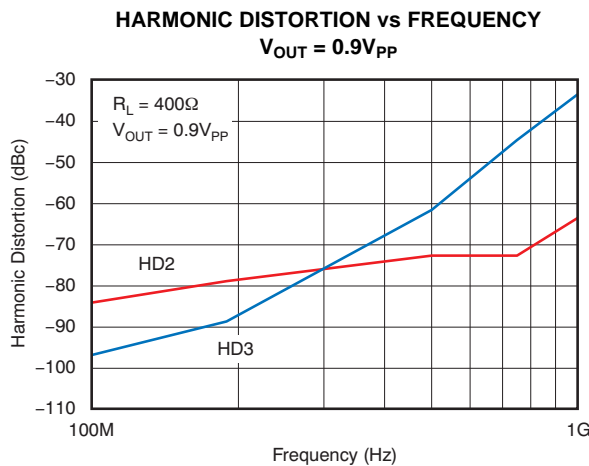

**Figure 9.**

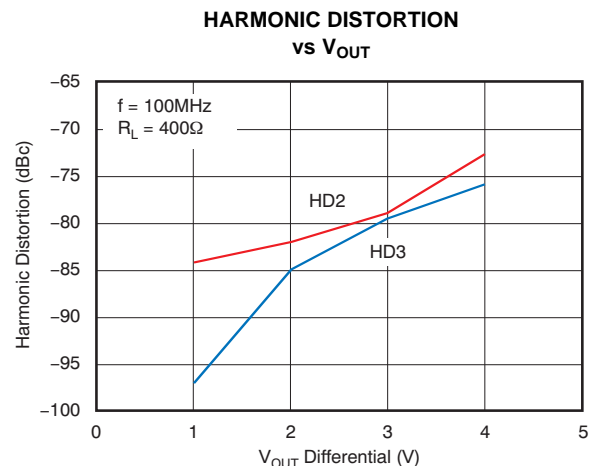

**Figure 10.**

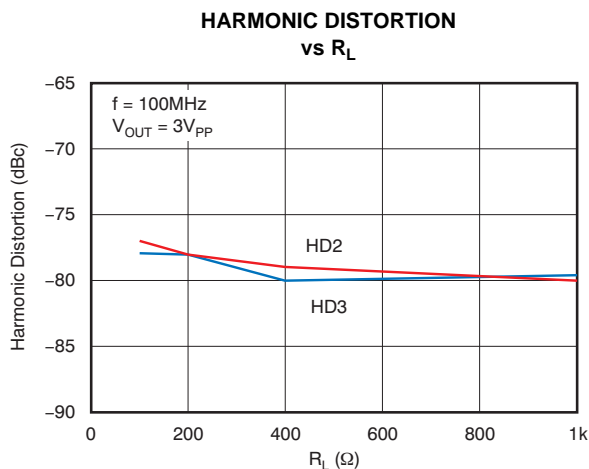

**Figure 11.**

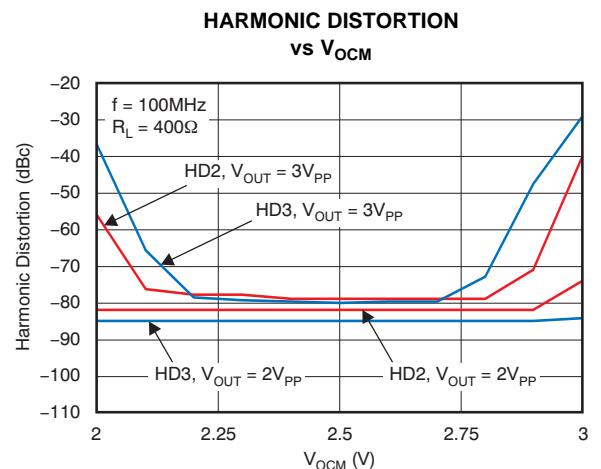

**Figure 12.**

**TYPICAL CHARACTERISTICS (continued)**

At  $T_A = +25^\circ\text{C}$ ,  $V_{S+} = +5\text{V}$ ,  $V_{OCM} = +2.5\text{V}$ ,  $V_{OUT} = 2\text{V}_{PP}$ ,  $R_L = 400\Omega$  differential,  $G = +6\text{dB}$ , differential input and output, and input and output pins referenced to midsupply, unless otherwise noted. Measured using EVM as discussed in [Test Circuits](#) section.

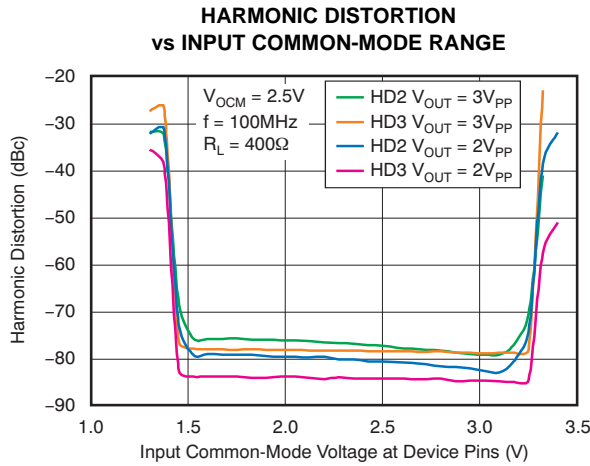

Figure 13.

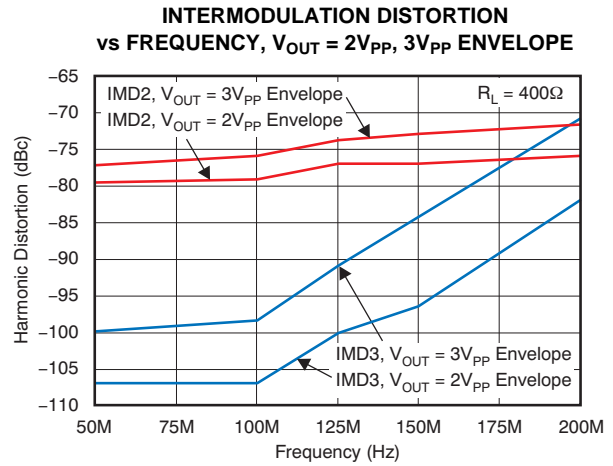

Figure 14.

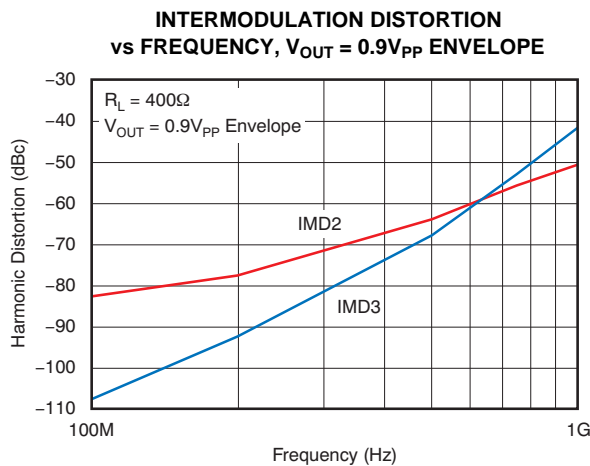

Figure 15.

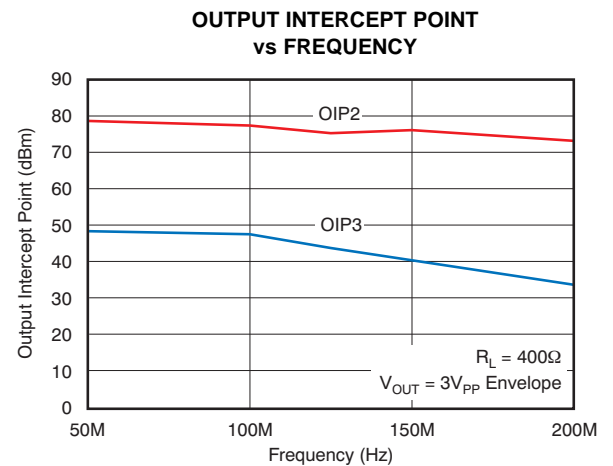

Figure 16.

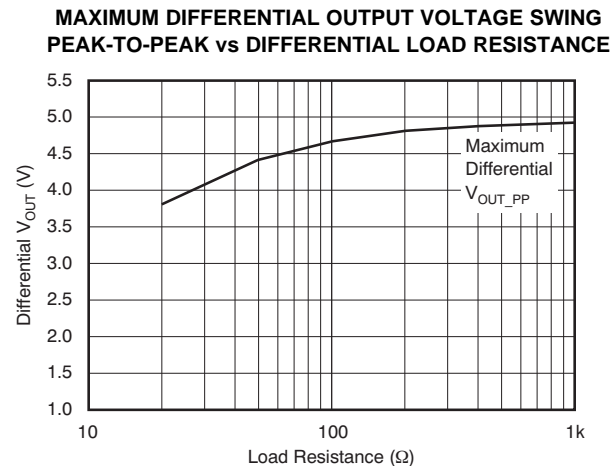

Figure 17.

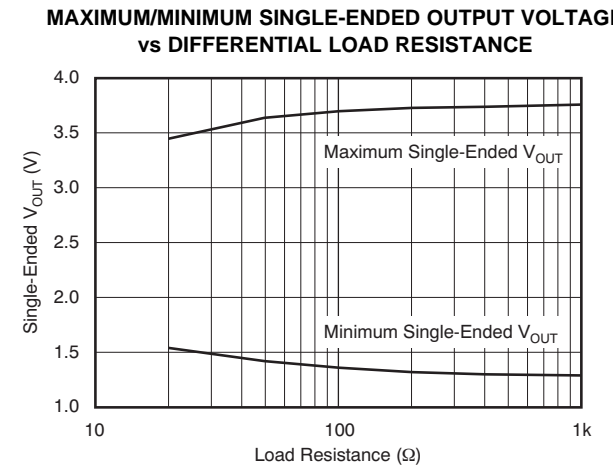
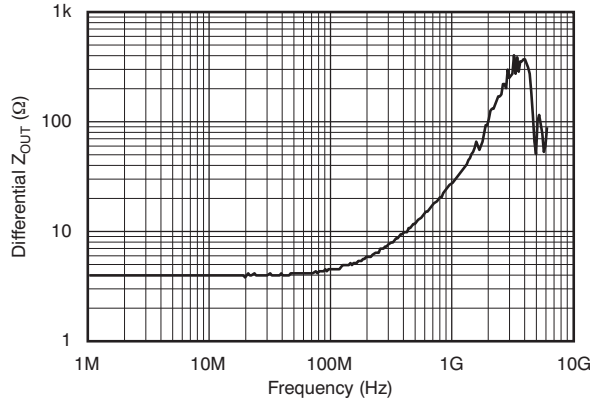

Figure 18.

**TYPICAL CHARACTERISTICS (continued)**

At  $T_A = +25^\circ\text{C}$ ,  $V_{S+} = +5\text{V}$ ,  $V_{OCM} = +2.5\text{V}$ ,  $V_{OUT} = 2\text{V}_{PP}$ ,  $R_L = 400\Omega$  differential,  $G = +6\text{dB}$ , differential input and output, and input and output pins referenced to midsupply, unless otherwise noted. Measured using EVM as discussed in [Test Circuits](#) section.

**DIFFERENTIAL OUTPUT IMPEDANCE vs FREQUENCY**



**Figure 19.**

**s-PARAMETERS (MAGNITUDE)**

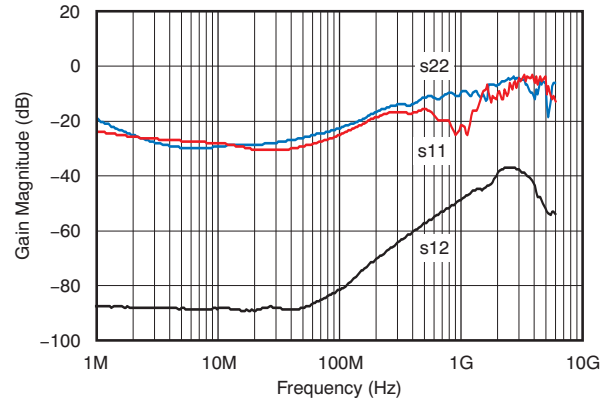

**Figure 20.**

**FREQUENCY RESPONSE vs CAPACITIVE LOAD**

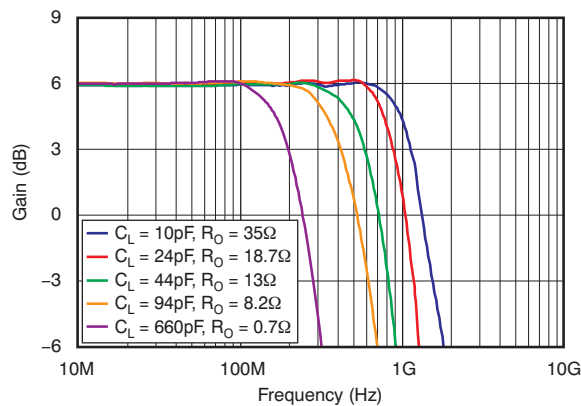

**Figure 21.**

**RECOMMENDED  $R_O$  vs CAPACITIVE LOAD**

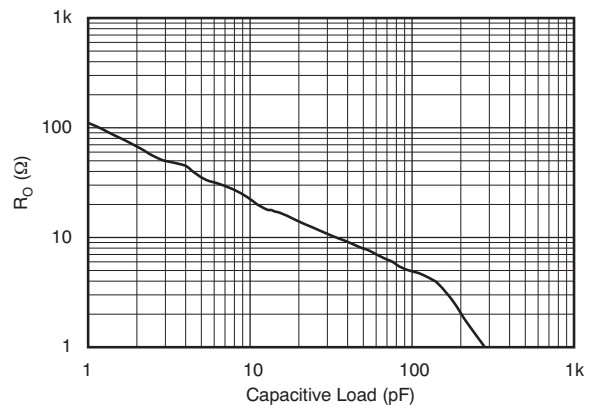

**Figure 22.**

**COMMON-MODE REJECTION RATIO vs FREQUENCY**

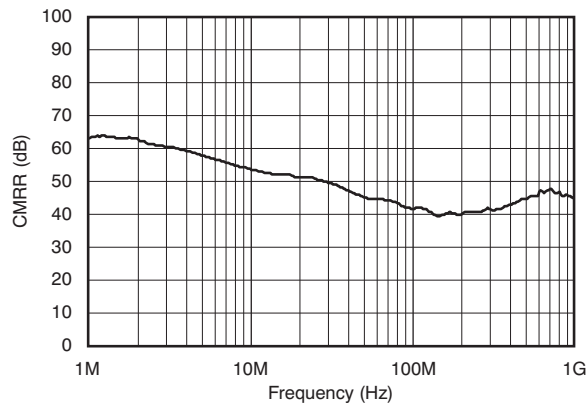

**Figure 23.**

**POWER-SUPPLY REJECTION RATIO vs FREQUENCY**

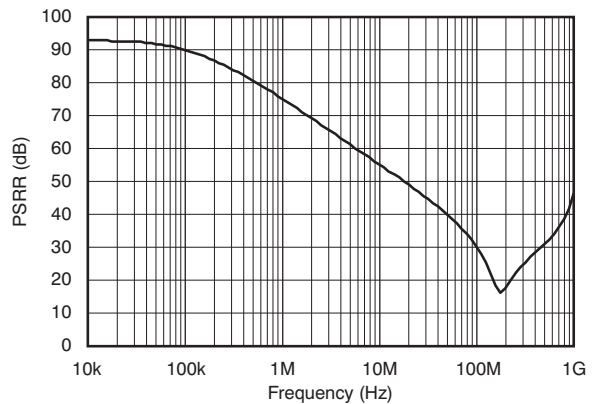

**Figure 24.**

**TYPICAL CHARACTERISTICS (continued)**

At  $T_A = +25^\circ\text{C}$ ,  $V_{S+} = +5\text{V}$ ,  $V_{OCM} = +2.5\text{V}$ ,  $V_{OUT} = 2V_{PP}$ ,  $R_L = 400\Omega$  differential,  $G = +6\text{dB}$ , differential input and output, and input and output pins referenced to midsupply, unless otherwise noted. Measured using EVM as discussed in [Test Circuits](#) section.

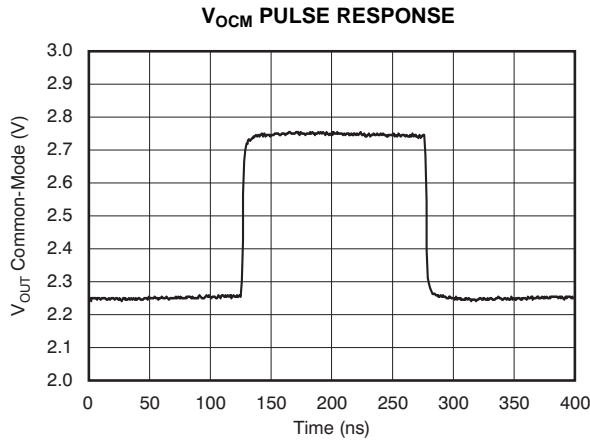

Figure 25.

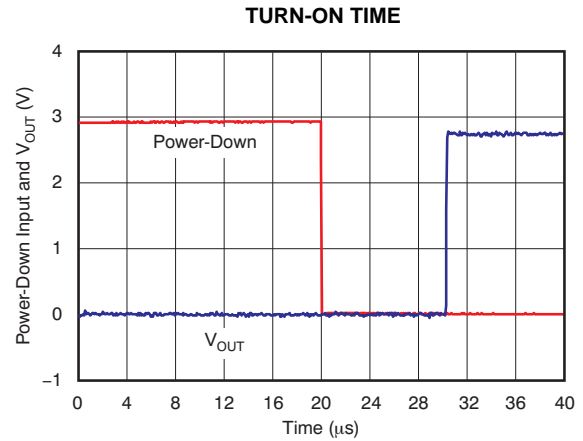

Figure 26.

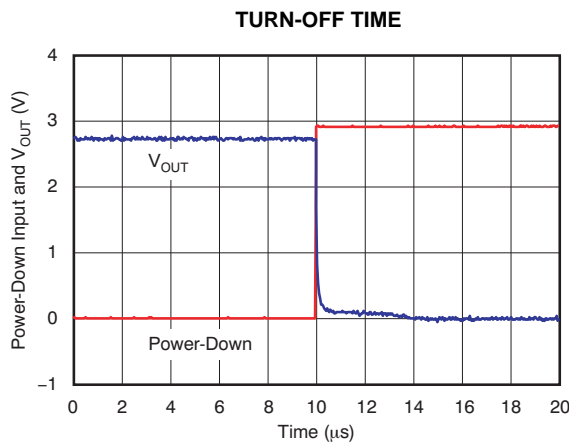

Figure 27.

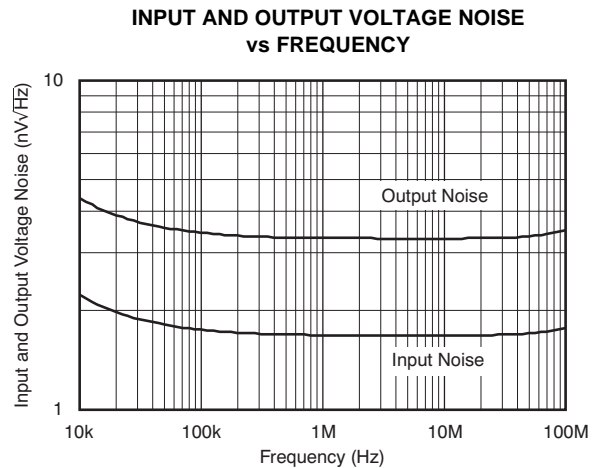

Figure 28.

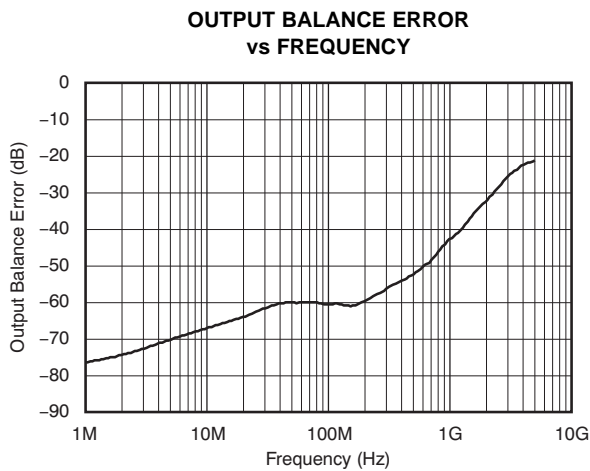

Figure 29.

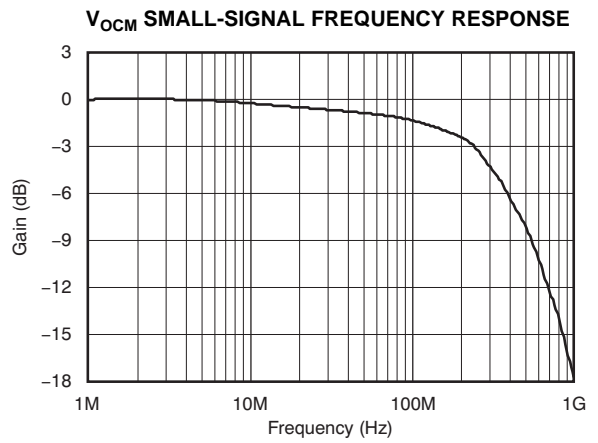
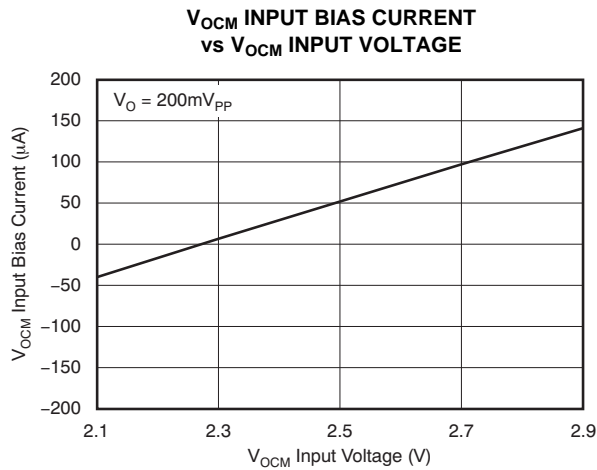

Figure 30.

**TYPICAL CHARACTERISTICS (continued)**

At  $T_A = +25^\circ\text{C}$ ,  $V_{S+} = +5\text{V}$ ,  $V_{\text{OCM}} = +2.5\text{V}$ ,  $V_{\text{OUT}} = 2V_{\text{PP}}$ ,  $R_L = 400\Omega$  differential,  $G = +6\text{dB}$ , differential input and output, and input and output pins referenced to midsupply, unless otherwise noted. Measured using EVM as discussed in [Test Circuits](#) section.



**Figure 31.**

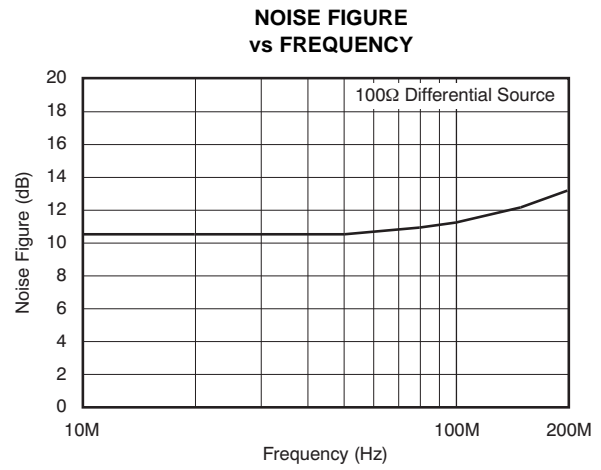

**Figure 32.**

## TEST CIRCUITS

### OVERVIEW

The standard THS770006 evaluation module (EVM) is used for testing the typical performance shown in the Typical Characteristics, with changes as noted below. The EVM schematic is shown in [Figure 33](#). The signal generators and analyzers used for most tests have single-ended 50Ω input and output impedance. The THS770006 EVM is configured to convert to and from a differential 50Ω impedance by using RF transformers or baluns (CX2156NL from Pulse, supplied as a standard configuration of the EVM). For line input termination, two 49.9Ω resistors (R5 and R6) are placed to ground on the input transformer output pins (terminals 1 and 3). In combination with the 100Ω input impedance of the device, the total impedance seen by the line is 50Ω.

A resistor network is used on the amplifier output to present various loads ( $R_L$ ) and maintain line output termination to 50Ω. Depending on the test conditions, component values are changed as shown in [Table 1](#), or as otherwise noted. As a result of the voltage divider on the output formed by the load component values, the amplifier output is attenuated. The *Loss* column in [Table 1](#) shows the attenuation expected from the resistor divider. The output transformer causes slightly more loss, so these numbers are approximate.

**Table 1. Load Component Values<sup>(1)</sup>**

| LOAD $R_L$ | R15 AND R17 | R16   | LOSS   |
|------------|-------------|-------|--------|
| 100Ω       | 25Ω         | Open  | 6dB    |
| 200Ω       | 86.6Ω       | 69.8Ω | 16.8dB |
| 400Ω       | 187Ω        | 57.6Ω | 25.5dB |
| 1kΩ        | 487Ω        | 52.3Ω | 31.8dB |

(1) The total load includes 50Ω termination by the test equipment. Components are chosen to achieve load and 50Ω line termination through a 1:1 transformer.

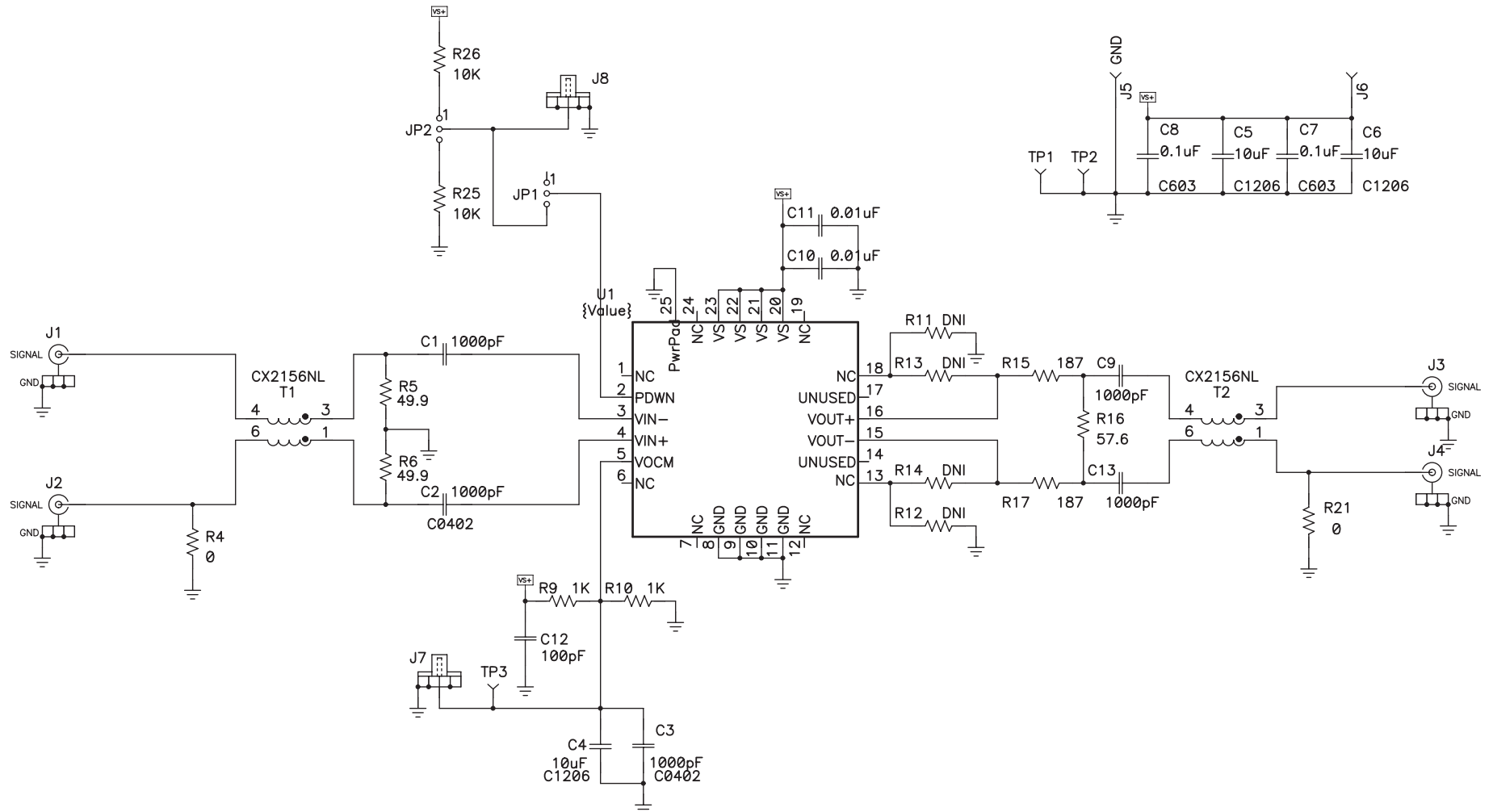

Figure 33. THS770006IRGE EVM Schematic

## TEST DESCRIPTIONS

The following sections describe how the tests were performed, as well as the EVM circuit modifications that were made (if any). Modifications made for test purposes include changing capacitors to resistors, resistors to capacitors, the shorting/opening of components, etc., as noted. Unless otherwise noted, C1, C2, C9, and C13 are all changed to 0.1 $\mu$ F.

### Frequency Response: 200mV<sub>PP</sub>, 2V<sub>PP</sub>, 3V<sub>PP</sub>

This test is run with and without transformers in the signal path.

For tests with transformers, the standard EVM is used and only the gain magnitude is shown. A network analyzer is connected to the input and output of the EVM with 50 $\Omega$  coaxial cables and set to measure the forward transfer function (s21). The input signal frequency is swept with the signal level set for the desired output amplitude. The use of transformers gives better magnitude response that correlates best with detailed design simulation in terms of peaking in the response due to better control of parasitic capacitance at the device output pins, but also results in excess phase shift. So only magnitude is plotted.

For tests without transformers, the standard EVM is used, with the gain magnitude and phase shown. A network analyzer is connected to the input of the EVM with 50 $\Omega$  coaxial cable, the output is terminated with a 50 $\Omega$  load, and a high impedance differential probe is used for the measurement. The analyzer is set to measure the forward transfer function (s21). The analyzer with a probe input is calibrated at the input pins of the device and signal is measured at the output pin, thus effectively removing the transformers from the transfer function. The input signal frequency is swept with signal level set for desired output amplitude. Not using transformers gives better phase response that correlates best with detailed design simulations, but as a result of extra parasitic capacitance at the device output pins gives significantly more peaking in the magnitude response. The –3dB points of the magnitude response measured without transformers correlates better with measured slew rate, so both magnitude and phase are plotted.

### s-Parameters: s11, s22, and s12

The standard EVM is used with both R15 and R17 = 24.9 $\Omega$ , and R16 = open, to test the input return loss, output return loss, and reverse isolation. A network analyzer is connected to the input and output of the EVM with 50 $\Omega$  coaxial cables and set to measure the appropriate transfer function: s11, s22, or s12. Note the transformers are included in the signal chain in order to retrieve proper measurements with single-ended test equipment. The impact is minimal from 10MHz to 200MHz, but further analysis is required to fully de-embed the respective effects.

### Frequency Response with Capacitive Load

The standard EVM is used with R15 and R17 = R<sub>O</sub>, R16 = C<sub>LOAD</sub>, C9 and C13 = 953 $\Omega$ , R21 = open, T2 removed, and jumpers placed across terminals 3 to 4 and 1 to 6. A network analyzer is connected to the input and output of the EVM with 50 $\Omega$  coaxial cables and set to measure the forward transfer function (s21). Different values of load capacitance are placed on the output (at R16) and the output resistor values (R15 and R17) changed until an optimally flat frequency response is achieved with maximum bandwidth.

### Distortion

The standard EVM is used for measurement of single-tone harmonic distortion and two-tone intermodulation distortion. For differential distortion measurements, the standard EVM is used with no modification. For single-ended input distortion measurements, the standard EVM is used with with T1 removed and jumpers placed across terminals 3 to 4 and 1 to 6, and R5 and R6 = 100 $\Omega$ . A signal generator is connected to the J1 input of the EVM with 50 $\Omega$  coaxial cables, with filters inserted inline to reduce distortion from the generator. The J3 output of the EVM is connected with 50 $\Omega$  coaxial cables to a spectrum analyzer to measure the fundamental(s) and distortion products.

### Noise Figure

The standard EVM is used with T1 changed to a 1:2 impedance ratio transformer (Mini-Circuits ADT2), R15 and R17 = 24.9 $\Omega$ , and R5, R6, and R16 = open. A noise figure analyzer is connected to the input and output of the EVM with 50 $\Omega$  coaxial cables. The noise figure analyzer provides a 50 $\Omega$  (noise) source so that the data are adjusted to refer to a 100 $\Omega$  source.



### Transient Response, Slew Rate, Overdrive Recovery

The standard EVM is used with T1 and T2 removed and jumpers placed across terminals 3 to 4 and 1 to 6; R15, R17, and R25 = 49.9Ω; C1, C2, C9, and C13 = 0Ω; and R5, R6, R16, and R21 = open. A differential waveform generator is connected to the input of the EVM with 50Ω coaxial cables at J1 and J2. The differential output at J3 and J4 is connected with 50Ω coaxial cables to an oscilloscope to measure the outputs. Waveform math in the oscilloscope is used to combine the differential output of the device.

### Power-Down

The standard EVM is used with T1 and T2 removed, jumpers placed across terminals 3 to 4 and 1 to 6, R15 and R17 = 49.9Ω, C9 and C13 = 0Ω, and R5, R6, R16, and R21 = open. A waveform generator is connected to the power-down input of the EVM with a 50Ω coaxial cable at J8. The differential output at J3 and J4 is connected with 50Ω coaxial cables to an oscilloscope to measure the outputs. J1 is left disconnected so that the output is driven to the  $V_{OCM}$  voltage when the device is active, and discharged through the resistive load on the output when disabled. Both outputs are the same and only one is shown.

### Differential Z-out

The standard EVM is used with R15 and R17 = 24.9Ω, and R16 = open. A network analyzer is connected to the output of the EVM at J3 with 50Ω coaxial cable, both inputs are terminated with a 50Ω load, and a high-impedance differential probe is used for the measurement. The analyzer is set to measure the forward transfer function (s21). The analyzer with probe input is calibrated across the open resistor pads of R16 and the signal is measured at the output pins of the device. The output impedance is calculated using the known resistor values and the attenuation caused by R15 and R17.

### Output Balance Error

The standard EVM is used with R15 and R17 = 100Ω, and R16 = 0Ω. A network analyzer is connected to the input of the EVM with 50Ω coaxial cable, the output is left open, and a high-impedance differential probe is used for the measurement. The analyzer is set to measure the forward transfer function (s21). The analyzer with probe input is calibrated at the input pins of the device and the signal is measured from the shorted pads of R16 to ground.

### Common-Mode Rejection

The standard EVM is used with T1 removed and jumpers place across terminals 3 to 4, 1 to 6, and 1 to 3. A network analyzer is connected to the input and output of the EVM with 50Ω coaxial cable and set to measure the forward transfer function (s21).

### $V_{OCM}$ Frequency Response

The standard EVM is used with T2 removed and jumpers across terminals 3 to 4 and 1 to 6; R10, R15, and R17 = 49.9Ω; C3 and C4 = 0Ω; and R9, R16, and R21 = open. A network analyzer is connected to the  $V_{OCM}$  input of the EVM at J7 and output of the EVM with 50Ω coaxial cable, and set to measure the forward transfer function (s21). The input signal frequency is swept with the signal level set for 200mV. Each output at J3 and J4 is measured as single-ended, and because both are the same, only one output is shown.

### $V_{OCM}$ Slew Rate and Pulse Response

The standard EVM is used with T2 removed and jumpers across terminals 3 to 4 and 1 to 6; R10, R15, and R17 = 49.9Ω; C9 and C13 = 0Ω; and C3, C4, R9, R16, and R21 = open. A waveform generator is connected to the  $V_{OCM}$  input of the EVM at J7 with 50Ω coaxial cable. The differential output at J3 and J4 is connected with 50Ω coaxial cable to an oscilloscope to measure the outputs. J1 is left disconnected so that the output is driven to the  $V_{OCM}$  voltage. Both outputs are the same, so only one is shown.

### Input/Output Voltage Noise, Settling Time, and Power-Supply Rejection

These parameters are taken from simulation.

## THEORY OF OPERATION

### GENERAL DESCRIPTION

The THS770006 is a fixed-gain of +6dB, wideband, fully-differential amplifier designed and optimized specifically for driving 14-bit and 16-bit ADCs at input frequencies up to 200MHz. This device provides high bandwidth, low distortion, and low noise, which are critical parameters in high-speed data acquisition systems that require very high dynamic range, such as wireless base stations and test and measurement applications. It also makes an excellent differential amplifier for general-purpose, high-speed differential signal chain and short line-driver applications. The device has an operating power-supply range of 4.75V to 5.5V. The THS770006 has proprietary circuitry to provide very fast recovery from overdrive conditions and has a power-down mode for power saving. The THS770006 is offered in a Pb-free (RoHS compliant) and green, QFN-24 thermally-enhanced package. It is characterized for operation over the industrial temperature range of  $-40^{\circ}\text{C}$  to  $+85^{\circ}\text{C}$ .

The amplifier uses two negative-feedback loops. One is for the primary differential amplifier and the other controls the common-mode operation.

### Primary Differential Amplifier

The primary amplifier of the THS770006 is a fully-differential op amp with on-chip gain setting resistors ( $R_F = 100\Omega$  and  $R_G = 50\Omega$ ) that fix the differential gain at  $2V/V$ , or 6dB, by use of negative feedback.

### $V_{\text{OCM}}$ Control Loop

The output common-mode voltage is controlled through a second negative-feedback loop. The output common-mode voltage is internally sensed and compared to the  $V_{\text{OCM}}$  pin. The loop then works to drive the difference, or error voltage, to zero in order to maintain the output common-mode voltage =  $V_{\text{OCM}}$  (within the loop gain and bandwidth of the loop). For more details on fully-differential amplifier theory and use, see application report [SLOA054](#), *Fully-Differential Amplifiers*, available for download from [www.ti.com](#).

## OPERATION

### Differential to Differential

The THS770006 is a fixed gain of 6dB, fully-differential amplifier that can be used to amplify differential input signals to differential output signals. A basic block diagram of the circuit is shown in [Figure 34](#). The differential input to differential output configuration gives the best performance; the signal source and load should be balanced.

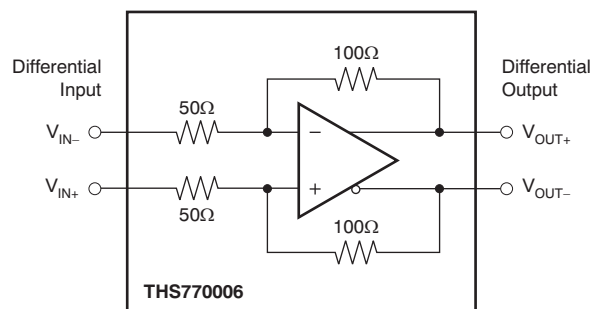

**Figure 34. Differential Input to Differential Output Amplifier**

## Single-Ended to Differential

The THS770006 can be used to amplify and convert single-ended input signals to differential output signals. A basic block diagram of the circuit is shown in [Figure 35](#). The gain from the single-ended input to the differential output is 6dB. In order to maintain proper balance in the amplifier and avoid offsets at the output, the alternate input must be biased and the impedance matched to the signal input. For example, if a 50Ω source biased to 2.5V provides the input, the alternate input should be tied to 2.5V through 50Ω. If a 50Ω source is ac-coupled to the input, the alternate input should be ac-coupled to ground through 50Ω. Note that the ac coupling should provide a similar frequency response to balance the gain over frequency.

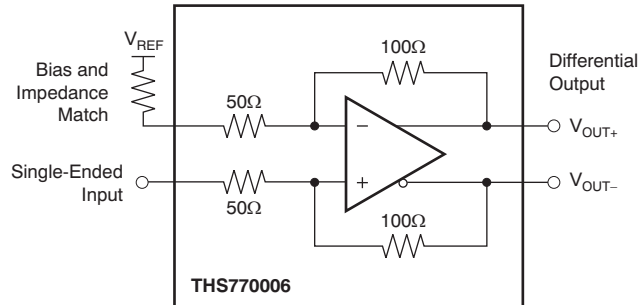

**Figure 35. Single-Ended Input to Differential Output Amplifier**

## Setting the Output Common-Mode Voltage

The  $V_{OCM}$  input controls the output common-mode voltage.  $V_{OCM}$  has no internal biasing network and must be driven by an external source or resistor divider network to the positive power supply. In ac-coupled applications, the  $V_{OCM}$  input impedance and bias current are not critical, but in dc-coupled applications where more accuracy is desired, the input bias current of the pin should be considered. For best harmonic distortion with  $V_{OUT} = 3V_{PP}$ , the  $V_{OCM}$  input should be maintained within the operating range of 2.25V to 2.75V. The  $V_{OCM}$  input voltage can be operated outside this range if lower output swing is used or distortion degradation is allowed, and increased bias current into the pin is acceptable. For more information, see [Figure 12](#) and [Figure 31](#). It is recommended to use a 0.1μF decoupling capacitor from the  $V_{OCM}$  pin to ground to prevent noise and other spurious signals from coupling into the common-mode loop of the amplifier.

## Input Common-Mode Voltage Range

The THS770006 is designed primarily for ac-coupled operation. With input dc blocking, the input common-mode voltage of the device is driven to the same voltage as  $V_{OCM}$  by the outputs. Therefore, as long as the  $V_{OCM}$  input is maintained within the operating range of 2.25V to 2.75V, the input common-mode of the main amplifier is also maintained within its linear operating range of 2.25V to 2.75V. If the device is used with dc coupled input, the driving source needs to bias the input to its linear operating range of 2.25V to 2.75V for proper operation.

## Operation with Split Supply ±2.5V

The THS770006 can be operated using a split ±2.5V supply. In this case,  $V_{S+}$  is connected to +2.5V, and GND (and any other pin noted to be connected to GND) is connected to -2.5V. As with any device, the THS770006 is impervious to what the user decides to name the levels in the system. In essence, it is simply a level shift of the power pins by -2.5V. If everything else is level-shifted by the same amount, the device sees no difference. With a ±2.5V power supply, the  $V_{OCM}$  range is 0V ±0.25V; therefore, power-down levels are -2.5V = on and +2.5V = off, and input and output voltage ranges are symmetrical about 0V. This design has certain advantages in systems where signals are referenced to ground, and as noted in the following section, for driving ADCs with low input common-mode voltage requirements in dc-coupled applications.

## Driving Capacitive Loads

The THS770006 is tested as described previously, with the data shown in the typical graphs. As a result of the fixed gain architecture of the device, the only practical means to avoid stability problems such as overshoot/ringing, gain peaking, and oscillation when driving capacitive loads is to place small resistors in series with the outputs ( $R_O$ ) to isolate the phase shift caused by the capacitive load from the feedback loop of the amplifier. The Typical Characteristics graphs show recommended values for an optimally flat frequency response with maximum bandwidth. Smaller values of  $R_O$  can be used if more peaking is allowed, and larger values can be used to reduce the bandwidth.

## Driving ADCs

The THS770006 is designed and optimized for the highest performance to drive differential input ADCs. [Figure 36](#) shows a generic block diagram of the THS770006 driving an ADC. The primary interface circuit between the amplifier and the ADC is usually a filter of some type for antialias purposes, and provides a means to bias the signal to the input common-mode voltage required by the ADC. Filters range from single-order real RC poles to higher-order LC filters, depending on the requirements of the application. Output resistors ( $R_O$ ) are shown on the amplifier outputs to isolate the amplifier from any capacitive loading presented by the filter.

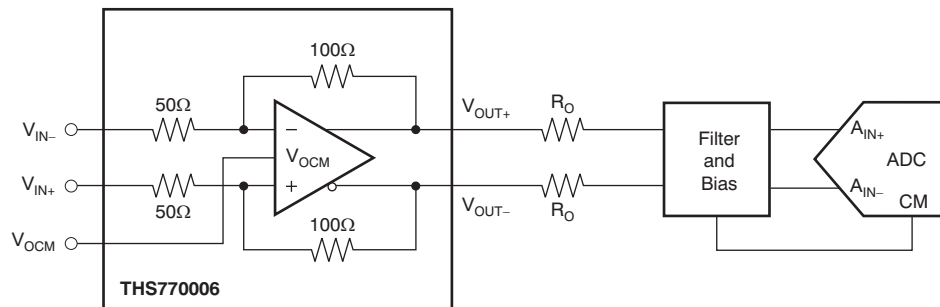

**Figure 36. Generic ADC Driver Block Diagram**

The key points to consider for implementation are described in the following three subsections.

### SNR Considerations

The signal-to-noise ratio (SNR) of the amplifier and filter can be calculated from the amplitude of the signal and the bandwidth of the filter. The noise from the amplifier is band-limited by the filter with the equivalent brick-wall filter bandwidth. The amplifier and filter noise can be calculated using the following equations:

$$\text{SNR}_{\text{AMP+FILTER}} = 10 \cdot \log \left( \frac{V_O^2}{e_{\text{FILTEROUT}}^2} \right) = 20 \cdot \log \left( \frac{V_O}{e_{\text{FILTEROUT}}} \right)$$

Where:

$$e_{\text{FILTEROUT}} = e_{\text{NAMPOUT}} \cdot \sqrt{\text{ENB}}$$

$e_{\text{NAMPOUT}}$  = the output noise density of the THS770006 ( $3.4\text{nV}/\sqrt{\text{Hz}}$ )

ENB = the brick-wall equivalent noise bandwidth of the filter

$V_O$  is the amplifier output signal.

(1)

For example, with a first-order ( $N = 1$ ) band-pass or low-pass filter with 30MHz cutoff, the ENB is  $1.57 \cdot f_{-3\text{dB}} = 1.57 \cdot 30\text{MHz} = 47.1\text{MHz}$ . For second-order ( $N = 2$ ) filters, the ENB is  $1.22 \cdot f_{-3\text{dB}}$ . As the filter order increases, the ENB approaches  $f_{-3\text{dB}}$  ( $N = 3 \rightarrow \text{ENB} = 1.15 \cdot f_{-3\text{dB}}$ ;  $N = 4 \rightarrow \text{ENB} = 1.13 \cdot f_{-3\text{dB}}$ ). Both  $V_O$  and  $e_{\text{FILTEROUT}}$  are in RMS voltages. For example, with a  $2V_{\text{PP}}$  ( $0.707V_{\text{RMS}}$ ) output signal and 30MHz first-order filter, the SNR of the amplifier and filter is 70.7dB with  $e_{\text{FILTEROUT}} = 3.4\text{nV}/\sqrt{\text{Hz}} \cdot \sqrt{47.1\text{MHz}} = 23\mu\text{V}_{\text{RMS}}$ .

The SNR of the amplifier, filter, and ADC sum in RMS fashion, as shown in [Equation 2](#) (SNR values in dB):

$$\text{SNR}_{\text{SYSTEM}} = -20 \cdot \log \left( \sqrt{10^{\frac{-\text{SNR}_{\text{AMP+FILTER}}}{10}} + 10^{\frac{-\text{SNR}_{\text{ADC}}}{10}}} \right)$$

(2)

This formula shows that if the SNR of the amplifier and filter equals the SNR of the ADC, the combined SNR is 3dB lower (worse). Thus, for minimal impact (< 1dB) on the ADC SNR, the SNR of the amplifier and filter should be  $\geq 10$ dB greater than the ADC SNR. The combined SNR calculated in this manner is usually accurate to within  $\pm 1$ dB of actual implementation.

### SFDR Considerations

The SFDR of the amplifier is usually set by second-order or third-order harmonic distortion for single-tone inputs, and by second-order or third-order intermodulation distortion for two-tone inputs. Harmonics and second-order intermodulation distortion can be filtered to some degree, but third-order intermodulation spurs cannot be filtered. The ADC generates the same distortion products as the amplifier, but as a result of the sampling and clock feedthrough, additional spurs (not linearly related to the input signal) are included.

When the spurs from the amplifier and filter are known, each individual spur can be directly added to the same spur from the ADC, as shown in [Equation 3](#), to estimate the combined spur (spur amplitudes in dBc):

$$HDX_{SYSTEM} = -20 \cdot \log \left( 10^{\frac{-HDX_{AMP+FILTER}}{20}} + 10^{\frac{-HDX_{ADC}}{20}} \right) \quad (3)$$

This calculation assumes the spurs are in phase, but usually provides a good estimate of the final combined distortion.

For example, if the spur of the amplifier and filter equals the spur of the ADC, then the combined spur is 6dB higher. To minimize the amplifier contribution (< 1dB) to the overall system distortion, it is important that the spur from the amplifier and filter be  $\sim 15$ dB better than the converter. The combined spur calculated in this manner is usually accurate to within  $\pm 6$ dB of actual implementation; however, higher variations have been observed as a result of phase shift in the filter, especially in second-order harmonic performance.

This worst-case spur calculation assumes that the amplifier/filter spur of interest is in phase with the corresponding spur in the ADC, such that the two spur amplitudes can be added linearly. There are two phase-shift mechanisms that cause the measured distortion performance of the amplifier-ADC chain to deviate from the expected performance calculated using [Equation 3](#): common-mode phase shift and differential phase shift.

*Common-mode phase shift* is the phase shift seen equally in both branches of the differential signal path including the filter. Common-mode phase shift nullifies the basic assumption that the amplifier/filter and ADC spur sources are in phase. This phase shift can lead to better performance than predicted as the spurs become phase shifted, and there is the potential for cancellation as the phase shift reaches  $180^\circ$ . However, there is a significant challenge in designing an amplifier-ADC interface circuit to take advantage of common-mode phase shift for cancellation: the phase characteristic of the ADC spur sources are unknown, thus the necessary phase shift in the filter and signal path for cancellation is also unknown.

*Differential phase shift* is the difference in the phase response between the two branches of the differential filter signal path. Differential phase shift in the filter as a result of mismatched components caused by nominal tolerance can severely degrade the even-order distortion of the amplifier-ADC chain. This effect has the same result as mismatched path lengths for the two differential traces, and causes more phase shift in one path than the other. Ideally, the phase response over frequency through the two sides of a differential signal path are identical, such that even-order harmonics remain optimally out of phase and cancel when the signal is taken differentially. However, if one side has more phase shift than the other, then the even-order harmonic cancellation is not as effective.

Single-order RC filters cause very little differential phase shift with nominal tolerances of 5% or less, but higher-order LC filters are very sensitive to component mismatch. For instance, a third-order Butterworth bandpass filter with 100MHz center frequency and 20MHz bandwidth shows up to a  $20^\circ$  differential phase imbalance in a Spice Monte Carlo analysis with 2% component tolerances. Therefore, while a prototype may work, production variance is unacceptable. In ac-coupled applications that require second- and higher-order filters between the THS770006 and ADC, a transformer or balun is recommended at the ADC input to restore the phase balance. For dc-coupled applications where a transformer or balun at the ADC input cannot be used, it is recommended to use first- or second-order filters to minimize the effect of differential phase shift because of component tolerance.

### ADC Input Common-Mode Voltage Considerations—AC-Coupled Input

The input common-mode voltage range of the ADC must be respected for proper operation. In an ac-coupled application between the amplifier and the ADC, the input common-mode voltage bias of the ADC is accomplished in different ways depending on the ADC. Some ADCs use internal bias networks such that the analog inputs are automatically biased to the required input common-mode voltage if the inputs are ac-coupled with capacitors (or if the filter between the amplifier and ADC is a bandpass filter). Other ADCs supply their required input common-mode voltage from a reference voltage output pin (often called CM or  $V_{CM}$ ). With these ADCs, the ac-coupled input signal can be re-biased to the input common-mode voltage by connecting resistors from each input to the CM output of the ADC, as Figure 37 illustrates. However, the signal is attenuated because of the voltage divider created by  $R_{CM}$  and  $R_O$ .

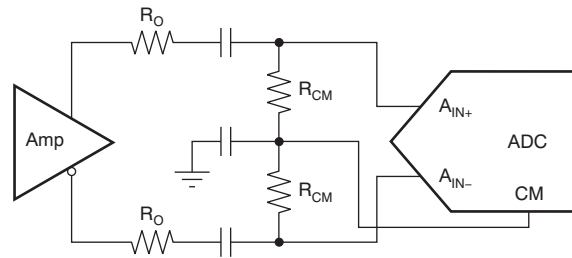
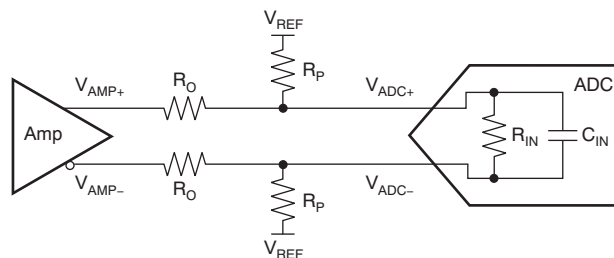

**Figure 37. Biasing AC-Coupled ADC Inputs Using the ADC CM Output**

The signal can be re-biased when ac coupling; thus, the output common-mode voltage of the amplifier is a *don't care* for the ADC.

### ADC Input Common-Mode Voltage Considerations—DC-Coupled Input

DC-coupled applications vary in complexity and requirements, depending on the ADC. One typical requirement is resolving the mismatch between the common-mode voltage of the driving amplifier and the ADC. Devices such as the ADS5424 require a nominal 2.4V input common-mode, while others such as the ADS5485 require a nominal 3.1V input common-mode; still others such as the ADS6149 and the ADS4149 require 1.5V and 0.95V, respectively. As shown in Figure 38, a resistor network can be used to perform a common-mode level shift. This resistor network consists of the amplifier series output resistors and pull-up or pull-down resistors to a reference voltage. This resistor network introduces signal attenuation that may prevent the use of the full-scale input range of the ADC. ADCs with an input common-mode closer to the typical 2.5V THS770006 output common-mode are easier to dc-couple, and require little or no level shifting.



**Figure 38. Resistor Network to DC Level-Shift Common-Mode Voltage**

For common-mode analysis of the circuit in Figure 38, assume that  $V_{AMP\pm} = V_{OCM}$  and  $V_{ADC\pm} = V_{CM}$  (the specification for the ADC input common-mode voltage).  $V_{REF}$  is chosen to be a voltage within the system higher than  $V_{CM}$  (such as the ADC or amplifier analog supply) or ground, depending on whether the voltage must be pulled up or down, respectively;  $R_O$  is chosen to be a reasonable value, such as 24.9Ω. With these known values,  $R_P$  can be found by using Equation 4:

$$R_P = R_O \left( \frac{V_{ADC} - V_{REF}}{V_{AMP} - V_{ADC}} \right) \quad (4)$$



Shifting the common-mode voltage with the resistor network comes at the expense of signal attenuation. Modeling the ADC input as the parallel combination of a resistance ( $R_{IN}$ ) and capacitance ( $C_{IN}$ ) using values taken from the ADC data sheet, the approximate differential input impedance ( $Z_{IN}$ ) for the ADC can be calculated at the signal frequency. The effect of  $C_{IN}$  on the overall calculation of gain is typically minimal and can be ignored for simplicity (that is,  $Z_{IN} = R_{IN}$ ). The ADC input impedance creates a divider with the resistor network; the gain (attenuation) for this divider can be calculated by [Equation 5](#):

$$GAIN = \left( \frac{2R_P \parallel Z_{IN}}{2R_O + 2R_P \parallel Z_{IN}} \right) \quad (5)$$

With ADCs that have internal resistors that bias the ADC input to the ADC input common-mode voltage, the effective  $R_{IN}$  is equal to twice the value of the bias resistor. For example, the ADS5485 has a 1k $\Omega$  resistor tying each input to the ADC  $V_{CM}$ ; therefore, the effective differential  $R_{IN}$  is 2k $\Omega$ .

The introduction of the  $R_P$  resistors also modifies the effective load seen by the amplifier. [Equation 6](#) shows the effective load seen by the amplifier:

$$R_L = 2R_O + 2R_P \parallel Z_{IN} \quad (6)$$

The  $R_P$  resistors act in parallel to the ADC input such that the effective load (output current) seen by the amplifier is increased. Higher current loads limit the THS770006 differential output swing.

Using the gain and knowing the full-scale input of the ADC ( $V_{ADC\ FS}$ ), the required amplitude to drive the ADC with the network can be calculated using [Equation 7](#):

$$V_{AMP\ PP} = \frac{V_{ADC\ FS}}{GAIN} \quad (7)$$

Using the ADC examples given previously, [Table 2](#) shows sample calculations of the value of  $R_P$  and  $V_{AMP\ FS}$  for full-scale drive, and then for -1dB (often times, the ADC drive is backed off from full-scale in applications, so lower amplitudes may be acceptable). All voltage values are in volts, resistor values in ohms (the nearest standard value should be used), and gain values are as noted. [Table 2](#) does not include the ADS5424 because no level shift is required with this device.

**Table 2. Example  $R_P$  for Various ADCs**

| ADC     | $V_{AMP}$<br>(V <sub>DC</sub> ) | $V_{ADC}$<br>(V <sub>DC</sub> ) | $V_{REF}$<br>(V <sub>DC</sub> ) | ADC $R_{IN}$<br>( $\Omega$ ) | $R_O$<br>( $\Omega$ ) | $R_P$<br>( $\Omega$ ) | GAIN<br>(V/V) | GAIN<br>(dB) | $V_{ADC\ FS}$<br>(V <sub>PP</sub> ) | $V_{AMP\ PP}$<br>FOR<br>0dBFS(V <sub>PP</sub> ) | $V_{AMP\ PP}$<br>FOR -1dBFS<br>(V <sub>PP</sub> ) |
|---------|---------------------------------|---------------------------------|---------------------------------|------------------------------|-----------------------|-----------------------|---------------|--------------|-------------------------------------|---|---|
| ADS5485 | 2.5                             | 3.1                             | 5                               | 2k                           | 50                    | 158.3                 | 0.73          | -2.72        | 3                                   | 4.10  | 3.66  |
| ADS6149 | 2.5                             | 1.5                             | 0                               | 6k <sup>(1)</sup>            | 50                    | 75.0                  | 0.59          | -4.56        | 2                                   | 3.38  | 3.01  |
| ADS4149 | 2.5                             | 0.95                            | 0                               | 5k <sup>(1)</sup>            | 50                    | 30.6                  | 0.38          | -8.49        | 2                                   | 5.31  | 4.74  |
|         | 0 <sup>(2)</sup>                | 0.95                            | 2.5                             | 5k <sup>(1)</sup>            | 50                    | 81.6                  | 0.61          | -4.31        | 2                                   | 3.28  | 2.93  |
|         | 0 <sup>(2)</sup>                | 0.95                            | 5                               | 5k <sup>(1)</sup>            | 50                    | 213.2                 | 0.79          | -2.05        | 2                                   | 2.53  | 2.26  |

(1) At 70MHz.

(2) THS770006 with  $\pm 2.5V$  supply.

The calculated values for the ADS5485 give the lowest attenuation. As a result of the high  $V_{FS}$  of  $3V_{PP}$ ,  $3.66V_{PP}$  is required from the amplifier to drive to  $-1dBFS$ . Performance of the THS770006 is still very good up to 130MHz at this level, but for best performance, back off further from full-scale and consider trading reduced SNR performance for better SFDR performance.

The values calculated for the ADS6149 show reasonable design targets and should work with good performance. Note the ADS6149 does not have buffered inputs, and the inputs have equivalent resistive impedance that varies with sampling frequency. The calculation shown in [Table 2](#) uses a value of 70MHz for  $R_{IN}$ , taken from the [ADS6149 data sheet](#).

The values calculated for the low input common-mode voltage of the ADS4149 result in a large attenuation of the amplifier signal leading to  $5.31V_{PP}$  being required for full-scale ADC drive. This amplitude is greater than the maximum capability of the device. With a single +5V supply, the THS770006 is not suitable to drive this ADC in dc-coupled applications unless the ADC input is backed off towards  $-6dBFS$ .

Another option is to operate the THS770006 with a split  $\pm 2.5V$  supply. The  $R_p$  and gains are shown in the last two rows of [Table 2](#) for pull-up voltages of 2.5V and 5V. For this situation, if the +2.5V is used as the pull-up reference voltage, only  $2.93V_{PP}$  is required for the  $-1dBFS$  input to the ADS4149. If a 5V reference is used, only  $2.26V_{PP}$  is required to reach the  $-1dBFS$  input to the ADS4149. See the [Operation with Split Supply  \$\pm 2.5V\$](#)  section for more detail. Note that, similar to the ADS6149, the ADS4149 does not have buffered inputs and the inputs have equivalent resistive impedance that varies with sampling frequency. The  $R_{IN}$  value at 70MHz taken from the ADS4149 data sheet was used in the calculation.

As with any design, testing is recommended to validate whether it meets the specific design goals.



## APPLICATION INFORMATION

### THS770006 DRIVING 16-BIT ADC

To illustrate the performance of the THS770006 as an ADC driver, the device is tested with a 16-bit ADC.

#### TESTING WITH AN AC-COUPLED BANDPASS FILTER

For testing purposes, a 30MHz, third-order Butterworth bandpass filter with center frequency at 100MHz is designed. The design target for the source impedance is 40Ω differential, and for load impedance is 400Ω differential. Therefore, approximately 1dB insertion loss is expected in the pass-band, requiring the amplifier output amplitude to be 2.5V<sub>PP</sub> to drive the ADC to –1dBFS.

The output noise voltage specification for the THS770006 is 3.4 nV/√Hz. With 2.5V<sub>PP</sub> amplifier output voltage swing and 30MHz bandwidth, the expected SNR from the amplifier + antialias filter is 93.5dB. When added in combination with the 16-bit ADC, the expected total SNR is 75.1dBFS for the typical case.

[Figure 39](#) shows the resulting FFT plot when driving the ADC to –1dBFS with a single-tone 100MHz sine wave, and sampling at 125MSPS. Test results show 98dBc SFDR from the second-order harmonic and 75.6 dBFS SNR; analysis of the plot is shown in [Table 3](#) versus typical ADC specifications. The test results from circuit board to circuit board shows over 10dB of variation in the second order harmonic and a balun is inserted between the filter and ADC inputs to get repeatable performance. With balun, the minimum expected results should be better than 90dBc SFDR and 75dBFS SNR.

[Figure 39](#) shows the same circuit with a two-tone input at 96MHz and 100MHz. The near-in 3<sup>rd</sup> order intermodulation terms are about -100dBc.

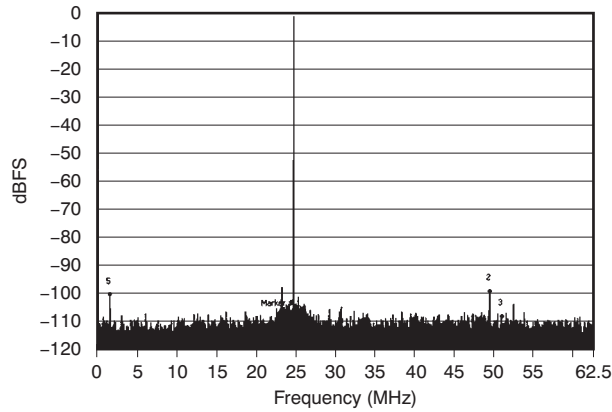

Figure 39. FFT Plot of THS770006 + 30MHz BPF + 16-Bit ADC with Single-Tone at 100MHz

Table 3. Analysis of FFT for THS770006 + BPF + 16-Bit ADC at 100MHz vs Typical ADC Specifications

| CONFIGURATION                | ADC INPUT | SNR      | HD2     | HD3     |
|------------------------------|-----------|----------|---------|---------|
| THS770006 + BPF + 16-Bit ADC | -1dBFS    | 75.6dBFS | -98dBc  | -107dBc |
| 16-Bit ADC Only (typ)        | -1dBFS    | 75.2dBFS | -100dBc | -100dBc |

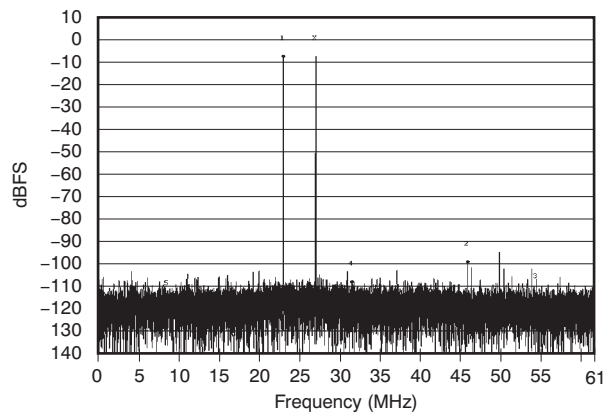

Figure 40. FFT Plot of THS770006 + 30MHz BPF + 16-Bit ADC with Two-Tone Input at 96MHz and 100MHz

## TESTING WITH AN AC-COUPLED LOW-PASS FILTER

For testing purposes, a 150MHz, first-order, low-pass filter is built. The design gives approximately 1.6dB insertion loss at low frequency, requiring the amplifier signal be  $2.7V_{PP}$  in order to drive the ADC to  $-1dBFS$ .

With  $2.7V_{PP}$  amplifier output voltage swing and 180MHz ( $-3dB$ ) bandwidth, the expected SNR from the amplifier + antialias filter is 84.4dB. When added in combination with the 16-bit, 130MSPS ADC, the total expected SNR is 74.7dBFS for the typical case. Note the frequency response is approximately  $-1dB$  at 100MHz, which requires even higher amplitude for the following test.

Figure 41 shows the resulting FFT plot when driving the ADC to  $-1dBFS$  with a 100MHz sine wave, and sampling at 125MSPS. Test results showed 91dBc SFDR from second- and third-order harmonic and 73.1dBFS SNR; analysis of the plot is shown in Table 4 versus typical ADC specifications. As a result of harmonic attenuation and phase shift between the amplifier and ADC, harmonic performance is better than predicted from the worst-case scenario described previously. Typical expected results should be approximately 90dBc SFDR and 73dBFS SNR.

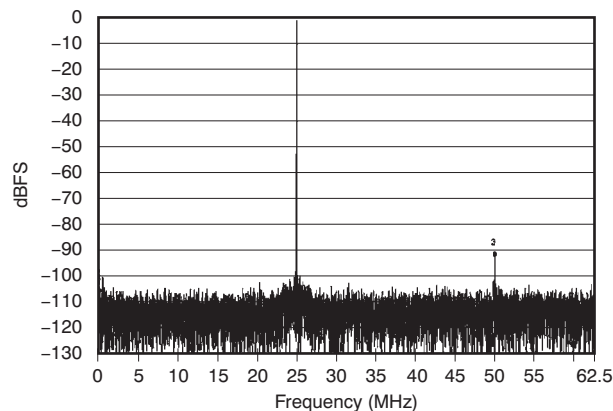

**Figure 41. FFT Plot of THS770006 + 180MHz LPF + 16-Bit ADC with Single-Tone at 100MHz**

**Table 4. Analysis of FFT for THS770006 + 180MHz LPF + 16-Bit ADC at 100MHz vs Typical ADC Specifications**

| CONFIGURATION                | ADC INPUT | SNR      | HD2       | HD3       |
|------------------------------|-----------|----------|-----------|-----------|
| THS770006 + BPF + 16-Bit ADC | $-1dBFS$  | 73.1dBFS | $-91dBc$  | $-91dBc$  |
| 16-Bit ADC Only (typ)        | $-1dBFS$  | 75.2dBFS | $-100dBc$ | $-100dBc$ |

### EVM AND LAYOUT RECOMMENDATIONS

Figure 33 is the THS770006RGE EVM schematic, and Figure 42 through Figure 45 show the layout details of the EVM PCB. Table 5 is the bill of materials for the EVM as supplied from TI. It is recommended to follow the layout of the external components as close as possible to the amplifier, ground plane construction, and power routing. General layout guidelines are:

1. Place a 2.2μF to 10μF capacitor on each supply pin within 2 inches from the device. It can be shared among other op amps.
2. Place a 0.01μF to 0.1μF capacitor on each supply pin to ground as close as possible to the device. Placement within 1mm of the device supply pins ensures best performance.
3. Keep input and output traces as short as possible to minimize parasitic capacitance and inductance. Doing so reduces unwanted characteristics such as reduced bandwidth and peaking in the frequency response, overshoot, and ringing in the pulse response, and results in a more stable design.
4. To reduce parasitic capacitance, ground plane and power-supply planes should be removed from device input pins and output pins.
5. The V<sub>OCM</sub> pin must be biased to a voltage between 2.25V to 2.75V for proper operation. Place a 0.1μF to 0.22μF capacitor to ground as close as possible to the device to prevent noise coupling into the common-mode.
6. For best performance, drive circuits and loads should be balanced and biased to keep the input and output common-mode voltage between 2.25V to 2.75V. AC-coupling is a simple way to achieve this performance.
7. The THS770006 is provided in a thermally enhanced PowerPAD™ package. The package is constructed using a downset leadframe on which the die is mounted. This arrangement results in low thermal resistance to the thermal pad on the underside of the package. Excellent thermal performance can be achieved by following the guidelines in TI application reports [SLMA002, PowerPAD™ Thermally-Enhanced Package](#) and [SLMA004, PowerPAD™ Made Easy](#). For proper operation, the thermal pad on the bottom of the device must be tied to the same voltage potential as the GND pin on the device.

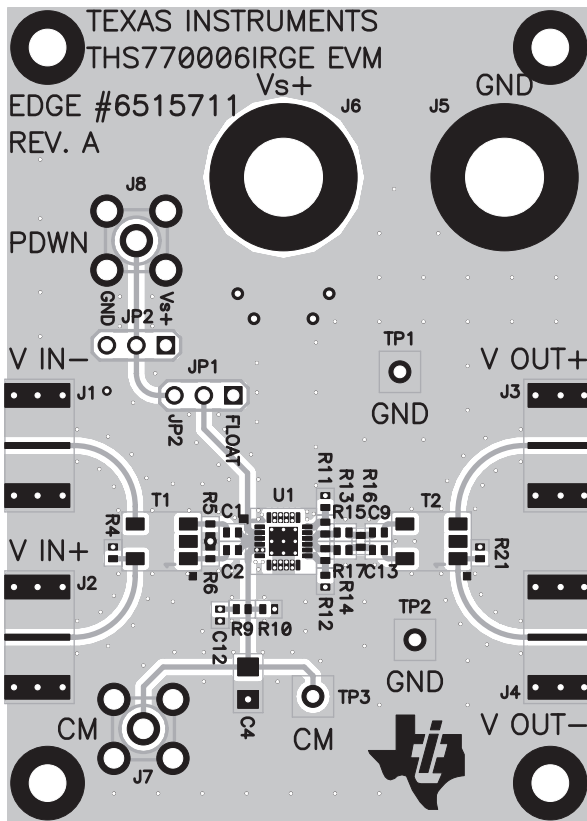

Figure 42. EVM Layout: Top Layer

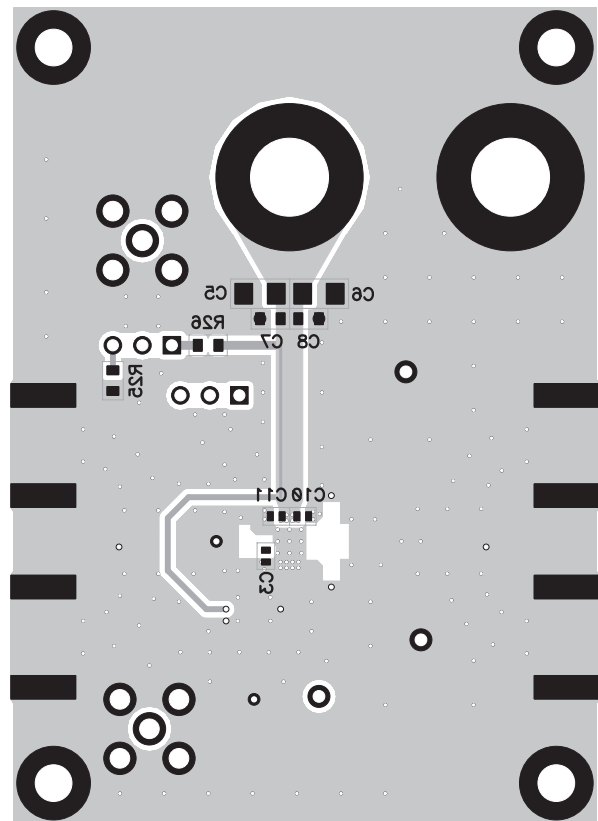

Figure 43. EVM Layout: Bottom Layer

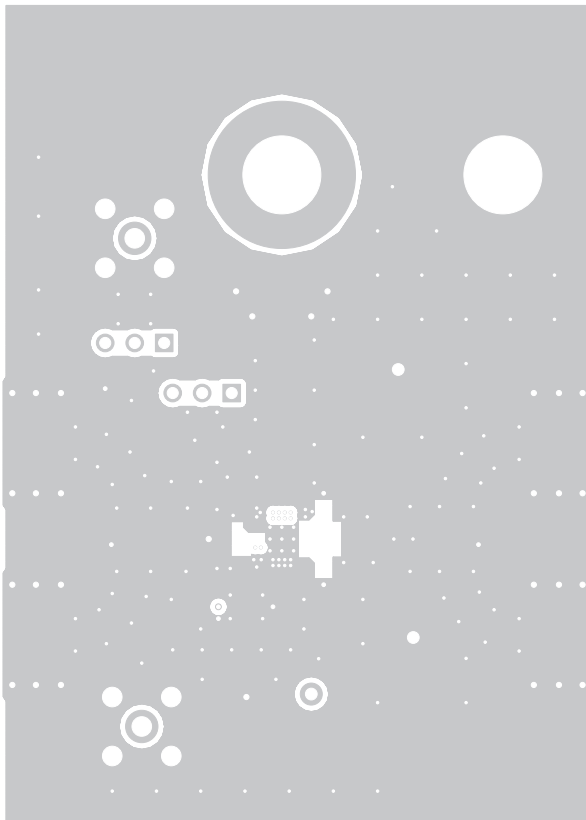

Figure 44. EVM Layout: Layer 2

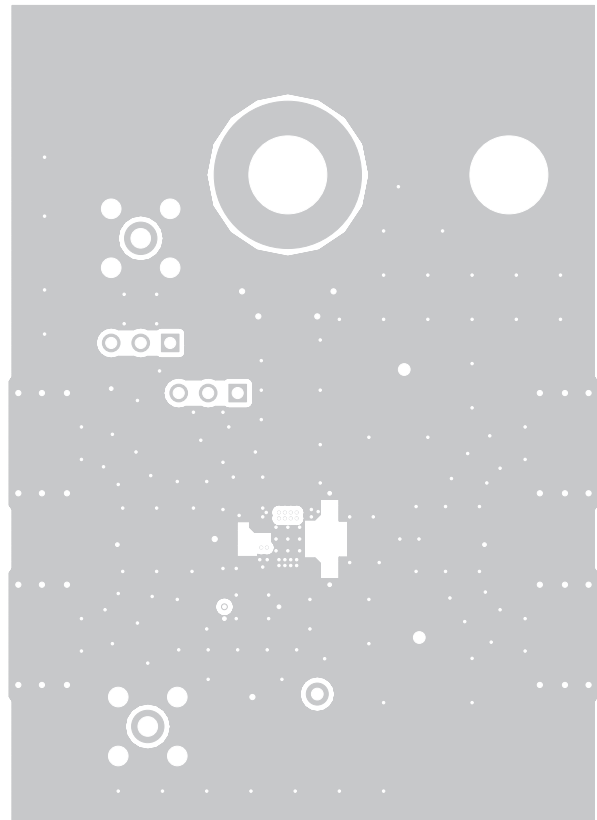

Figure 45. EVM Layout: Layer 3

**Table 5. THS770006RGE EVM Bill of Materials**

| ITEM | DESCRIPTION                              | SMD SIZE | REFERENCE DESIGNATOR | QTY | MANUFACTURER PART NUMBER  | DISTRIBUTOR PART NUMBER  |
|------|--|----------|----------------------|-----|---------------------------|--------------------------|
| 1    | CAP, 10.0uF, CERAMIC, X7R, 10V           | 1206     | C4, C5, C6           | 3   | (TDK) C3216X7R1A106K      | (DIGI-KEY) 445-4043-1-ND |
| 2    | CAP, 0.1uF, CERAMIC, X7R, 16V            | 0603     | C7, C8               | 2   | (AVX) 0603YC104KAT2A      | (DIGI-KEY) 478-1239-1-ND |
| 3    | CAP, 0.01uF, CERAMIC, X7R, 16V           | 0402     | C10, C11             | 2   | (AVX) 0402YC103KAT2A      | (DIGI-KEY) 478-1114-1-ND |
| 4    | CAP, 100pF, CERAMIC, NPO, 50V            | 0402     | C12                  | 1   | (AVX) 04025A101KAT2A      | (DIGI-KEY) 478-4979-1-ND |
| 5    | CAP, 1000pF, CERAMIC, X7R, 50V           | 0402     | C1, C2, C3, C9, C13  | 5   | (AVX) 04025C102KAT2A      | (DIGI-KEY) 478-1101-1-ND |
| 6    | OPEN                                     | 0402     | R11, R12, R13, R14   | 4   |                           |                          |
| 7    | RESISTOR, 0 OHM                          | 0402     | R4, R21              | 2   | (PANASONIC) ERJ-2GE0R00X  | (DIGI-KEY) P0.0JCT-ND    |
| 8    | RESISTOR, 49.9 OHM, 1/10W, 1%            | 0402     | R5, R6               | 2   | (PANASONIC) ERJ-2RKF49R9X | (DIGI-KEY) P49.9LCT-ND   |
| 9    | RESISTOR, 57.6 OHM, 1/10W, 1%            | 0402     | R16                  | 1   | (PANASONIC) ERJ-2RKF57R6X | (DIGI-KEY) P57.6LCT-ND   |
| 10   | RESISTOR, 187 OHM, 1/10W, 1%             | 0402     | R15, R17             | 2   | (PANASONIC) ERJ-2RKF1870X | (DIGI-KEY) P187LCT-ND    |
| 11   | RESISTOR, 1K OHM, 1/10W, 1%              | 0402     | R9, R10              | 2   | (PANASONIC) ERJ-2RKF1001X | (DIGI-KEY) P1.00KLCT-ND  |
| 12   | RESISTOR, 10K OHM, 1/10W, 1%             | 0603     | R25, R26             | 2   | (PANASONIC) ERJ-3EKF1002V | (DIGI-KEY) P10.0KHCT-ND  |
| 13   | TRANSFORMER, BALUN                       |          | T1, T2               | 2   | (PULSE) CX2156NL          | (DIGI-KEY) 553-1499-ND   |
| 14   | JACK, BANANA RECEPTANCE, 0.25" DIA. HOLE |          | J5, J6               | 3   | (SPC) 15459               | (NEWARK) 79K5034         |
| 15   | CONNECTOR, SMA PCB JACK                  |          | J7, J8               | 2   | (AMPHENOL) 901-144-8RFX   | (NEWARK) 34C8151         |
| 16   | CONNECTOR, EDGE, SMA PCB JACK            |          | J1, J2, J3, J4       | 4   | (JOHNSON) 142-0701-801    | (NEWARK) 90F2624         |
| 17   | HEADER, 0.1" CTRS, 0.025" SQ. PINS       | 3 POS.   | JP1, JP2             | 2   | (SULLINS) PBC36SAAN       | (DIGI-KEY) S1011E-36-ND  |
| 18   | SHUNTS                                   |          | JP1, JP2             | 2   | (SULLINS) SSC02SYAN       | (DIGI-KEY) S9002-ND      |
| 19   | TEST POINT, RED                          |          | TP3                  | 1   | (KEYSTONE) 5000           | (DIGI-KEY) 5000K-ND      |
| 20   | TEST POINT, BLACK                        |          | TP1, TP2             | 2   | (KEYSTONE) 5001           | (DIGI-KEY) 5001K-ND      |
| 21   | IC, THS770006                            |          | U1                   | 1   | (TI) THS770006RGE         |                          |
| 22   | STANDOFF, 4-40 HEX, 0.625" LENGTH        |          |                      | 4   | (KEYSTONE) 1808           | (DIGI-KEY) 1808K-ND      |
| 23   | SCREW, PHILLIPS, 4-40, .250"             |          |                      | 4   | PMSSS 440 0025 PH         | (DIGI-KEY) H703-ND       |
| 24   | BOARD, PRINTED CIRCUIT                   |          |                      |     | (TI) EDGE# 6515711 REV.A  |                          |

## REVISION HISTORY

NOTE: Page numbers for previous revisions may differ from page numbers in the current version.

| <b>Changes from Revision A (May 2011) to Revision B</b>  | <b>Page</b> |
|--|-------------|
| • Replaced "ADS5493" with "16-Bit Driver" in figure and figure title .....                           | 1           |
| • Deleted ADS5493 from Related Devices table .....   | 1           |
| • Deleted reference to ADS5493 from text .....   | 24          |
| • Replaced references to "ADS5493" with "16-bit ADC" in <i>Application Information</i> section ..... | 25          |

| <b>Changes from Original (July 2010) to Revision A</b>  | <b>Page</b> |
|---|-------------|
| • Changed large-signal bandwidth from 675 to 780 in Electrical Characteristics .....  | 3           |
| • Added new row for Input Common-Mode Range parameter in Electrical Characteristics .....                                       | 4           |
| • Added <a href="#">Figure 13</a> , Harmonic Distortion vs Input Common-Mode Range .....  | 10          |
| • Changed <a href="#">SNR Considerations</a> section. ....  | 20          |
| • Changed <a href="#">SFDR Considerations</a> section .....   | 21          |
| • Changed <a href="#">ADC Input Common-Mode Voltage Considerations</a> section to show ac-coupled input. ....                   | 22          |
| • Added new subsection titled <a href="#">ADC Input Common-Mode Voltage Considerations—DC-Coupled Input</a> .....               | 22          |
| • Deleted figure and last two paragraphs from the <a href="#">THS770006 Driving ADS5493</a> section .....                       | 25          |
| • Deleted text from first sentence in the <a href="#">Testing the ADS5493 with an AC-Coupled Bandpass Filter</a> section .....  | 25          |
| • Deleted text from first paragraph in the <a href="#">Testing the ADS5493 with an AC-Coupled Low-Pass Filter</a> section ..... | 27          |

## Evaluation Board/Kit Important Notice

Texas Instruments (TI) provides the enclosed product(s) under the following conditions:

This evaluation board/kit is intended for use for **ENGINEERING DEVELOPMENT, DEMONSTRATION, OR EVALUATION PURPOSES ONLY** and is not considered by TI to be a finished end-product fit for general consumer use. Persons handling the product(s) must have electronics training and observe good engineering practice standards. As such, the goods being provided are not intended to be complete in terms of required design-, marketing-, and/or manufacturing-related protective considerations, including product safety and environmental measures typically found in end products that incorporate such semiconductor components or circuit boards. This evaluation board/kit does not fall within the scope of the European Union directives regarding electromagnetic compatibility, restricted substances (RoHS), recycling (WEEE), FCC, CE or UL, and therefore may not meet the technical requirements of these directives or other related directives.

Should this evaluation board/kit not meet the specifications indicated in the User's Guide, the board/kit may be returned within 30 days from the date of delivery for a full refund. **THE FOREGOING WARRANTY IS THE EXCLUSIVE WARRANTY MADE BY SELLER TO BUYER AND IS IN LIEU OF ALL OTHER WARRANTIES, EXPRESSED, IMPLIED, OR STATUTORY, INCLUDING ANY WARRANTY OF MERCHANTABILITY OR FITNESS FOR ANY PARTICULAR PURPOSE.**

The user assumes all responsibility and liability for proper and safe handling of the goods. Further, the user indemnifies TI from all claims arising from the handling or use of the goods. Due to the open construction of the product, it is the user's responsibility to take any and all appropriate precautions with regard to electrostatic discharge.

**EXCEPT TO THE EXTENT OF THE INDEMNITY SET FORTH ABOVE, NEITHER PARTY SHALL BE LIABLE TO THE OTHER FOR ANY INDIRECT, SPECIAL, INCIDENTAL, OR CONSEQUENTIAL DAMAGES.**

TI currently deals with a variety of customers for products, and therefore our arrangement with the user **is not exclusive**.

TI assumes **no liability for applications assistance, customer product design, software performance, or infringement of patents or services described herein.**

Please read the User's Guide and, specifically, the Warnings and Restrictions notice in the User's Guide prior to handling the product. This notice contains important safety information about temperatures and voltages. For additional information on TI's environmental and/or safety programs, please contact the TI application engineer or visit [www.ti.com/esh](http://www.ti.com/esh).

No license is granted under any patent right or other intellectual property right of TI covering or relating to any machine, process, or combination in which such TI products or services might be or are used.

## FCC Warning

This evaluation board/kit is intended for use for **ENGINEERING DEVELOPMENT, DEMONSTRATION, OR EVALUATION PURPOSES ONLY** and is not considered by TI to be a finished end-product fit for general consumer use. It generates, uses, and can radiate radio frequency energy and has not been tested for compliance with the limits of computing devices pursuant to part 15 of FCC rules, which are designed to provide reasonable protection against radio frequency interference. Operation of this equipment in other environments may cause interference with radio communications, in which case the user at his own expense will be required to take whatever measures may be required to correct this interference.

## EVM Warnings and Restrictions

It is important to operate this EVM within the input voltage range of 0V to +5.5V and the output voltage range of 0V to +5.5V.

Exceeding the specified input range may cause unexpected operation and/or irreversible damage to the EVM. If there are questions concerning the input range, please contact a TI field representative prior to connecting the input power.

Applying loads outside of the specified output range may result in unintended operation and/or possible permanent damage to the EVM. Please consult the EVM User's Guide prior to connecting any load to the EVM output. If there is uncertainty as to the load specification, please contact a TI field representative.

During normal operation, some circuit components may have case temperatures greater than +85°C. The EVM is designed to operate properly with certain components above +85°C as long as the input and output ranges are maintained. These components include but are not limited to linear regulators, switching transistors, pass transistors, and current sense resistors. These types of devices can be identified using the EVM schematic located in the EVM User's Guide. When placing measurement probes near these devices during operation, please be aware that these devices may be very warm to the touch.

Mailing Address: Texas Instruments, Post Office Box 655303, Dallas, Texas 75265  
Copyright © 2012, Texas Instruments Incorporated



**PACKAGING INFORMATION**

| Orderable Device | Status<br>(1) | Package Type | Package Drawing | Pins | Package Qty | Eco Plan<br>(2)         | Lead/Ball Finish<br>(6) | MSL Peak Temp<br>(3) | Op Temp (°C) | Device Marking<br>(4/5) | Samples                 |
|------------------|---------------|--------------|-----------------|------|-------------|-------------------------|-------------------------|----------------------|--------------|-------------------------|-------------------------|
| THS770006IRGER   | ACTIVE        | VQFN         | RGE             | 24   | 3000        | Green (RoHS & no Sb/Br) | NIPDAU                  | Level-2-260C-1 YEAR  | -40 to 85    | THS7700<br>06IRGE       | <a href="#">Samples</a> |
| THS770006IRGET   | ACTIVE        | VQFN         | RGE             | 24   | 250         | Green (RoHS & no Sb/Br) | NIPDAU                  | Level-2-260C-1 YEAR  | -40 to 85    | THS7700<br>06IRGE       | <a href="#">Samples</a> |

(1) The marketing status values are defined as follows:

**ACTIVE:** Product device recommended for new designs.

**LIFEBUY:** TI has announced that the device will be discontinued, and a lifetime-buy period is in effect.

**NRND:** Not recommended for new designs. Device is in production to support existing customers, but TI does not recommend using this part in a new design.

**PREVIEW:** Device has been announced but is not in production. Samples may or may not be available.

**OBSOLETE:** TI has discontinued the production of the device.

(2) **RoHS:** TI defines "RoHS" to mean semiconductor products that are compliant with the current EU RoHS requirements for all 10 RoHS substances, including the requirement that RoHS substance do not exceed 0.1% by weight in homogeneous materials. Where designed to be soldered at high temperatures, "RoHS" products are suitable for use in specified lead-free processes. TI may reference these types of products as "Pb-Free".

**RoHS Exempt:** TI defines "RoHS Exempt" to mean products that contain lead but are compliant with EU RoHS pursuant to a specific EU RoHS exemption.

**Green:** TI defines "Green" to mean the content of Chlorine (Cl) and Bromine (Br) based flame retardants meet JS709B low halogen requirements of <=1000ppm threshold. Antimony trioxide based flame retardants must also meet the <=1000ppm threshold requirement.

(3) MSL, Peak Temp. - The Moisture Sensitivity Level rating according to the JEDEC industry standard classifications, and peak solder temperature.

(4) There may be additional marking, which relates to the logo, the lot trace code information, or the environmental category on the device.

(5) Multiple Device Markings will be inside parentheses. Only one Device Marking contained in parentheses and separated by a "~" will appear on a device. If a line is indented then it is a continuation of the previous line and the two combined represent the entire Device Marking for that device.

(6) Lead/Ball Finish - Orderable Devices may have multiple material finish options. Finish options are separated by a vertical ruled line. Lead/Ball Finish values may wrap to two lines if the finish value exceeds the maximum column width.

**Important Information and Disclaimer:**The information provided on this page represents TI's knowledge and belief as of the date that it is provided. TI bases its knowledge and belief on information provided by third parties, and makes no representation or warranty as to the accuracy of such information. Efforts are underway to better integrate information from third parties. TI has taken and continues to take reasonable steps to provide representative and accurate information but may not have conducted destructive testing or chemical analysis on incoming materials and chemicals. TI and TI suppliers consider certain information to be proprietary, and thus CAS numbers and other limited information may not be available for release.

In no event shall TI's liability arising out of such information exceed the total purchase price of the TI part(s) at issue in this document sold by TI to Customer on an annual basis.



**TAPE AND REEL INFORMATION**

**REEL DIMENSIONS**

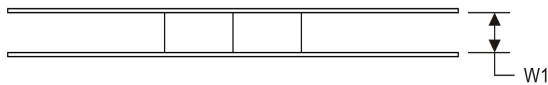
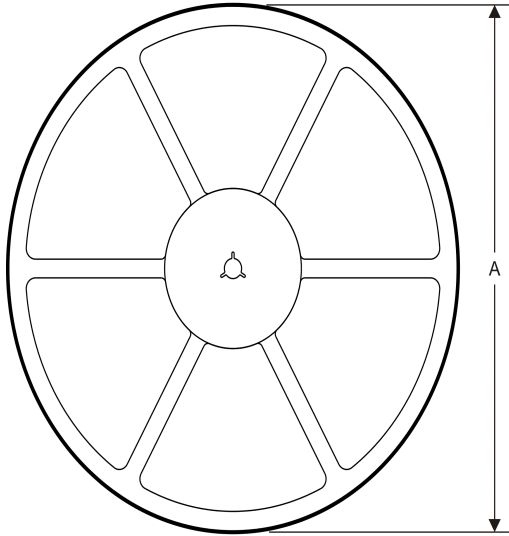

**TAPE DIMENSIONS**

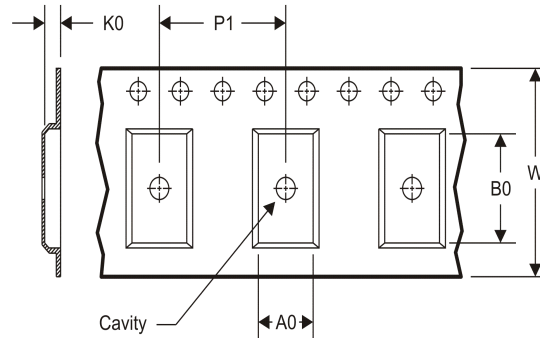

|    |   |
|----|---|
| A0 | Dimension designed to accommodate the component width     |
| B0 | Dimension designed to accommodate the component length    |
| K0 | Dimension designed to accommodate the component thickness |
| W  | Overall width of the carrier tape                         |
| P1 | Pitch between successive cavity centers                   |

**TAPE AND REEL INFORMATION**

\*All dimensions are nominal

| Device         | Package Type | Package Drawing | Pins | SPQ  | Reel Diameter (mm) | Reel Width W1 (mm) | A0 (mm) | B0 (mm) | K0 (mm) | P1 (mm) | W (mm) | Pin1 Quadrant |
|----------------|--------------|-----------------|------|------|--------------------|--------------------|---------|---------|---------|---------|--------|---------------|
| THS770006IRGER | VQFN         | RGE             | 24   | 3000 | 330.0              | 12.4               | 4.25    | 4.25    | 1.15    | 8.0     | 12.0   | Q2            |
| THS770006IRGET | VQFN         | RGE             | 24   | 250  | 180.0              | 12.4               | 4.25    | 4.25    | 1.15    | 8.0     | 12.0   | Q2            |

**TAPE AND REEL BOX DIMENSIONS**

\*All dimensions are nominal

| Device         | Package Type | Package Drawing | Pins | SPQ  | Length (mm) | Width (mm) | Height (mm) |
|----------------|--------------|-----------------|------|------|-------------|------------|-------------|
| THS770006IRGER | VQFN         | RGE             | 24   | 3000 | 367.0       | 367.0      | 35.0        |
| THS770006IRGET | VQFN         | RGE             | 24   | 250  | 210.0       | 185.0      | 35.0        |

**RGE 24**

**GENERIC PACKAGE VIEW**

**VQFN - 1 mm max height**

PLASTIC QUAD FLATPACK - NO LEAD



Images above are just a representation of the package family, actual package may vary.  
Refer to the product data sheet for package details.

4204104/H

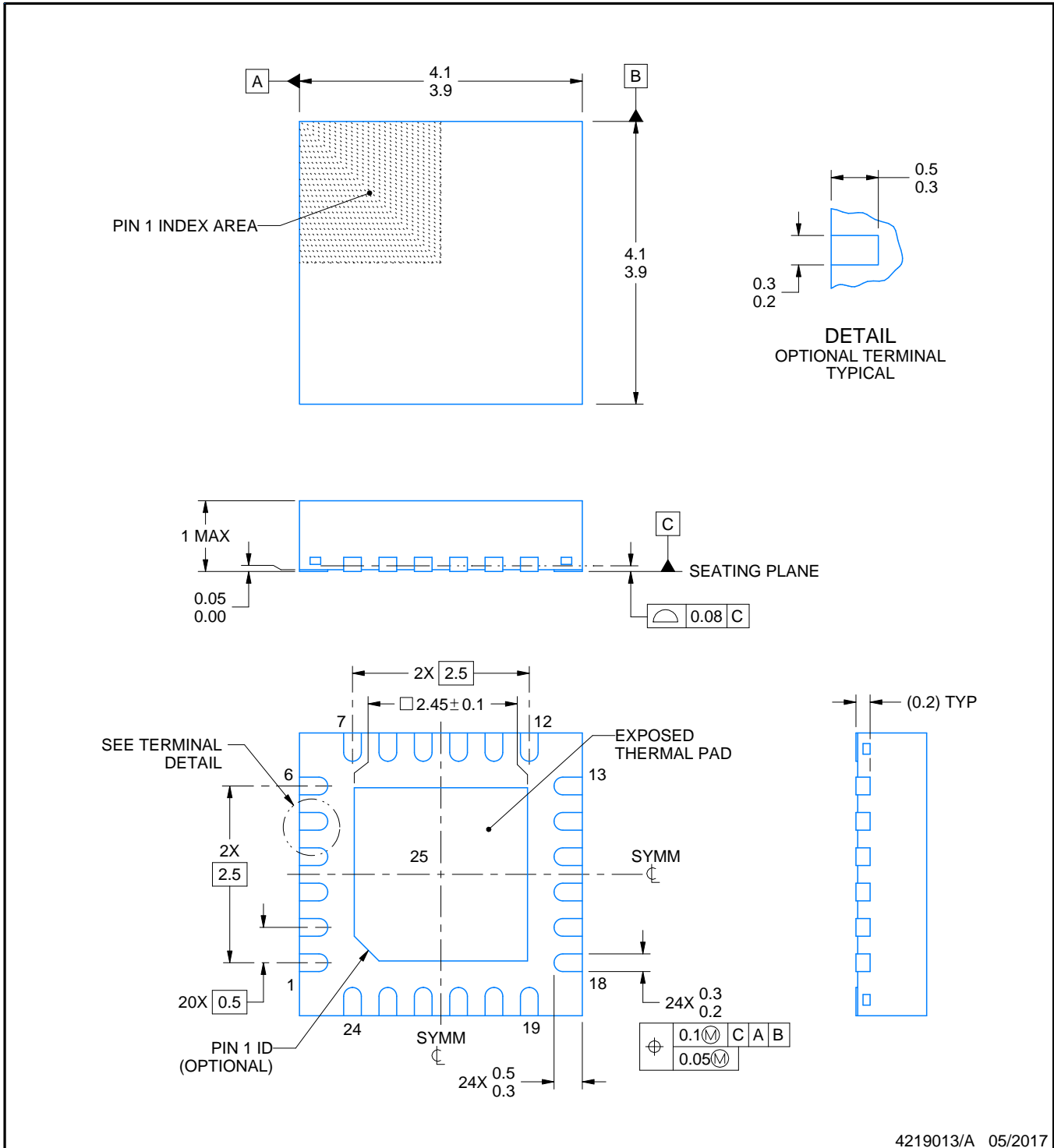

4219013/A 05/2017

NOTES:

1. All linear dimensions are in millimeters. Any dimensions in parenthesis are for reference only. Dimensioning and tolerancing per ASME Y14.5M.
2. This drawing is subject to change without notice.
3. The package thermal pad must be soldered to the printed circuit board for thermal and mechanical performance.

# EXAMPLE BOARD LAYOUT

RGE0024B

VQFN - 1 mm max height

PLASTIC QUAD FLATPACK - NO LEAD

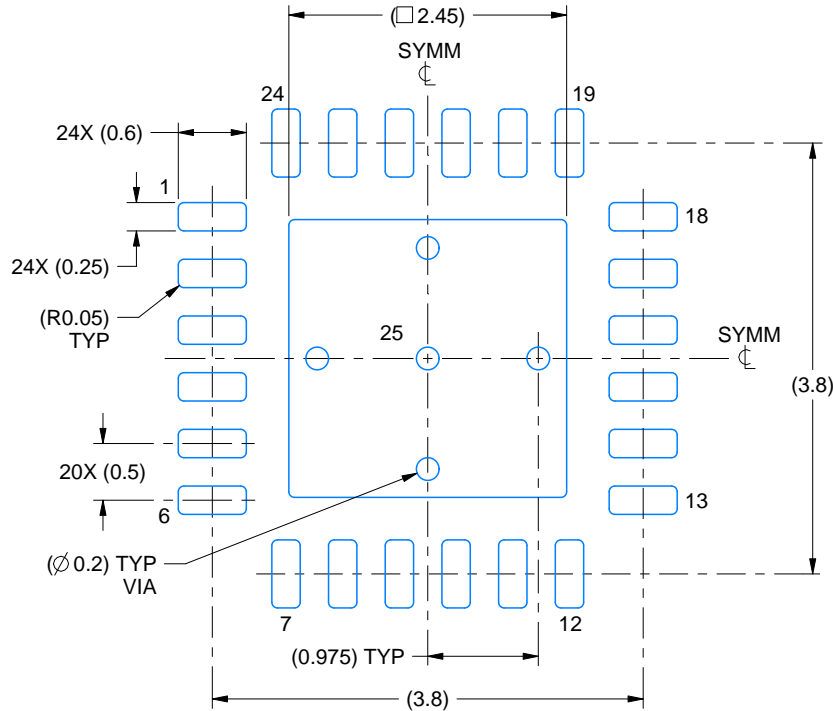

LAND PATTERN EXAMPLE  
EXPOSED METAL SHOWN  
SCALE:15X

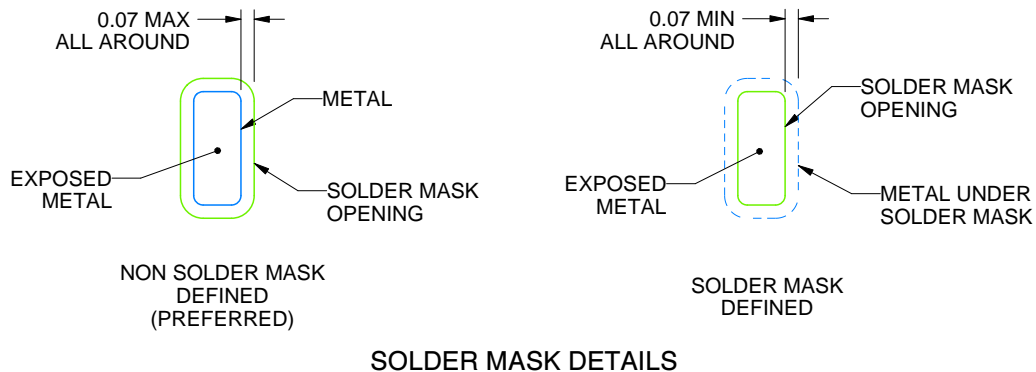

SOLDER MASK DETAILS

4219013/A 05/2017

NOTES: (continued)

- This package is designed to be soldered to a thermal pad on the board. For more information, see Texas Instruments literature number SLUA271 ([www.ti.com/lit/slua271](http://www.ti.com/lit/slua271)).
- Vias are optional depending on application, refer to device data sheet. If any vias are implemented, refer to their locations shown on this view. It is recommended that vias under paste be filled, plugged or tented.

# EXAMPLE STENCIL DESIGN

RGE0024B

VQFN - 1 mm max height

PLASTIC QUAD FLATPACK - NO LEAD

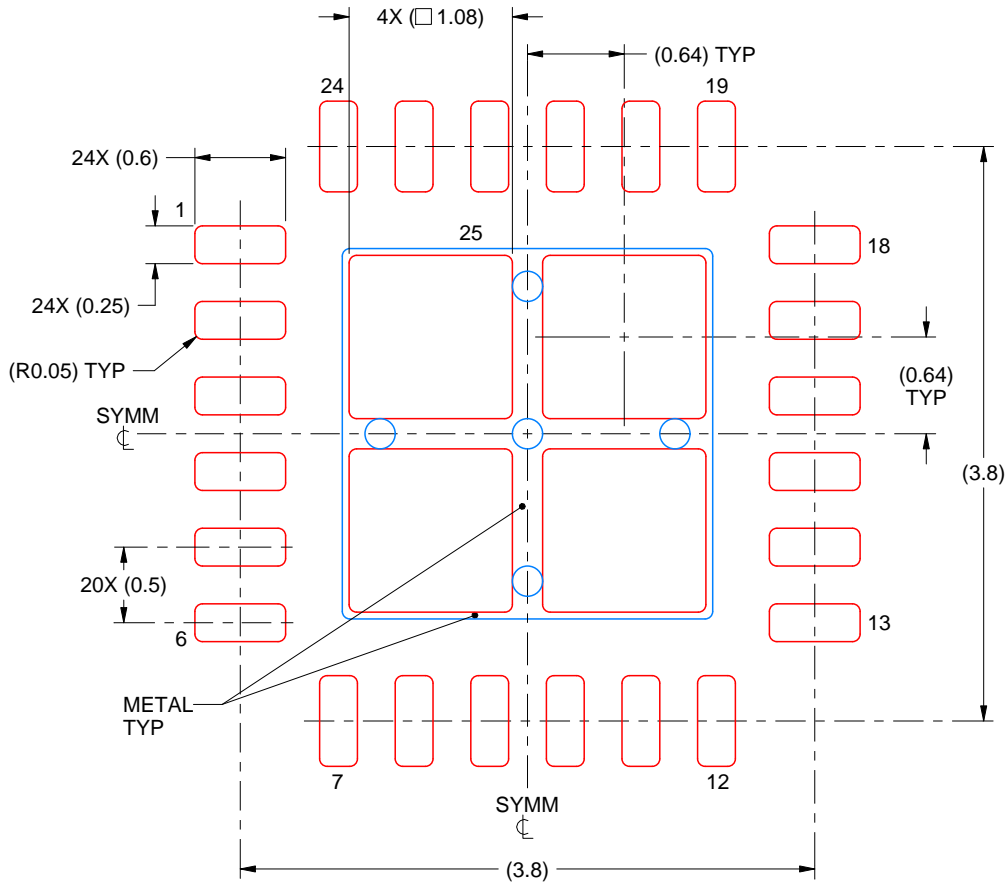

**SOLDER PASTE EXAMPLE**  
 BASED ON 0.125 mm THICK STENCIL

EXPOSED PAD 25  
 78% PRINTED SOLDER COVERAGE BY AREA UNDER PACKAGE  
 SCALE:20X

4219013/A 05/2017

NOTES: (continued)

6. Laser cutting apertures with trapezoidal walls and rounded corners may offer better paste release. IPC-7525 may have alternate design recommendations.



## IMPORTANT NOTICE AND DISCLAIMER

TI PROVIDES TECHNICAL AND RELIABILITY DATA (INCLUDING DATASHEETS), DESIGN RESOURCES (INCLUDING REFERENCE DESIGNS), APPLICATION OR OTHER DESIGN ADVICE, WEB TOOLS, SAFETY INFORMATION, AND OTHER RESOURCES "AS IS" AND WITH ALL FAULTS, AND DISCLAIMS ALL WARRANTIES, EXPRESS AND IMPLIED, INCLUDING WITHOUT LIMITATION ANY IMPLIED WARRANTIES OF MERCHANTABILITY, FITNESS FOR A PARTICULAR PURPOSE OR NON-INFRINGEMENT OF THIRD PARTY INTELLECTUAL PROPERTY RIGHTS.

These resources are intended for skilled developers designing with TI products. You are solely responsible for (1) selecting the appropriate TI products for your application, (2) designing, validating and testing your application, and (3) ensuring your application meets applicable standards, and any other safety, security, or other requirements. These resources are subject to change without notice. TI grants you permission to use these resources only for development of an application that uses the TI products described in the resource. Other reproduction and display of these resources is prohibited. No license is granted to any other TI intellectual property right or to any third party intellectual property right. TI disclaims responsibility for, and you will fully indemnify TI and its representatives against, any claims, damages, costs, losses, and liabilities arising out of your use of these resources.

TI's products are provided subject to TI's Terms of Sale ([www.ti.com/legal/termsofsale.html](http://www.ti.com/legal/termsofsale.html)) or other applicable terms available either on [ti.com](http://ti.com) or provided in conjunction with such TI products. TI's provision of these resources does not expand or otherwise alter TI's applicable warranties or warranty disclaimers for TI products.

Mailing Address: Texas Instruments, Post Office Box 655303, Dallas, Texas 75265  
Copyright © 2020, Texas Instruments Incorporated