

Double Pole, Electrically Held, 1 Amp and Less (Continued)

MGS, MGSD, MGSDD

MGS
Sensitive .100 Grid
High Performance Relay
Qualified to
MIL-R-39016/41



Terminal View

MGSD
Sensitive .100 Grid
Diode Suppressed
High Performance Relay
Qualified to
MIL-R-39016/42

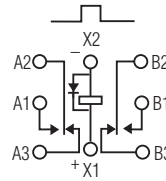

Terminal View

MGSDD
Sensitive .100 Grid Diode
Suppressed/Protected
High Performance Relay
Qualified to
MIL-R-39016/43

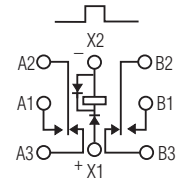

Terminal View

Product Facts

- Hermetically sealed
- High shock & vibration ratings
- Mounting pads
- Excellent RF switching

Product Facts

- Suppression diode
- Hermetically sealed
- High shock & vibration ratings
- Mounting pads
- Excellent RF switching

Product Facts

- Suppression & protection diodes
- Hermetically sealed
- High shock & vibration ratings
- Mounting pads
- Excellent RF switching

Electrical Characteristics

Contact Arrangement — 2 Form C (DPDT)

Contact Material — Stationary — Gold/platinum/palladium/silver (gold plated)
Moveable — Gold/platinum/palladium/silver (gold plated)

Contact Resistance — Before Life — 100 milliohms max. (measured @ 10 mA @ 6 Vdc)
After Life — 200 milliohms max. (measured @ 1 A @ 28 Vdc)

Mechanical Life Expectancy — 1 million operations

Coil Voltage — 5 to 48 Vdc
Coil Power — 565 mW max. @ 25°C
Duty Cycle — Continuous

Pick-up Voltage — Approximately 50% of nominal coil voltage

Pick-up Sensitivity — 60 mW max. @ 25°C

Contact Ratings

Contact Load	Type	Operations Min.
1.0 A @ 28 Vdc	Resistive	100,000
250 mA @ 115 Vac, 60 Hz & 400 Hz	Resistive (case not grounded)	100,000
100 mA @ 115 Vac, 60 Hz & 400 Hz	Resistive	100,000
0.2 A @ 28 Vdc	Inductive (0.32 Henry)	100,000
0.1 A @ 28 Vdc	Lamp	100,000
30 µA @ 50 mVdc	Low Level	1,000,000
0.1 A @ 28 Vdc	Intermediate Current	50,000



MGS

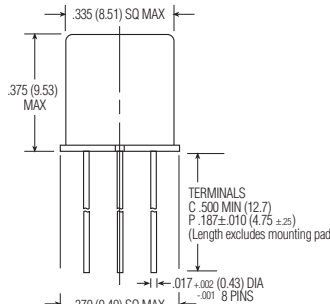

MGS/MGSD/MGSDD Enclosure

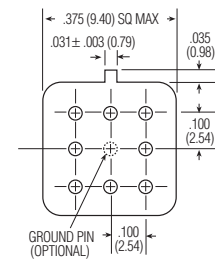

MGS/MGSD/MGSDD Header

Double Pole, Electrically Held, 1 Amp and Less (Continued)

MGS, MGSD, MGSDD
(Continued)

Operating Characteristics

Timing —
 Operate Time — 4.0 ms max.
 Release Time —
 MGS — 2.0 ms max.
 MGSD/MGSDD — 7.5 ms max.
 (suppression diode, protection/
 suppression diodes)
Contact Bounce — 1.5 ms max.
Dielectric Withstanding Voltage —
 Between Open Contacts —
 500 Vrms 60 Hz
 Between Adjacent Contacts —
 500 Vrms 60 Hz
 Between Contacts & Coil —
 500 Vrms 60 Hz
Insulation Resistance —
 10,000 megohms min. @ 500 Vdc
 1,000 megohms @ 500 Vdc
 (coil to case @ +125°C)

Environmental Characteristics

Temperature Range —
 -65°C to +125°C
Weight —
 0.09 oz. (2.55 gms)
 0.129 oz. (3.45 gms) w/ mounting pad
 attached
Vibration Resistance —
 30 G's, 10 to 3,000 Hz
Shock Resistance —
 75 G's, 6 ±1 ms max.
QPL Approval —
 MIL-R-39016/41 (JMGS)
 MIL-R-39016/42 (JMGS)
 MIL-R-39016/43 (JMGSDD)

Semiconductor Characteristics

Diode —
 100 Vdc peak inverse voltage (PIV)
 1.0 Vdc max. transient voltage



MGS/MGSD/MGSDD
Mounting Pad

Coil Data

Nom. Coil Voltage (Vdc)	Coil Resistance in Ohms ±10% @ 25°C (Note)	Coil Circuit Current mA (Max.) (Note)	Coil Circuit Current mA (Min.) (Note)	Pickup Voltage Vdc (Max.) @ 25°C	Pickup Voltage Vdc (Max.) @ 125°C	Drop-Out Voltage Vdc (Min.) @ 25°C	Drop-Out Voltage Vdc (Min.) @ -65°C	Nom. Coil Power (mW) @ 25°C	Max. Coil Voltage	Coil Desig.
MGS/MGSD										
5.0	100	n/a	n/a	2.6	3.5	0.23	0.12	250	7.5	5
6.0	200	n/a	n/a	3.4	4.5	0.28	0.18	180	10.0	6
9.0	400	n/a	n/a	4.85	6.8	0.55	0.35	203	15.0	9
12.0	800	n/a	n/a	7.0	9.0	0.64	0.41	180	20.0	12
18.0	1,600	n/a	n/a	9.8	13.5	0.92	0.59	203	30.0	18
26.5	3,200	n/a	n/a	14.0	18.0	1.4	0.89	219	40.0	26
36.0	6,500	n/a	n/a	20.0	27.0	1.8	1.25	199	57.0	36
48.0	11,000	n/a	n/a	25.8	36.0	2.4	1.60	209	75.0	48
MGSDD										
5.0	64	78.1	56.8	2.9	3.7	0.8	0.7	391	7.5	5
6.0	125	48.9	36.3	4.0	4.8	0.9	0.8	288	10.0	6
9.0	400	23.6	18.1	6.1	8.0	1.1	0.9	203	15.0	9
12.0	800	16.0	12.5	7.8	11.0	1.3	1.0	180	20.0	12
18.0	1,600	12.2	9.6	11.3	14.5	1.5	1.1	203	30.0	18
26.5	3,200	9.0	7.2	15.2	19.0	1.7	1.3	219	40.0	26
36.0	6,500	6.1	4.9	21.7	27.2	2.3	1.7	199	57.0	36
48.0	11,000	4.8	3.9	27.8	34.8	2.8	2.0	209	75.0	48

Note: Coil resistance not directly measurable. Coil current should be within limits shown when tested at nominal voltage at 25°C for 5 seconds max.

Ordering Instructions

Catalog-selected Relays: The catalog number is derived by choosing the proper CODE for each of the relay characteristics in the order in which the codes are listed.

Specifying a Part Number Example:	Type	Terminals	Diodes	Ground Pins	Coils	Mounting Pads
	MGS	C	D	G	-26	W

* The part number example shown on this page is for catalog items. For a list of specific QPL part numbers, please see the index in Section 15.

Mouser Electronics

Authorized Distributor

Click to View Pricing, Inventory, Delivery & Lifecycle Information:

[TE Connectivity:](#)

[JMGSCD-26MW](#)