

Ordering Information

Part Number		Temperature Range	Package
Standard	Pb-Free		
MIC38C42ABM	MIC38C42AYM	-40°C to +85°C	8-pin SOIC
MIC38C43ABM	MIC38C43AYM	-40°C to +85°C	8-pin SOIC
MIC38C44ABM	MIC38C44AYM	-40°C to +85°C	8-pin SOIC
MIC38C45ABM	MIC38C45AYM	-40°C to +85°C	8-pin SOIC
MIC38C42ABMM	MIC38C42AYMM	-40°C to +85°C	8-pin MM8™
MIC38C43ABMM	MIC38C43AYMM	-40°C to +85°C	8-pin MM8™
MIC38C44ABMM	MIC38C44AYMM	-40°C to +85°C	8-pin MM8™
MIC38C45ABMM	MIC38C45AYMM	-40°C to +85°C	8-pin MM8™

Refer to the Part Number Cross Reference for a listings of Micrel devices equivalent to UC284x and UC384x devices.

Selection Guide

Duty Cycle	UVLO Thresholds	
	Startup 8.4V Minimum Operating 7.6V	Startup 14.5V Minimum Operating 9V
0% to 96%	MIC38C43A	MIC38C42A
0% to 50%	MIC38C45A	MIC38C44A

Pin Configuration

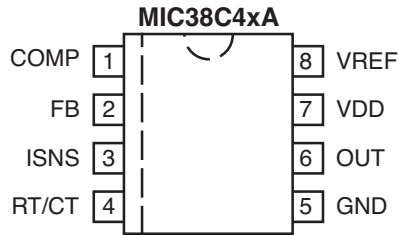

8-Lead SOIC (M)
8-Lead MM8™ (MM)

Pin Description

Pin Number	Pin Name	Pin Function
1	COMP	Compensation: Connect external compensation network to modify the error amplifier output.
2	FB	Feedback (Input): Error amplifier input. Feedback is 2.5V at desired output voltage.
3	ISNS	Current Sense (Input): Current sense comparator input. Connect to current sensing resistor or current transformer.
4	RT/CT	Timing Resistor/Timing Capacitor: Connect external RC network to select switching frequency.
5	GND	Ground: Combined analog and power ground.
6	OUT	Power Output: Totem-pole output.
7	VDD	Analog Supply (Input): Controller circuitry supply input. Return to analog ground (AGND).
8	VREF	5V Reference (Output): Connect external RC network.

Absolute Maximum Ratings

Supply Voltage (V_{DD})	20V
Switch Supply Voltage (V_D)	20V
Current Sense Voltage (V_{ISNS})	-0.3V to 5.5V
Feedback Voltage (V_{FB})	-0.3V to 5.5V
Output Current (I_{OUT})	0.5A
Storage Temperature (T_A)	-65°C to +150°C

Operating Ratings

Junction Temperature (T_J)	150°C
Package Thermal Resistance	
8-Pin MM8™ (θ_{JA})	250°C/W
8-Pin SOIC (θ_{JA})	170°C/W

Electrical Characteristics(Note 6)

$V_{DD} = 15V$, **Note 4**; $R_T = 11.0k$; $C_T = 3.3nF$; $-40^\circ C \leq T_A \leq 85^\circ C$; unless noted

Parameter	Test Conditions	Min	Typ	Max	Units
-----------	-----------------	-----	-----	-----	-------

Reference Section

Output Voltage	$T_A = 25^\circ C$, $I_O = 1mA$	4.90	5.00	5.10	V
Line Regulation	$12V \leq V_{DD} \leq 18V$, $I_O = 5\mu A$		2	20	mV
Load Regulation	$1 \leq I_O \leq 20mA$		1	25	mV
Temp. Stability	Note 1		0.2		mV/°C
Total Output Variation	Line, Load, Temp., Note 1	4.82		5.18	V
Output Noise Voltage	$10Hz \leq f \leq 10kHz$, $T_A = 25^\circ C$, Note 1		50		μV
Long Term Stability	$T_A = 125^\circ C$, 1000 hrs., Note 1		5	25	mV
Output Short Circuit		-30	-80	-180	mA

Oscillator Section

Initial Accuracy	$T_A = 25^\circ C$, Note 5	47	53	59	kHz
Voltage Stability	$12 \leq V_{DD} \leq 18V$		0.2	1.0	%
Temp. Stability	$T_{MIN} \leq T_A \leq T_{MAX}$, Note 1		0.04		%/°C
Clock Ramp Reset Current	$T_A = 25^\circ C$, $V_{RT/CT} = 2V$, Note 1	7.7	8.4	9.0	mA
Amplitude	$V_{RT/CT}$ peak to peak		1.9		Vp-p

Error Amp Section

Input Voltage	$V_{COMP} = 2.5V$	2.4	2.50	2.58	V
Input Bias Current	$V_{FB} = 5.0V$		-0.1	-2	μA
A_{VOL}	$2 \leq V_O \leq 4V$	65	90		dB
Unity Gain Bandwidth	Note 1	0.7	1.0		MHz
PSRR	$12 \leq V_{DD} \leq 18V$	60			dB
Output Sink Current	$V_{FB} = 2.7V$, $V_{COMP} = 1.1V$	2	14		mA
Output Source Current	$V_{FB} = 2.3V$, $V_{COMP} = 5V$	-0.3	-1		mA
V_{OUT} High	$V_{FB} = 2.3V$, $R_L = 15k$ to ground	5	6.8		V
V_{OUT} Low	$V_{FB} = 2.7V$, $R_L = 15k$ to V_{REF}		0.1	1.1	V

Parameter	Test Conditions	Min	Typ	Max	Units
Current Sense					
Gain	Notes 2, 3	2.85	3.0	3.15	V/V
Maximum Threshold	$V_{COMP} = 5V$, Note 2	0.9	1	1.1	V
PSRR	$12 \leq V_{DD} \leq 18V$, Note 2		70		dB
Input Bias Current			-0.1	-2	μA
Delay to Output			120	250	ns

Output

$R_{DS(ON)}$ High	$I_{SOURCE} = 200mA$		20		Ω
$R_{DS(ON)}$ Low	$I_{SINK} = 200mA$		11		Ω
Rise Time	$T_A = 25^\circ C$, $C_L = 1nF$		40	80	ns
Fall Time	$T_A = 25^\circ C$, $C_L = 1nF$		30	60	ns

Undervoltage Lockout

Start Threshold	MIC38C42A/4A	13.5	14.5	15.5	V
	MIC38C43A/5A	7.8	8.4	9.0	V
Minimum Operating Voltage	MIC38C42A/4A	8	9	10	V
	MIC38C43A/5A	7.0	7.6	8.2	V

Pulse Width Modulator

Maximum Duty Cycle	MIC38C42A/3A	94	96		%
	MIC38C44A/5A	46	50		%
Minimum Duty Cycle				0	%

Total Standby Current

Start-Up Current	$V_{DD} = 13V$ for MIC38C42A/44A $V_{DD} = 7.5V$ for MIC38C43A/45A		100	230	μA
Operating Supply Current	$V_{FB} = V_{ISNS} = 0V$		4.0	6.0	mA

Note 1: These parameters, although guaranteed, are not 100% tested in production.

Note 2: Parameter measured at trip point of latch with $V_{EA} = 0$.

Note 3: Gain defined as:

$$A = \frac{\Delta V_{PIN1}}{V_{TH}(I_{SNS})}; 0 \leq V_{TH}(I_{SNS}) \leq 0.8V$$

Note 4: Adjust V_{DD} above the start threshold before setting at 15V.

Note 5: Output frequency equals oscillator frequency for the MIC38C42 and MIC38C43. Output frequency for the MIC38C44A, and MIC38C45A equals one half the oscillator frequency.

Note 6: Specification for packaged product only.

Typical Characteristics

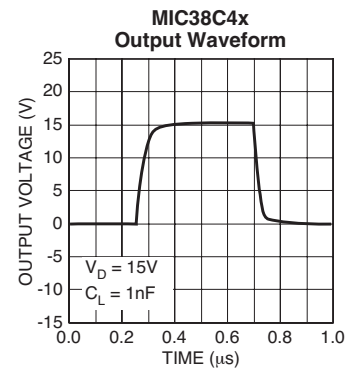
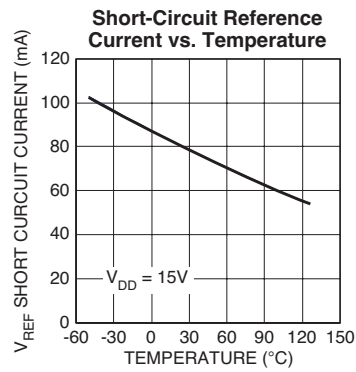
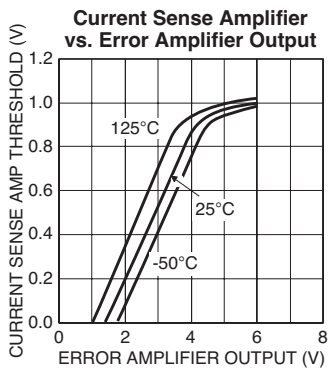
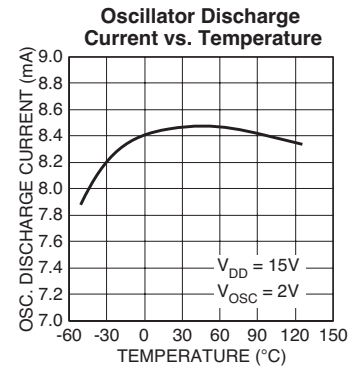
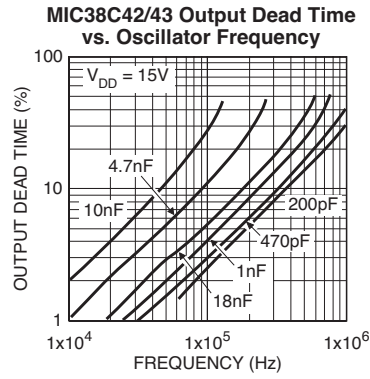
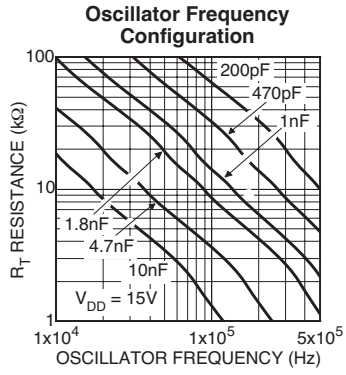

Application Information

Familiarity with 384x converter designs is assumed.

MIC38C4x Advantages

Start-up Current

Start-up current has been reduced to an ultra-low 50 μ A (typical) permitting higher-valued, lower-wattage, start-up resistors (powers controller during power supply start-up). The reduced resistor wattage reduces cost and printed circuit space.

Operating Current

Operating current has been reduced to 4mA compared to 11mA for a typical bipolar controller. The controller runs cooler and the V_{DD} hold-up capacitance required during start-up may be reduced.

Output Driver

Complementary internal P- and N-channel MOSFETs produce rail-to-rail output voltages for better performance driving external power MOSFETs. The driver transistor's low on-resistance and high peak current capability can drive gate capacitances of greater than 1000pF. The value of output capacitance which can be driven is determined only by the rise/fall time requirements. Within the restrictions of output capacity and controller power dissipation, maximum switching frequency can approach 500kHz.

Design Precautions

When operating near 20V, circuit transients can easily exceed the 20V absolute maximum rating, permanently damaging the controller's CMOS construction. To reduce transients, use a 0.1 μ F low-ESR capacitor to next to the controller's supply V_{DD} (or V_D for '-1' versions) and ground connections. Film type capacitors, such as Wima MKS2, are recom-

mended.

When designing high-frequency converters, avoid capacitive and inductive coupling of the switching waveform into high-impedance circuitry such as the error amplifier, oscillator, and current sense amplifier. Avoid long printed-circuit traces and component leads. Locate oscillator and compensation circuitry near the IC. Use high frequency decoupling capacitors on V_{REF} , and if necessary, on V_{DD} . Return high di/dt currents directly to their source and use large area ground planes.

Buck Converter

Refer to figure 1. When at least 26V is applied to the input, C5 is charged through R2 until the voltage V_{DD} is greater than 14.5V (the undervoltage lockout value of the MIC38C42). Output switching begins when Q1 is turned on by the gate drive transformer T1, charging the output filter capacitor C3 through L1. D5 supplies a regulated +12V to V_{DD} once the circuit is running.

Current sense transformer CT1 provides current feedback to ISNS for current-mode operation and cycle-by-cycle current limiting. This is more efficient than a high-power sense resistor and provides the required ground-referenced level shift.

When Q1 turns off, current flow continues from ground through D1 and L1 until Q1 is turned on again.

The 100V Schottky diode D1 reduces the forward voltage drop in the main current path, resulting in higher efficiency than could be accomplished using an ultra-fast-recovery diode. R1 and C2 suppress parasitic oscillations from D1.

Using a high-value inductance for L1 and a low-ESR capacitor for C3 permits small capacitance with minimum output ripple. This inductance value also improves circuit efficiency by reducing the flux swing in L1.

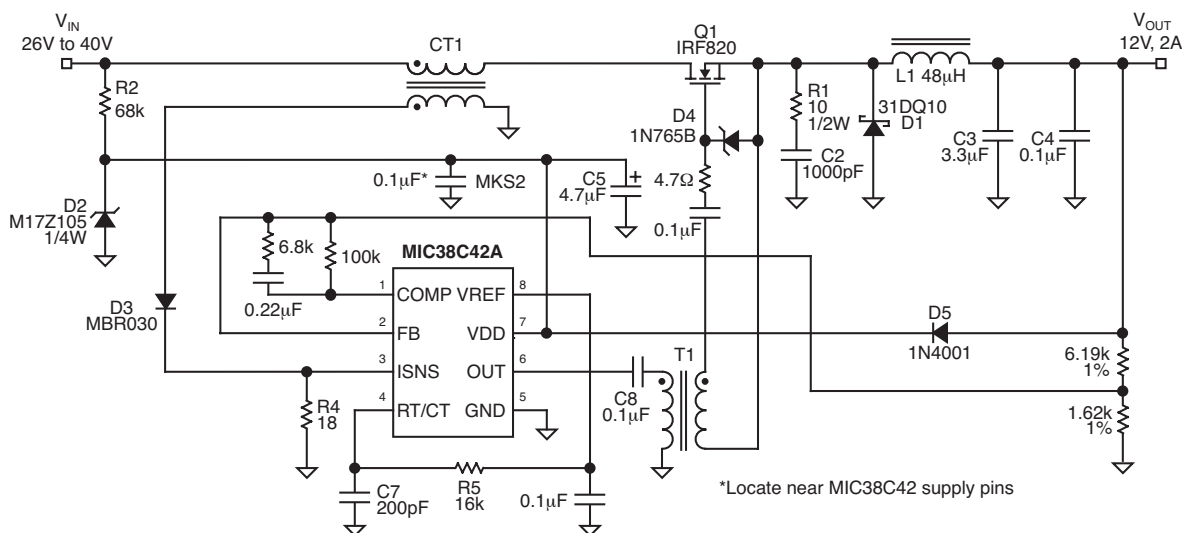
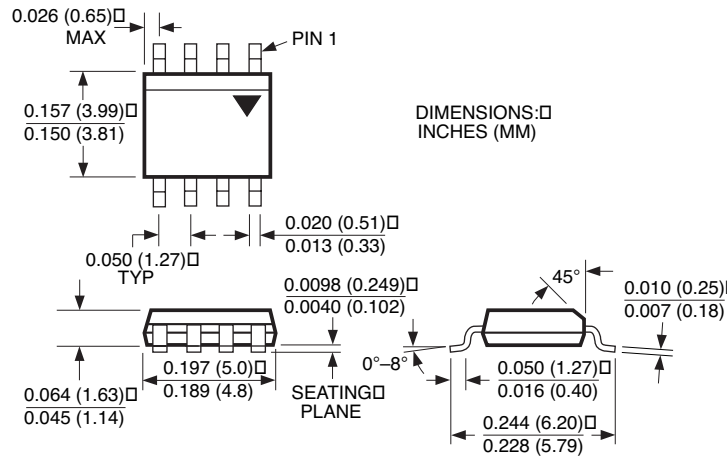
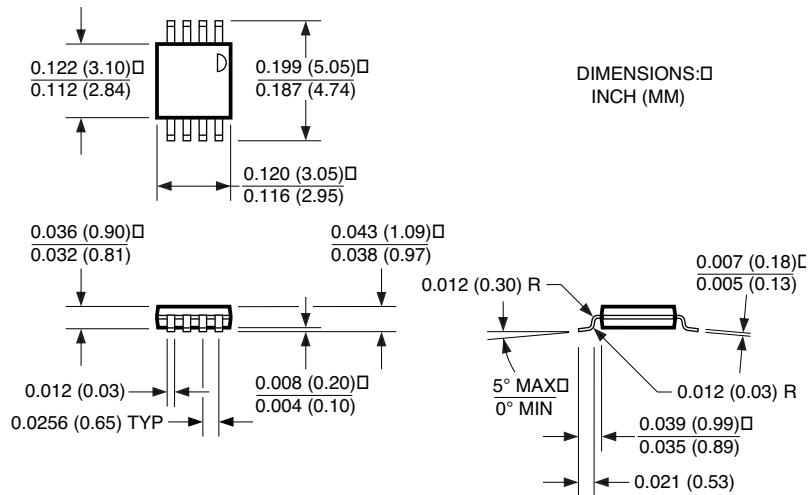

Figure 1. 500kHz, 25W, Buck Converter

Package Information



8-Pin SOP (M)



8-Pin MSOP (MM)

MICREL INC. 2180 FORTUNE DRIVE SAN JOSE, CA 95131 USA

TEL + 1 (408) 944-0800 FAX + 1 (408) 474-1000 WEB <http://www.micrel.com>

This information furnished by Micrel in this data sheet is believed to be accurate and reliable. However no responsibility is assumed by Micrel for its use. Micrel reserves the right to change circuitry and specifications at any time without notification to the customer.

Micrel Products are not designed or authorized for use as components in life support appliances, devices or systems where malfunction of a product can reasonably be expected to result in personal injury. Life support devices or systems are devices or systems that (a) are intended for surgical implant into the body or (b) support or sustain life, and whose failure to perform can be reasonably expected to result in a significant injury to the user. A Purchaser's use or sale of Micrel Products for use in life support appliances, devices or systems is a Purchaser's own risk and Purchaser agrees to fully indemnify Micrel for any damages resulting from such use or sale.

© 2002 Micrel Incorporated

Mouser Electronics

Authorized Distributor

Click to View Pricing, Inventory, Delivery & Lifecycle Information:

Micrel:

[MIC38C42AYMM TR](#) [MIC38C43AYM TR](#) [MIC38C43AYMM TR](#) [MIC38C44AYM TR](#) [MIC38C45AYMM TR](#)

Microchip:

[MIC38C42AYM](#) [MIC38C42AYMM](#) [MIC38C43AYM](#) [MIC38C43AYMM](#) [MIC38C44AYM](#) [MIC38C44AYMM](#)
[MIC38C45AYM](#) [MIC38C45AYMM](#) [MIC38C42AYMM-TR](#) [MIC38C45AYM-TR](#) [MIC38C43AYM-TR](#) [MIC38C43AYMM-](#)
[TR](#) [MIC38C45AYMM-TR](#) [MIC38C42AYM-TR](#) [MIC38C44AYMM-TR](#) [MIC38C44AYM-TR](#)