

## OSP Miniature Modular Blind Mate Connectors

### Product Facts

- Interface designed for multiple interconnects
- For high performance microwave system requirements
- Module to module, module to motherboard, fixed and float mount
- Bulkhead or panel mount
- For flexible and semi-rigid cable



OSP miniature connectors for semi-rigid cable meet high performance requirements for microwave multiple interconnects. Standard units are available in bulkhead or panel mount designs for either direct solder or solderless compression crimp attachment. Complete tooling for both versions is located in the Tooling Section of this catalog.

Jack connectors are available in either float or rigid mount. Rigid mount units will function to specifications up to  $\pm .10$  [.004] radial misalignment with the mating plug connector. Applications requiring greater than  $\pm .10$  [.004] radial misalignment can use either the float design or floating connector plates with guide pins.

The solderless compression crimp attachment meets

high performance requirements for microwave system applications. The cable attachment is permanent and highly reliable.

Ease of assembly permits users unskilled in soldering techniques to rapidly produce cable assemblies with consistently excellent mechanical and electrical performance.

**OSP Miniature Modular Blind Mate Connectors (Continued)**

The specifications given refer specifically to mated pair of Part Numbers 1059410-1 and 1059402-1 (RG 402) and 1059412-1 and 1059404-1 (RG 405). Specifications on other connectors are available on request.

The general electrical, mechanical and environmental specifications in the following table are recommended for procurement documents or drawings.

**Engineering Data**

Impedance —	50 ohms
Frequency —	dc to 22.0 GHz
Temperature Rating —	-65° to 125° C

**Electrical**

	<b>RG 402 (.141) Semi-Rigid</b>	<b>RG 405 (.085) Semi-Rigid</b>
VSWR —		
dc - 18.0 GHz	1.02 + .005f (GHz)	1.05 + .005f (GHz)
18.0 - 22.0 GHz	1.02 + .008f (GHz)	1.05 + .009f (GHz)
RF Transmission Loss —	.03 x $\sqrt{f}$ (GHz)	.03 x $\sqrt{f}$ (GHz)
Insulation Resistance —	5,000 megohms min.	5,000 megohms min.
Contact Resistance —		
Center Contact	2.0 milliohms max.	2.0 milliohms max.
Outer Contact	2.0 milliohms max.	2.0 milliohms max.
Outer Contact to Cable	0.5 milliohms max.	0.5 milliohms max.
Dielectric Withstanding Voltage —	1500 volts RMS	1000 volts RMS
Corona Extinction Voltage at 70,000 Ft.—	375 volts min.	335 volts min.
RF High Potential at 5 MHz —	1,000 volts RMS	670 volts RMS
RF Leakage Interface Only —	-(90-fGHz) dB min. (fully mated)	-(90-fGHz) dB min. (fully mated)
Power Handling —	300W at 3 GHz (sea level) and room temperature	

**Environmental**

Corrosion —	Method 101, Condition B, MIL-STD-202
Vibration —	Method 204, Condition D, 20G's, MIL-STD-202
Shock —	Method 213, Condition I, 100G's, MIL-STD-202
Temperature Cycling —	Method 107, Condition B, MIL-STD-202
Moisture Resistance —	Method 106, MIL-STD-202

**Material**

Housing —	Corrosion resistant steel Type 303 (stainless) per ASTM A484 and A582
Center Contact —	Beryllium copper per ASTM-B-196
Dielectric —	TFE fluorocarbon per ASTM-D-1457
Gasket (O'Ring) —	MIL-P-25732

**Mechanical**

Force to Engage —	3 pounds max.
Force to Disengage —	1.5 pounds max.
Center Contact Retention —	6 pounds min.
Durability —	5,000 Cycles
Radial Misalignment —	
Rigid Mount	±.10 [±.004]
Float Mount	±.51 [±.020]

**Mating Characteristics**

Jack Connector —		
Center Contact Socket	Oversize test Pin —	.945 + .003 [.0372 + .0001] dia.
	Test Pin Finish —	16 micro inch
	Insertion Depth —	.76/1.14 [.030/.045]
	Number of Insertions —	3
Insertion Force	Test Pin —	.940 + .003 [.0370 + .0001] dia.
	Test Pin Finish —	16 micro inch
	Insertion Depth —	1.27/1.91 [.050/.075]
	Insertion Force —	3 pounds max.
Withdrawal Force	Test Pin —	.90 + .003 [.0355 - .0001] dia.
	Test Pin Finish —	16 micro inch
	Insertion Depth —	1.27/1.91 [.050/.075]
	Withdrawal —	1 ounce min.

**Finish**

Center Contact —	Gold plate per MIL-G-45204, Type II, Class 1 over copper plate per MIL-C-14550
Housing —	Gold plate per MIL-G-45204, Typ II, Class 0 over nickel plate per QQ-N-290, Class 2 or passivate per ASTM-A380

**All dimensions shown are nominal. Contact the factory for specific tolerances.**

**OSP Miniature Modular Blind Mate Connectors (Continued)**  
**Interface Mating Dimensions**

The connector interface, specifically designed for multiple interconnects, maintains reliable performance over the typical mechanical tolerance required in cost effective packaging.

The interface test data shows excellent performance is maintained with mating gaps up to 0.38 [.015].

Meets MIL-STD-348 Figure 321. Intermateable to BMA Connectors.

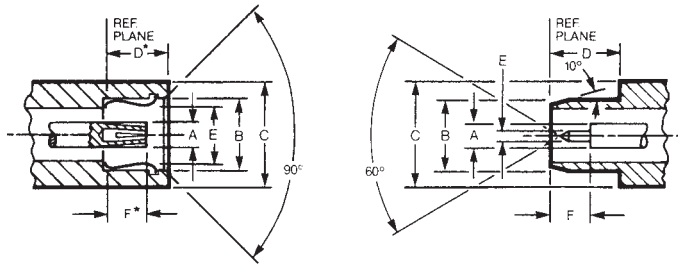

**Jack**

**Plug**

Letter	Dimensions
A	1.78 .070 Nom.
B	5.72 .225 Min.
C	7.62 .300 Ref.
D	5.00 .197 Nom.*
E	5.08 .200 Max.
F	3.23 .127 Max.*

Letter	Dimensions
A	1.78 .070 Nom.
B	5.33 .210 Nom.
C	7.62 .300 Ref.
D	5.05 .199 Min.
E	0.91 .036 Nom.
F	3.25 .128 Min.

\*With spring bottomed

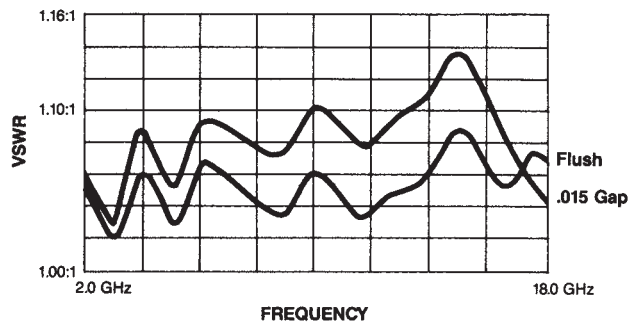

**OSP Miniature Modular Blind Mate Connectors (Continued)**  
**For Semi-Rigid Cable, Direct Solder Attachment**

**Bulkhead Feedthrough Cable Plug Rear Mount**

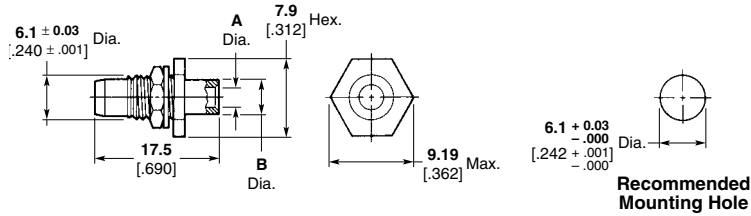

Cable	Plating	Dimensions		Part No.
		A	B	
RG 402/U 3.58 .141	Gold	3.7 .144	4.6 .180	1059402-1
RG 405/U 2.16 .085	Gold	2.3 .089	3.0 .120	1059404-1

**Bulkhead Feedthrough Cable Jack Rigid Rear Mount**

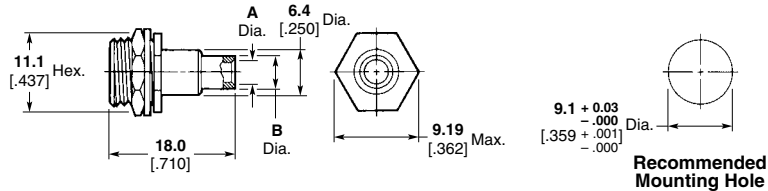

Cable	Plating	Dimensions		Part No.
		A	B	
RG 402/U 3.58 .141	Gold	3.7 .144	4.6 .180	1059410-1
RG 405/U 2.16 .085	Gold	2.3 .089	3.0 .120	1059412-1

**Flange Mount Cable Jack Floating Rear Mount**

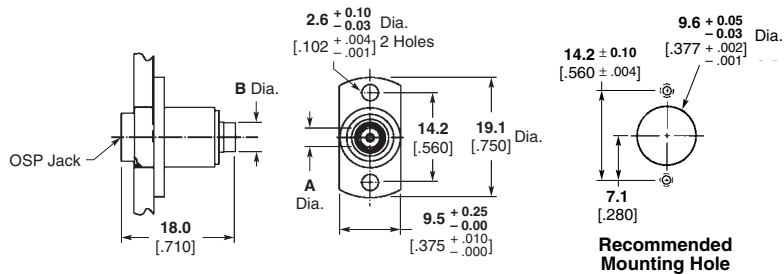

Cable	Dimensions		Part No.
	A	B	
RG 402/U 3.58 .141	3.7 .144	4.6 .180	1059453-1
RG 405/U 2.16 .085	2.3 .089	3.0 .120	1059456-1

Finish: Inner housing that is soldered to cable is gold plated. Outer housing is passivated stainless steel.  
 When using semi-rigid cable, it is recommended that a service loop be used to facilitate the float features of the connector.

**Note:** Part Numbers are RoHS compliant except: ♦ Indicates non-RoHS compliant.

**OSP Miniature Modular Blind Mate Connectors (Continued)**  
**For Semi-Rigid Cable, Direct Solder Attachment (Continued)**

**Low Profile — Bulkhead Feedthrough Cable Jack — Floating Rear Mount**

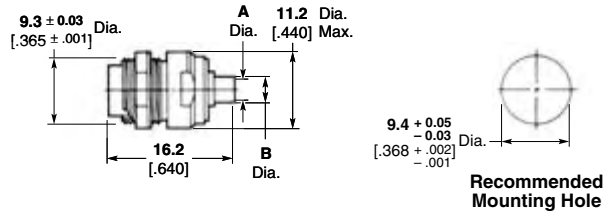

Cable	Plating	Dimensions		Part No.
		A	B	
RG 402/U 3.58 .141	Gold	3.7 .144	4.6 .180	1059505-1
RG 405/U 2.16 .085	Gold	2.3 .089	3.0 .120	1059506-1

When using semi-rigid cable, it is recommended that a service loop be used to facilitate the float features of the connector.

**Low Profile — Panel Feedthrough Cable Jack — Floating Rear Mount**

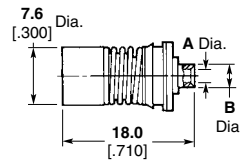

Cable	Plating	Dimensions		Part No.
		A	B	
RG 402/U 3.58 .141	Gold	3.7 .144	4.6 .180	1059465-1
RG 405/U 2.16 .085	Gold	2.3 .089	3.0 .120	1059467-1

Recommended removal tool part number 1059774-1 is described in the Tooling Section of this catalog.  
 When using semi-rigid cable, it is recommended that a service loop be used to facilitate the float features of the connector.

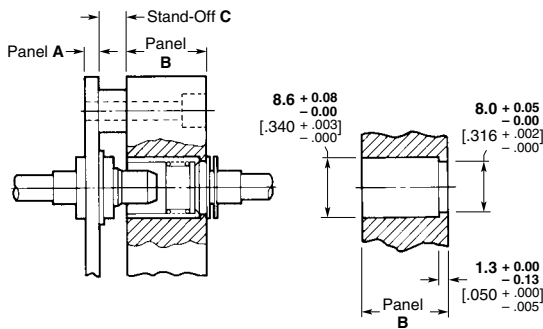

**Recommended Mounting Detail**

Panel A ±.003	Panel B ±.003	Stand-Off Panel C +.050/-0.000
2.3 .090	9.5 .375	7.2 .285
2.3 .090	11.1 .438	5.6 .222
2.3 .090	12.7 .500	4.1 .160
3.2 .125	9.5 .375	6.4 .250
3.2 .125	11.1 .438	4.7 .187
3.2 .125	12.7 .500	3.2 .125

**Note:** Part Numbers are RoHS compliant except: ♦ Indicates non-RoHS compliant.

**OSP Miniature Modular Blind Mate Connectors (Continued)**  
**For Semi-Rigid Cable, Solderless Compression Crimp Attachment**

**Bulkhead Feedthrough Cable Plug Fixed Rear Mount**

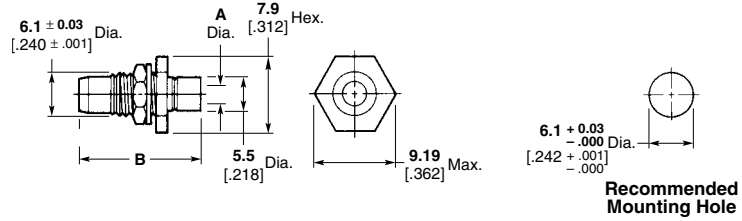

Cable	Plating	Dim. A	Dim. B		Part No.
			Before Crimping	After Crimping	
RG 405/U <b>2.16</b> .085	Passivated Stainless Steel	<b>2.2</b> .088	<b>19.8</b> .782	<b>17.2</b> .677	<b>1059399-1</b>

Outline drawing shows after crimp dimensions.

**Bulkhead Feedthrough Cable Jack Fixed Rear Mount**

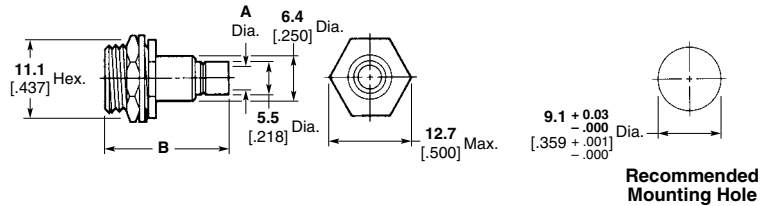

Cable	Plating	Dim. A	Dim. B		Part No.
			Before Crimping	After Crimping	
RG 402/U <b>3.58</b> .141	Passivated Stainless Steel	<b>3.6</b> .143	<b>21.1</b> .830	<b>18.2</b> .715	<b>1059408-1</b>

Outline drawing shows after crimp dimensions.

**Flange Mount Cable Jack Floating Rear Mount**

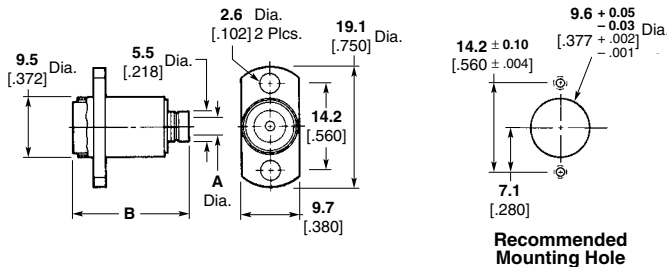

Cable	Plating	Dim. A	Dim. B		Part No.
			Before Crimping	After Crimping	
RG 402/U <b>3.58</b> .141	Passivated Stainless Steel	<b>3.6</b> .143	<b>22.6</b> .891	<b>19.8</b> .780	<b>1059451-1</b>
RG 405/U <b>2.16</b> .085	Passivated Stainless Steel	<b>2.2</b> .088	<b>22.6</b> .891	<b>19.8</b> .780	<b>1059452-1</b>

Outline drawing shows after crimp dimensions.

When using semi-rigid cable, it is recommended that a service loop be used to facilitate the float features of the connector.

**Note:** Part Numbers are RoHS compliant except: ♦ Indicates non-RoHS compliant.

**OSP Miniature Modular Blind Mate Connectors (Continued)**  
**For Flexible Cable, Crimp Attachment**

**Bulkhead Feedthrough Cable Plug Rear Mount**

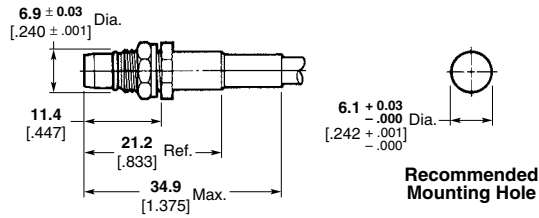

Cable	Plating	Part No.
RG 174/U, 179, 187, 188, 316	Passivated Stainless Steel	1059523-1

**Bulkhead Feedthrough Cable Jack Rigid Rear Mount**

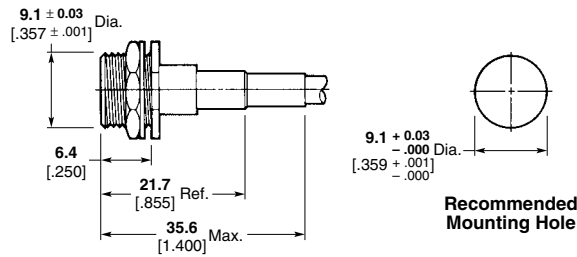

Cable	Plating	Part No.
RG 55/U, 142, 223, 400	Passivated Stainless Steel	1059525-1

**Flange Mount Cable Jack Floating Rear Mount**

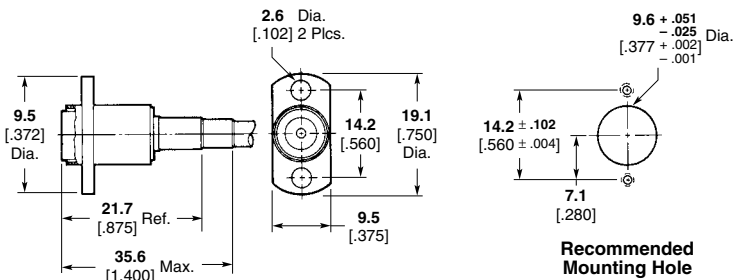

Cable	Plating	Part No.
RG 55/U, 142, 223, 400	Passivated Stainless Steel	1059540-1
RG 174/U, 179, 187, 188, 316	Passivated Stainless Steel	1059541-1
RG 178, Double Braid	Passivated Stainless Steel	1058572-1

**Low Profile — Panel Feedthrough Cable Jack — Rear Mount**

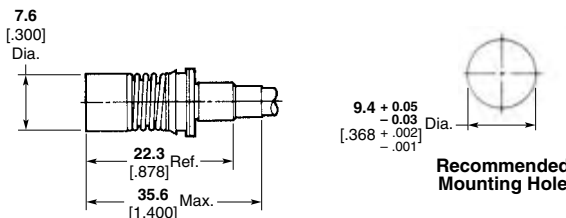

Cable	Plating	Part No.
RG 174/U, 179, 187, 188, 316	Passivated Stainless Steel	1059551-1

Refer to Recommended Mounting Hole Detail for Semi-Rigid Cable Low Profile Feedthrough Cable Jack. Recommended removal tool part number 1059774-1 as described in the Tooling Section of this catalog.

**Note:** Part Numbers are RoHS compliant except: ♦ Indicates non-RoHS compliant.

**OSP Miniature Modular Blind Mate Connectors (Continued)**  
**Panel Mount**

**Straight Terminal**  
**2-Hole Flange Mount Plug**  
**Receptacle**

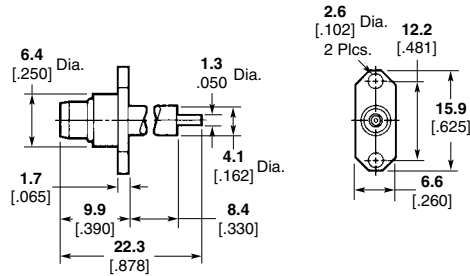

Plating	Part No.
Passivated Stainless Steel	1059566-1

**2-Hole Flange Mount Jack**  
**Receptacle**

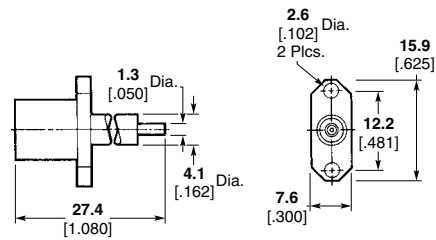

Plating	Part No.
Passivated Stainless Steel	1059596-1

**4-Hole Flange Mount Plug**  
**Receptacle**

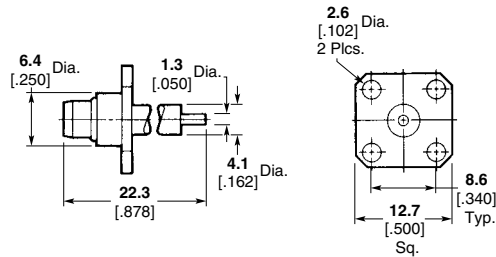

Plating	Part No.
Passivated Stainless Steel	1059563-1

**4-Hole Flange Mount Jack**  
**Receptacle**

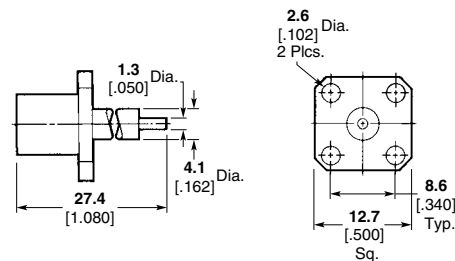

Plating	Part No.
Passivated Stainless Steel	1059594-1

**Note:** Part Numbers are RoHS compliant except: ♦ Indicates non-RoHS compliant.



**OSP Miniature Modular Blind Mate Connectors (Continued)**  
**Panel Mount (Continued)**

**Straight Terminal**  
**Threaded Installation —**  
**Panel Feedthrough Plug**  
**Receptacle**

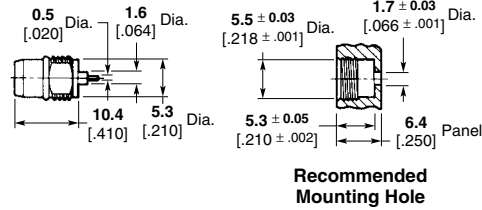

Plating	Part No.
Passivated Stainless Steel	1059617-1

**Threaded Installation —**  
**Panel Feedthrough Jack**  
**Receptacle**

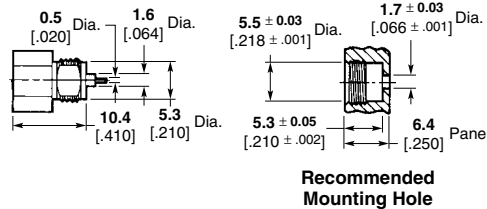

Plating	Part No.
Passivated Stainless Steel	1059657-1

**Press Fit Installation —**  
**Panel Feedthrough Plug**  
**Receptacle**

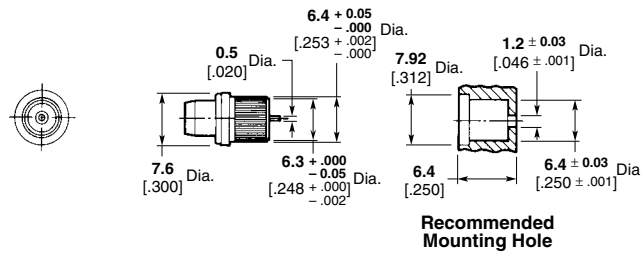

Plating	Part No.
Passivated Stainless Steel	1059651-1

**Press Fit Installation —**  
**Panel Feedthrough Jack**  
**Receptacle**

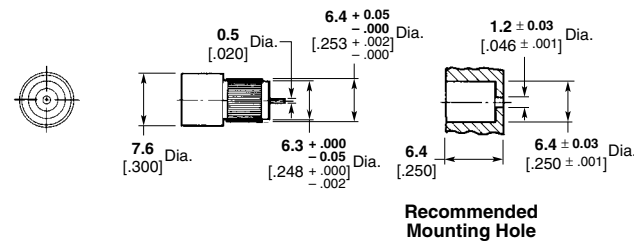

Plating	Part No.
Passivated Stainless Steel	1059654-1

**Note:** Part Numbers are RoHS compliant except: ♦ Indicates non-RoHS compliant.

**OSP Miniature Modular Blind Mate Connectors (Continued)**  
**Printed Circuit Board Mount**

**Straight Plug Receptacle —  
Captured Contact**

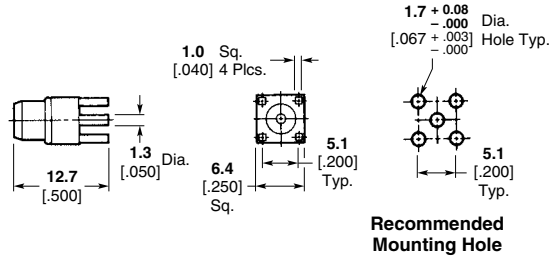

Plating	Part No.
Gold	1059684-1

**Straight Jack Receptacle —  
Captured Contact**

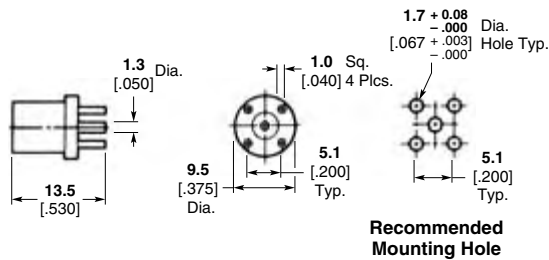

Plating	Part No.
Gold	1059681-1

**Right-Angle Plug Receptacle —  
Captured Contact**

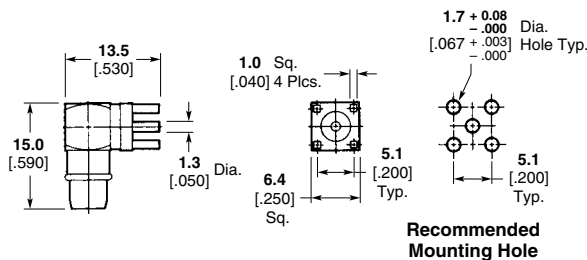

Plating	Part No.
Gold	1059691-1

**Surface Mount Vertical Plug with  
Small Leg**

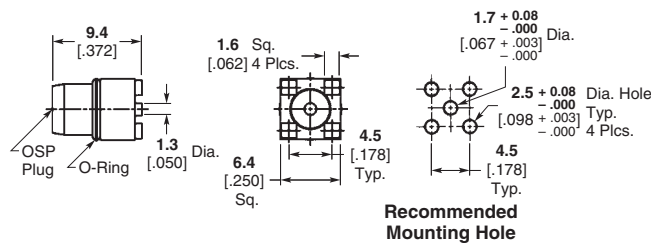

Plating	Part No.
Gold	1253111-1

**Note:** Part Numbers are RoHS compliant except: ♦ Indicates non-RoHS compliant.

**OSP Miniature Modular Blind Mate Connectors (Continued)**  
**Hermetically Sealed**

**Metal-To-Metal**  
**Rigid Gasket Seal —**  
**Panel Feedthrough**  
**Plug Receptacle**

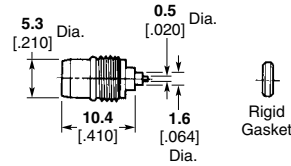

VSWR (GHz)	RF Leakage (dB)	Plating	Part No.
1.04 + .009f	-(90-fGHz)	Passivated stainless steel	<b>6059632-1</b>

Installation Thermal Limit: 250°C.  
Recommended Mounting Hole Detail A follows, pg 168.

**Rigid Gasket Seal —**  
**Panel Feedthrough**  
**Jack Receptacle**

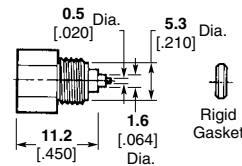

VSWR (GHz)	RF Leakage (dB)	Plating	Part No.
1.04 + .009f	-(90-fGHz)	Passivated stainless steel	<b>6059665-1</b>

Installation Thermal Limit: 250°C.  
Recommended Mounting Hole Detail A follows, pg 168.

**Field Replaceable**  
**Solder and Braze-In**  
**Panel Feedthrough Plug**  
**Receptacle**

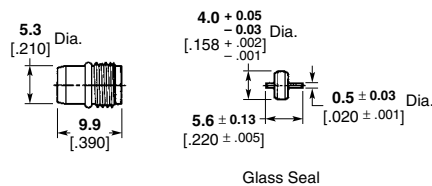

VSWR (GHz)	RF Leakage (dB)	Plating	Part No.
1.06 + .01f	-(90-fGHz)	Passivated stainless steel	<b>1059637-1</b>

Recommended Mounting Detail B or E follows, pg 168.

**Note:** Part Numbers are RoHS compliant except: ♦ Indicates non-RoHS compliant.

**OSP Miniature Modular Blind Mate Connectors (Continued)**  
**Hermetically Sealed (Continued)**

**Field Replaceable Solder and Braze-In**

(Continued)

**Panel Feedthrough Jack Receptacle**

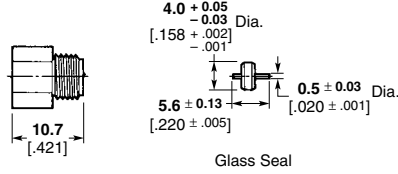

VSWR (GHz)	RF Leakage (dB)	Plating	Part No.
1.06 + .01f	-(90-fGHz)	Passivated stainless steel	<b>1059671-1</b>

Recommended Mounting Detail B or E follows at bottom of this page.

**2-Hole Flange Mount Plug Receptacle With EMI/RFI Gasket — 0.5 [0.018] Dia. Contact**

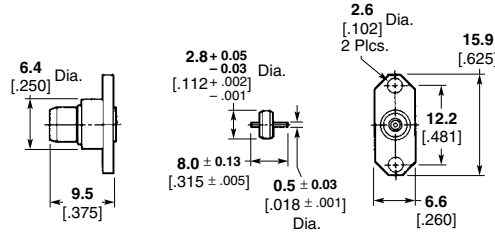

VSWR (GHz)	RF Leakage (dB)	Plating	Part No.
1.06 + .01f	-(90-fGHz)	Passivated stainless steel	<b>1059572-1</b>

Recommended Mounting Detail D follows at bottom of this page.

**Recommended Mounting Hole Detail**

**Detail A\***

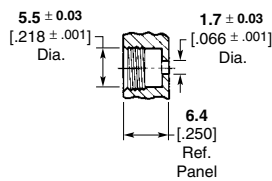

**Detail B\* (6.35 [0.250] Panel Thickness)**

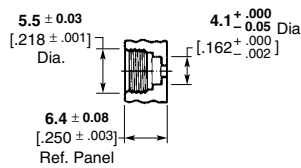

**Detail C\***

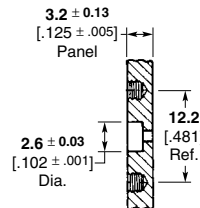

**Detail D\***

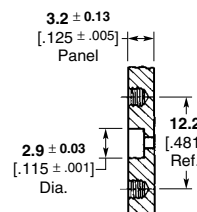

**Detail E\***

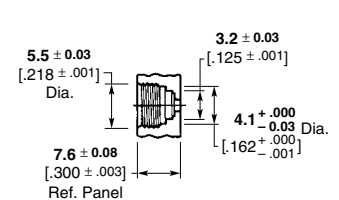

\*Consult appropriate Instruction Sheet for complete mounting details.

**Note:** Part Numbers are RoHS compliant except: ♦ Indicates non-RoHS compliant.

**OSSP Subminiature Modular Blind Mate Connectors**

**Product Facts**

- Subminiature version of OSP Blind Mate Connectors
- For space savings
- Family of connectors and adapters



OSSP connectors are a sub-miniature version of the OSP blind mate series. Connectors in this series incorporate the design elements of the OSP interface including the float and mis-mate features. OSSP blind mates are about 40% smaller than OSP connectors and are designed to be

used in applications where space is at a premium.

A complete family of OSSP connectors and adapters is available including cable connectors, fixed and float mount panel connectors and hermetic connectors. Rigid mount units will function to specifications up to

$\pm .064$  [ $\pm .0025$ ] radial misalignment with the mating plug connector. Applications requiring greater than  $\pm .064$  [ $\pm .0025$ ] radial misalignment can use either the float design or floating connector plates with guide pins.

**Engineering Data**

Impedance —	50 ohms
Frequency —	dc to 28.0 GHz
Temperature Rating —	-65° to 125° C

**Electrical**

VSWR —	1.05 + .01f (GHz)
RF Transmission Loss —	.040 x $\sqrt{f}$ (GHz)
Insulation Resistance —	5,000 megohms min.
Contact Resistance —	
Center Contact	6.0 milliohms max.
Outer Contact	3.0 milliohms max.
Outer Contact to Cable	0.5 milliohms max.
Dielectric Withstanding Voltage —	675 volts RMS
Corona Extinction Voltage at 70,000 Ft.—	250 volts min.
RF High Potential at 5 MHz —	675 volts RMS
RF Leakage Interface Only —	-(90-fGHz) dB min. (fully mated)
Power Handling —	300W at 3 GHz (sea level) and room temperature

**RG 405 (.085) Semi-Rigid**

**Environmental**

Corrosion —	Method 101, Condition B, MIL-STD-202
Vibration —	Method 204, Condition D, 20G's, MIL-STD-202
Shock —	Method 213, Condition I, 100G's, MIL-STD-202
Temperature Cycling —	Method 107, Condition B, MIL-STD-202
Moisture Resistance —	Method 106, MIL-STD-202

**Material**

Housing —	Corrosion resistant steel Type 303 (stainless) per ASTM A484 and A582
Center Contact —	Beryllium copper per ASTM-B-196
Dielectric —	TFE fluorocarbon per ASTM-D-1457
Gasket (O'Ring) —	MIL-P-25732

**Mechanical**

Force to Engage —	3 pounds max.
Force to Disengage —	1.5 pounds max.
Center Contact Retention —	4 pounds min.
Durability —	1,000 Cycles
Radial Misalignment —	
Rigid Mount	$\pm .06$ [ $\pm .0025$ ]
Float Mount	$\pm .51$ [ $\pm .020$ ]

**Mating Characteristics**

Jack Connector —		
Center Contact Socket	Oversize test Pin —	.533 + .003 [.0210 + .0001] dia.
	Test Pin Finish —	16 micro inch max.
	Insertion Depth —	.76/1.14 [.030/.045]
	Number of Insertions —	3
Insertion Force	Test Pin —	.528 + .003 [.0208 + .0001] dia.
	Test Pin Finish —	16 micro inch
	Insertion Force —	3 pounds max.
Withdrawal Force	Test Pin —	.495 + .003 [.0195 - .0001] dia.
	Test Pin Finish —	16 micro inch max.
	Insertion Depth —	1.27/1.91 [.050/.075]
	Withdrawal —	1/2 ounce min.

**Finish**

Center Contact —	Gold plate per MIL-G-45204, Type II, Class 0 over nickel plate per QQ-N-290, Class 2 or passivate per ASTM-A380
Housing —	Gold plate per MIL-G-45204, Type II, Class 0 over nickel plate per QQ-N-290, Class 2 or passivate per ASTM-A380

**OSSP Subminiature Modular Blind Mate Connectors (Continued)**

**Interface Mating  
Dimensions**

The connector interface, specifically designed for multiple interconnects, maintains reliable performance over the typical mechanical tolerance required in cost effective packaging.

The interface test data shows excellent performance is maintained with mating gaps up to .015 inch.

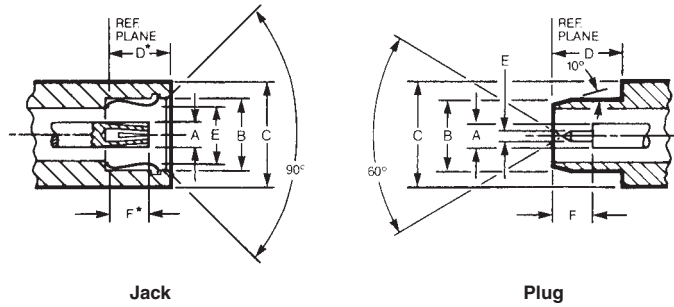

Description	Dimensions										
	A	B	C	D	E	F					
Jack	1.22 0.48	Nom. .154	3.91 Min.	5.33 .210	Ref. 5.00 .197	Nom.*	3.35 .132	Max.	3.23 .127	Max.*	
Plug	1.22 0.48	Nom.	3.56 Nom.	5.33 .210	Ref. 5.00 .199	Min.	0.51 .020	Nom.	3.25 .128	Min.	

\*With spring bottomed.

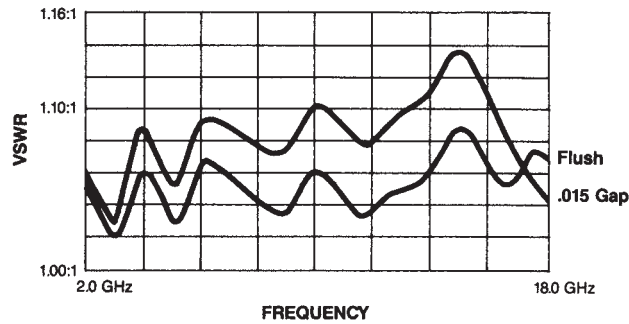

**OSSP Subminiature Modular Blind Mate Connectors (Continued)**  
**For Semi-Rigid Cable, Direct Solder Attachment**

**Bulkhead Feedthrough Cable Plug — Rear Mount**

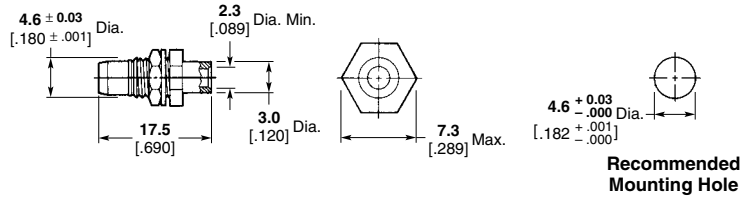

Cable	Plating	Part No.
RG 405/U, 2.16 [.085]	Gold	1059857-1

**Flange Mount Cable Jack — Floating Rear Mount**

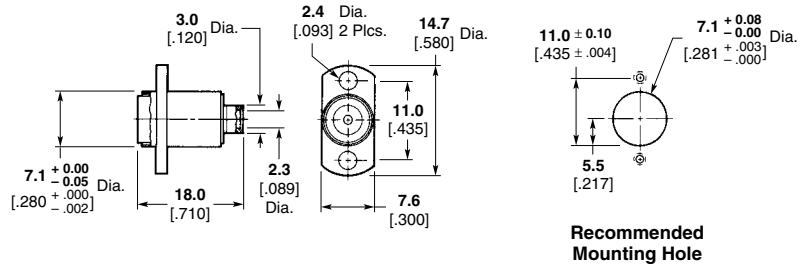

Cable	Part No.
RG 405/U, 2.16 [.085]	1059868-1

Finish: Inner housing that is soldered to cable is gold plated. Outer housing is passivated stainless steel.  
When using semi-rigid cable, it is recommended that a service loop be used to facilitate the float features of the connector.

**Feedthrough Snap-In**

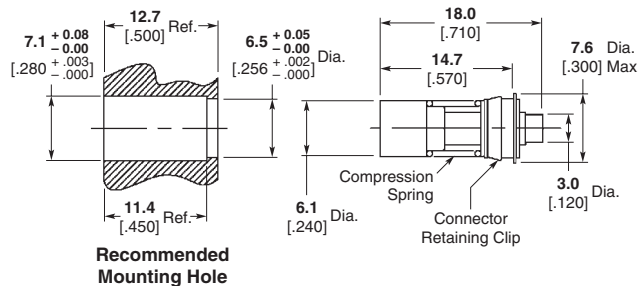

Cable	Part No.
RG 405/U, 2.16 [.085]	1059874-1

**Note:** Part Numbers are RoHS compliant except: ♦ Indicates non-RoHS compliant.

**OSSP Subminiature Modular Blind Mate Connectors (Continued)**  
**For Flexible Cable, Crimp Attachment**

**Bulkhead Feedthrough Cable Plug — Rear Mount**

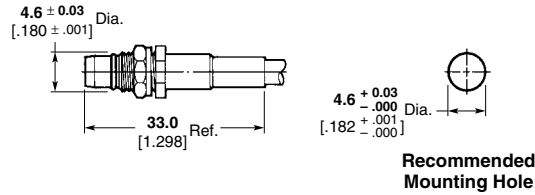

Cable	Plating	Part No.
RG 188/U, 316 Double Braided Only	Passivated Stainless Steel	<b>1059884-1</b>
RG 174/U, 188/U, 316U	Passivated Stainless Steel	<b>1059886-1</b>

**Flange Mount Cable Jack — Floating Rear Mount**

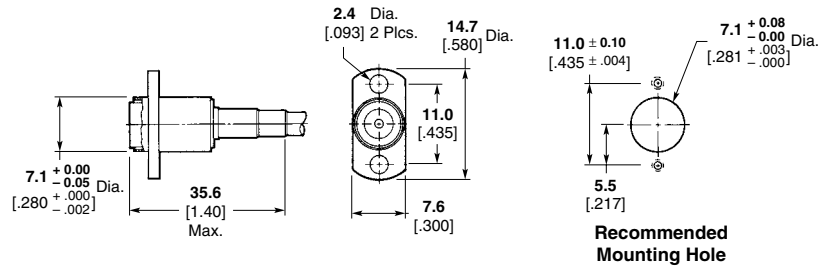

Cable	Plating	Part No.
RG 188/U, 316 Double Braided Only	Passivated Stainless Steel	<b>1059888-1</b>
RG 174/U, 188/U, 316U	Passivated Stainless Steel	<b>1059887-1</b>

**Feedthrough Snap-In Cable Jack**

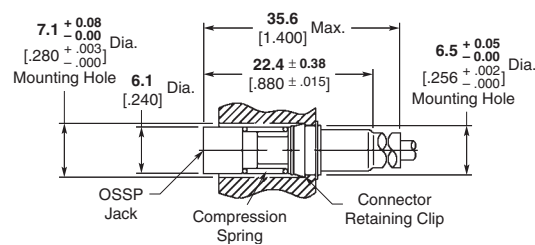

Part No.
<b>1059889-1</b>

**Note:** Part Numbers are RoHS compliant except: ♦ Indicates non-RoHS compliant.



**OSSP Subminiature Modular Blind Mate Connectors (Continued)**  
**For Panel Mount**

**Threaded Panel Feedthrough Plug Receptacle, Straight Terminal**

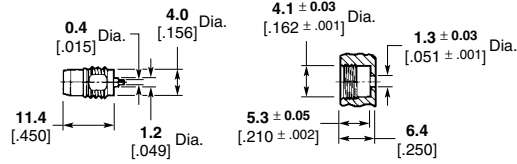

**Recommended Mounting Hole**

Plating	Part No.
Passivated Stainless Steel	<b>1059903-1</b>

**Press-Fit Panel Feedthrough Plug Receptacle**

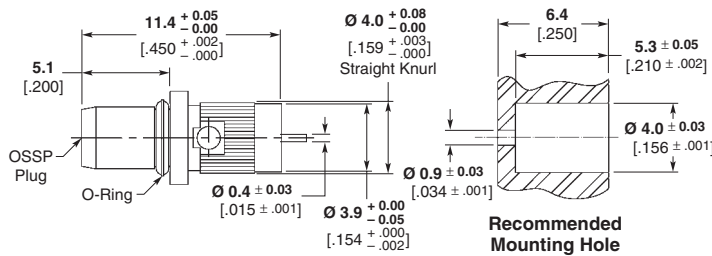

**Recommended Mounting Hole**

Part No.
<b>1059901-1</b>

**Note:** Part Numbers are RoHS compliant except: ♦ Indicates non-RoHS compliant.

**OSSP Subminiature Modular Blind Mate Connectors (Continued)**  
**For Printed Circuit Board Mount**

**Straight Plug Receptacle —  
Captured Contact**

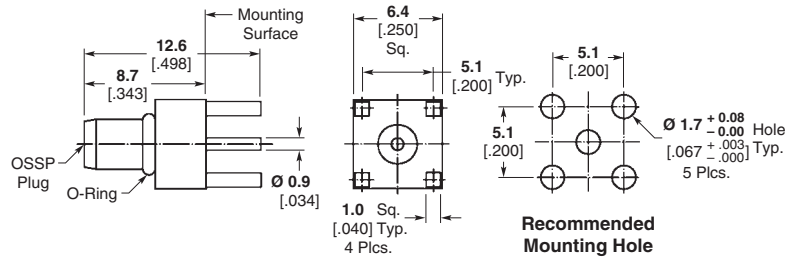

<b>Part No.</b>
<b>1059919-1</b>

**Right-Angle  
Plug Receptacle**

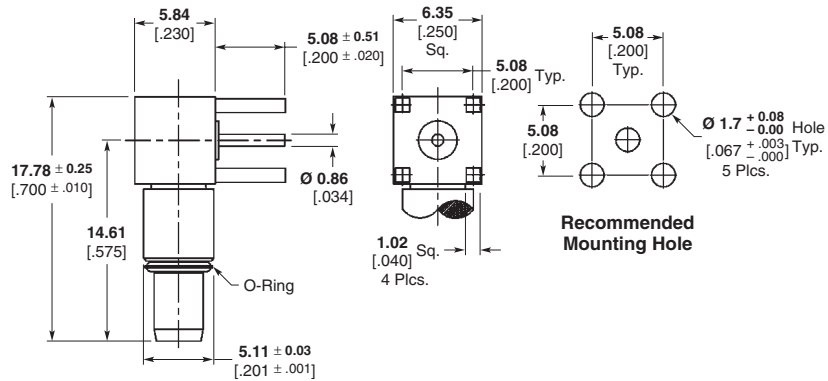

<b>Part Number</b>
<b>1484546-1</b>

**Note:** Part Numbers are RoHS compliant except: ♦ Indicates non-RoHS compliant.

**OSSP Subminiature Modular Blind Mate Connectors (Continued)**  
**Hermetically Sealed**

**Metal to Metal**

**Formable Gasket —  
Panel Feedthrough Plug  
Receptacle**

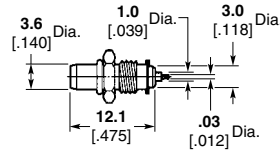

VSWR (GHz)	RF Leakage (dB)	Plating	Part No.
1.06 + .01f	-(85-fGHz)	Gold	<b>1059905-1</b>

Recommended Mounting Hole Detail A at bottom of this page.

**Solder and Braze-In**

**Panel Feedthrough Plug  
Receptacle**

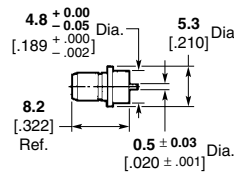

VSWR (GHz)	RF Leakage (dB)	Plating	Part No.
1.06 + .01f	-(85-fGHz)	Gold	<b>1059902-1</b>

Recommended Mounting Hole Detail B at bottom of this page.

**Field Replaceable  
Solder and Braze-In**

**2-Hole Flange Mount  
Plug Receptacle With  
EMI/RFI Gasket**

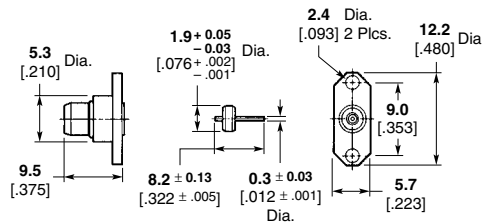

VSWR (GHz)	RF Leakage (dB)	Plating	Part No.
1.06 + .01f	-(85-fGHz)	Passivated Stainless Steel	<b>1059894-1</b>

Recommended Mounting Hole Detail C at bottom of this page.

**Recommended  
Mounting Hole Detail for  
Hermetically Sealed**

**Detail A\***

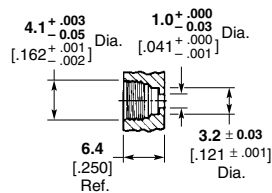

**Detail B\***

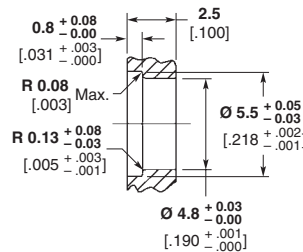

**Detail C\***

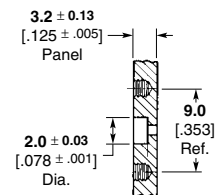

**Note:** Part Numbers are RoHS compliant except: ♦ Indicates non-RoHS compliant.

\*Consult appropriate Instruction Sheet for complete mounting procedure.

# Mouser Electronics

Authorized Distributor

Click to View Pricing, Inventory, Delivery & Lifecycle Information:

[TE Connectivity:](#)

[1059566-1](#)