

1

2

3

4

5

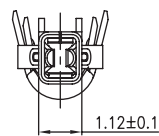

TECHNICAL CHARACTERISTICS

MATERIAL

CONTACT MATERIAL: COPPER ALLOY
 CONTACT TYPE: STAMPED
 CONTACT PLATING: TIN
 QUALITY CLASS: 25 MATING CYCLES
 PITCH: FOR 3.00MM

ENVIRONMENTAL

OPERATING TEMPERATURE: -25 UP TO 105°C
 COMPLIANCE: LEAD FREE AND ROHS

ELECTRICAL

CURRENT RATING: 5A
 WORKING VOLTAGE: 250 VAC
 INSULATOR RESISTANCE: >1000 MOHM
 DIELECTRIC WITHSTANDING VOLTAGE: 1000 VAC/MN
 CONTACT RESISTANCE: 10 MOHM MAX

WIRE DIMENSION

AWG: AWG 20 - 24

PACKAGING

REEL OF 10KPCS

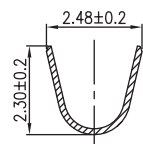
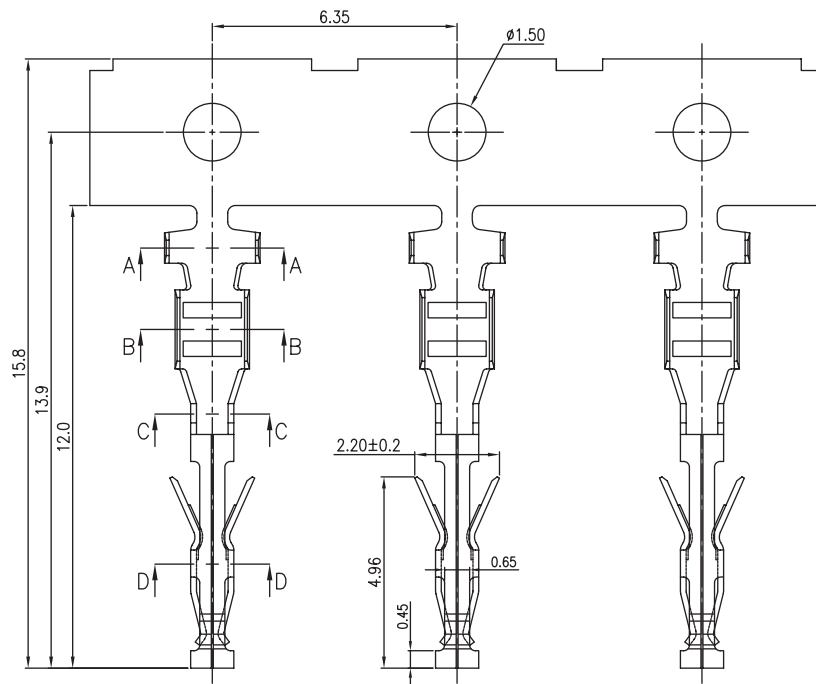
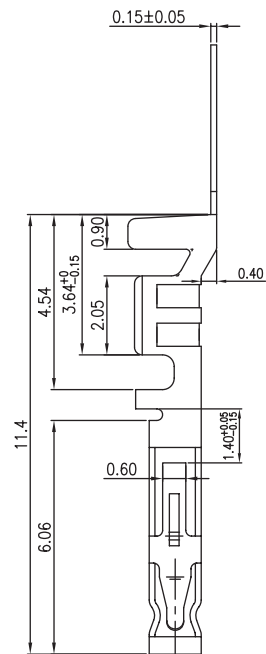

A-A

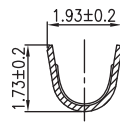

B-B

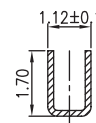

C-C

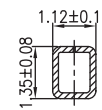

D-D

RoHS Compliant

PROJECTION:



GENERAL TOLERANCE

.X = +/- 0.2

.XX = +/- 0.15



APPROVAL: BBu

UNIT: MM

DESCRIPTION: 3.00MM FEMALE CRIMP TERMINAL LOW FORCE

SIZE

01-SEP-16

RESISTANCE

AK

SCALE:

WERI PART NO: 662 003 137 22

A4

02-NOV-11

PDF

GG

SHEET: 1/3

DRAW: MIKE

DATE

FILE

BY

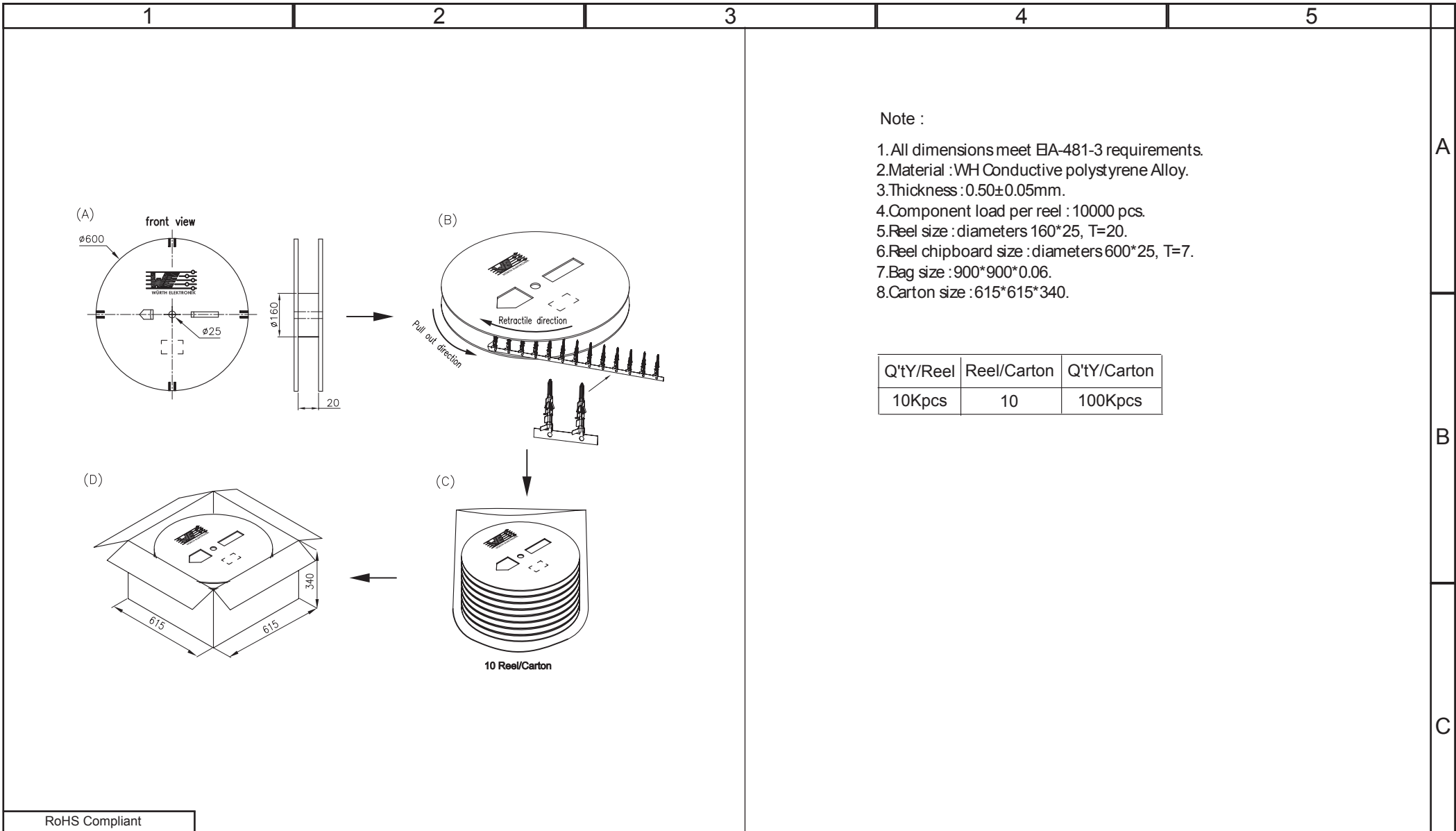

Note :

- 1. All dimensions meet IEC-481-3 requirements.
- 2. Material :WH Conductive polystyrene Alloy.
- 3. Thickness :0.50±0.05mm.
- 4. Component load per reel : 10000 pcs.
- 5. Reel size : diameters 160*25, T=20.
- 6. Reel chipboard size : diameters 600*25, T=7.
- 7. Bag size : 900*900*0.06.
- 8. Carton size : 615*615*340.

Q'tY/Reel	Reel/Carton	Q'tY/Carton
10Kpcs	10	100Kpcs

RoHS Compliant			
G			
F			
E			
D			
C			
B			
A			
REV	DATE	FILE	BY

PROJECTION:
APPROVAL: BBu

GENERAL TOLERANCE
.X = +/- 0.2
.XX = +/- 0.15
UNIT: MM
SCALE:
SHEET: 2/3
DRAW: MIKE

DESCRIPTION: 3.00MM FEMALE CRIMP TERMINAL LOW FORCE	
WERI PART NO: 662 003 137 22	

SIZE
A4

1

2

3

4

5

Cautions and Warnings:

This electronic component is designed and developed with the intention for use in general electronics equipments.

Before incorporating the components into any equipments in the field such as aerospace, aviation, nuclear control, submarine, transportation, (automotive control, train control, ship control), transportation signal, disaster prevention, medical, public information network etc. where higher safety and reliability are especially required or if there is possibility of direct damage or injury to human body, Würth Elektronik must be asked for a written approval.



In addition, even electronic component in general electronic equipments, when used in electrical circuits that require high safety, reliability functions or performance, the sufficient reliability evaluation-check for the safety must be performed before by the user before usage.

A

B

C

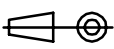
RoHS Compliant

G				PROJECTION: 	GENERAL TOLERANCE .X = +/- 0.2 .XX = +/- 0.15		
F							
E							
D							
C				APPROVAL: JC	UNIT: MM	DESCRIPTION: DISCLAIMER	SIZE A4
B					SCALE:		
A	10-SEP-14	PDF	QL		SHEET: 3/3	WERI PART NO: DISCLAIMER	
REV	DATE	FILE	BY		DRAW: QL		

D

Mouser Electronics

Authorized Distributor

Click to View Pricing, Inventory, Delivery & Lifecycle Information:

[Wurth Electronics:](#)

[66200313722DEC](#)