



# 60×60×25 mm

San Ace 60 9G type

## General Specifications

- Material ..... Frame: Plastic (Flammability: UL 94V-0), Impeller: Plastic (Flammability: UL 94V-0)
- Expected life ..... See the table below. (L10 life: 90% survival rate for continuous operation in free air at 60°C, rated voltage)
- Motor protection function ..... Locked rotor burnout protection, Reverse polarity protection  
For details, please refer to p. 529.
- Dielectric strength ..... 50/60 Hz, 500 VAC, for 1 minute (between lead wire conductors and frame)
- Insulation resistance ..... 10 MΩ or more with a 500 VDC megger (between lead wire conductors and frame)
- Sound pressure level (SPL) ..... At 1 m away from the air inlet
- Storage temperature ..... -30 to +70°C (Non-condensing)
- Lead wire ..... ⊕Red ⊖Black (Sensor) Yellow (Control) Brown
- Mass ..... 90 g

## Specifications

The models listed below **have ribs and pulse sensors with PWM control function.** For models without ribs, append "1" to the end of model numbers.

Model no.	Rated voltage [V]	Operating voltage range [V]	PWM duty cycle* [%]	Rated current [A]	Rated input [W]	Rated speed [min <sup>-1</sup> ]	Max. airflow [m <sup>3</sup> /min] [CFM]	Max. static pressure [Pa] [inchH <sub>2</sub> O]	SPL [dB (A)]	Operating temperature [°C]	Expected life [h]
9G0612P4S001	12	10.2 to 13.8	100	0.67	8.04	11000	1.4 49.4	300 1.2	53	-20 to +70	40000/60°C (70000/40°C)
			0	0.07	0.84	3300	0.42 14.8	27 0.11	19		
9G0612P4H001	12	10.2 to 13.8	100	0.5	6.0	9500	1.21 42.7	224 0.9	49		
			0	0.06	0.72	2850	0.36 12.7	20.2 0.08	18		
9G0624P4S001	24	20.4 to 27.6	100	0.34	8.16	11000	1.4 49.4	300 1.2	53		
			0	0.04	0.96	3300	0.42 14.8	27 0.11	19		
9G0624P4H001	24	20.4 to 27.6	100	0.25	6.0	9500	1.21 42.7	224 0.9	49		
			0	0.04	0.96	2850	0.36 12.7	20.2 0.08	18		
9G0648P4S001	48	36 to 72	100	0.18	8.64	11000	1.4 49.4	305 1.22	53		
			0	0.02	0.96	3300	0.42 14.8	27.4 0.11	19		

\* PWM frequency: 25 kHz

Other sensor specifications are available as options. Refer to the index (pp. 548 to 549).

## Airflow - Static Pressure Characteristics / PWM Duty - Speed Characteristics Example

**9G0612P4S001** With pulse sensor with PWM control function

PWM duty cycle

Operating voltage range

PWM duty - Speed characteristics example

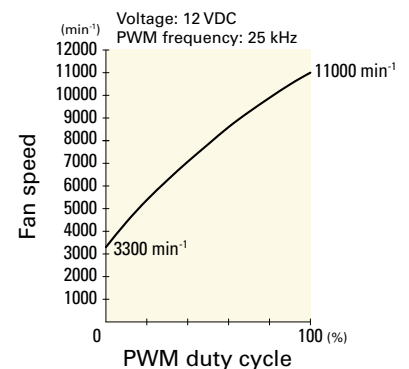
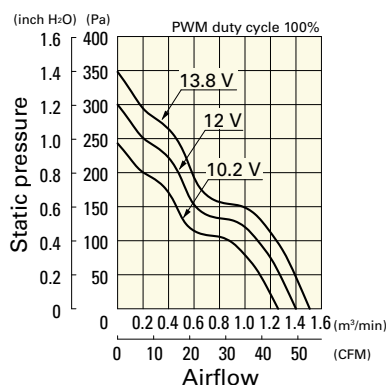
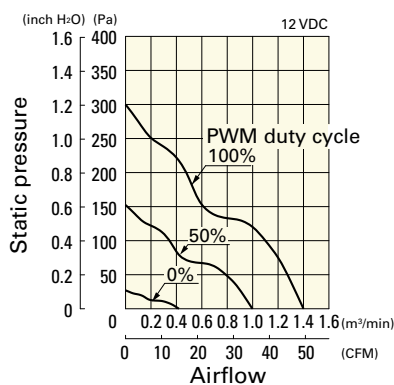

# Airflow - Static Pressure Characteristics / PWM Duty - Speed Characteristics Example

**9G0612P4H001** With pulse sensor with PWM control function

PWM duty cycle

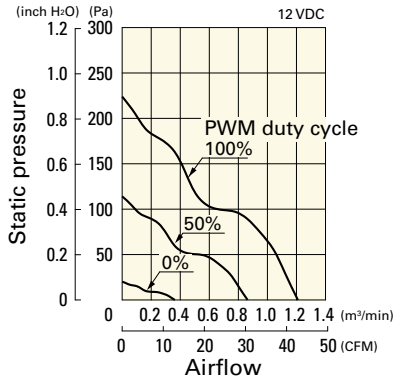

Operating voltage range

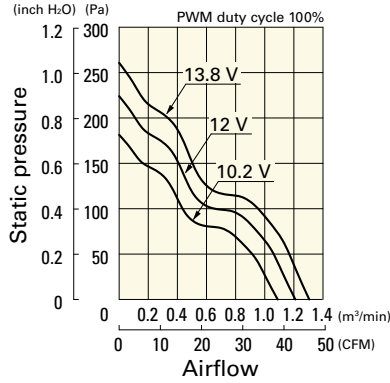

PWM duty - Speed characteristics example

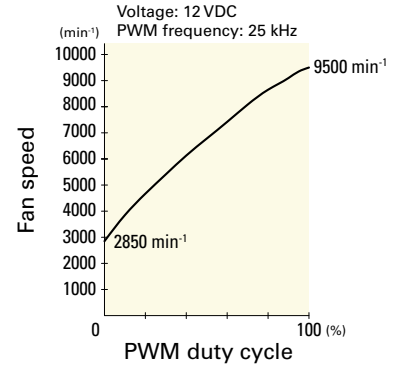

**9G0624P4S001** With pulse sensor with PWM control function

PWM duty cycle

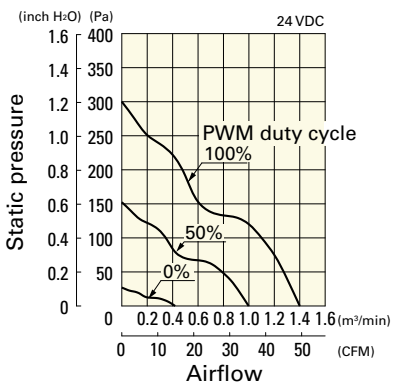

Operating voltage range

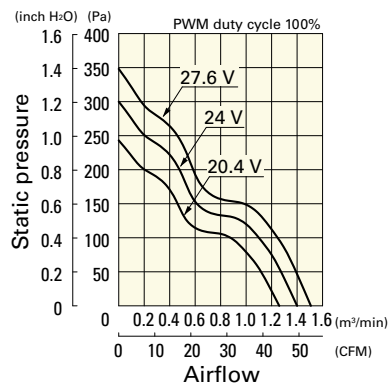

PWM duty - Speed characteristics example

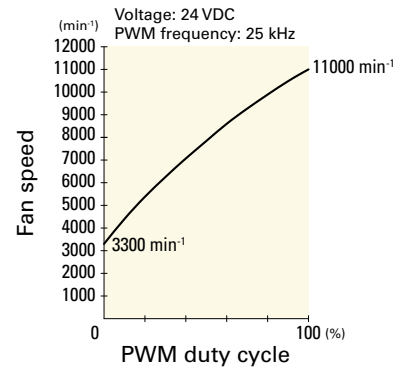

**9G0624P4H001** With pulse sensor with PWM control function

PWM duty cycle

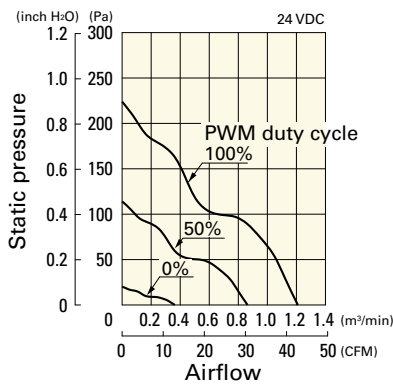

Operating voltage range

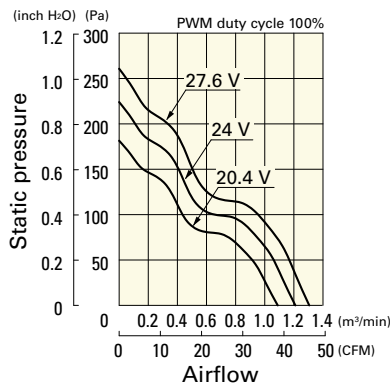

PWM duty - Speed characteristics example

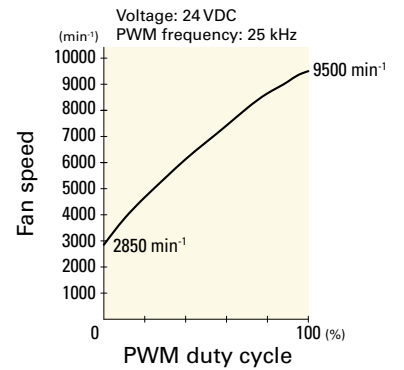

**9G0648P4S001** With pulse sensor with PWM control function

PWM duty cycle

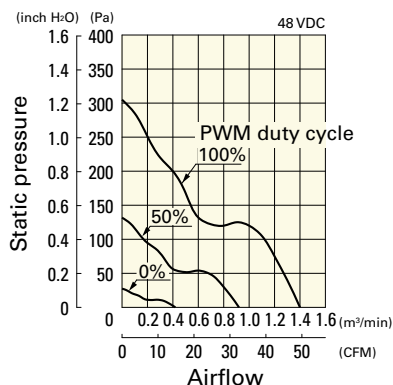

Operating voltage range

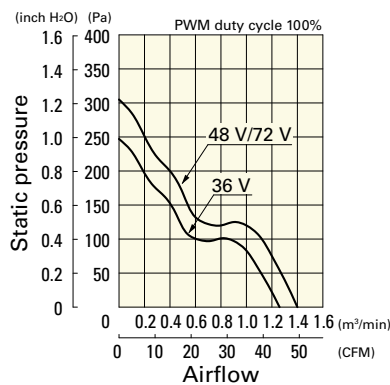

PWM duty - Speed characteristics example

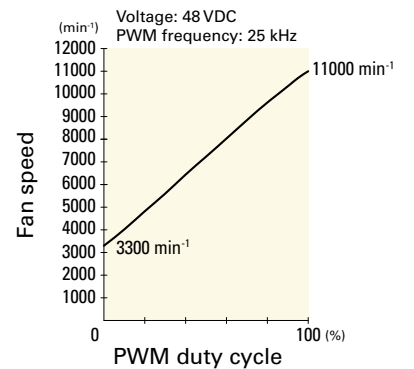

**Dimensions (unit: mm)** (With ribs)

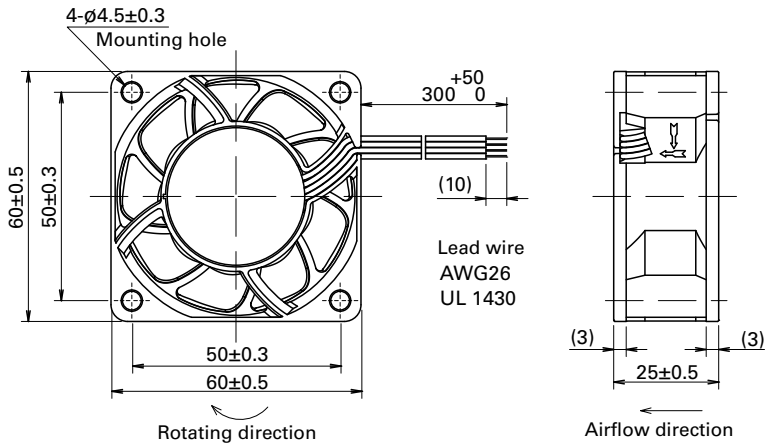

**Reference Dimensions of Mounting Holes and Vent Opening (unit: mm)**

Inlet side, Outlet side

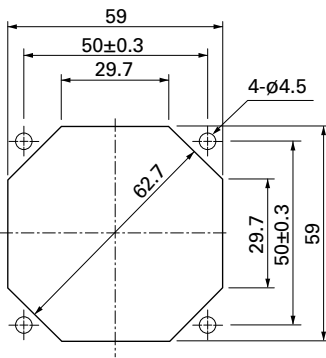

**Options**

**Finger guards**

page: p. 513

Model no.: 109-139E, 109-139H

**Resin finger guards**

page: p. 520

Model no.: 109-1003G

**Resin filter kits**

page: p. 521

Model no.: 109-1003F13 (13PPI), 109-1003F20 (20PPI),  
109-1003F30 (30PPI), 109-1003F40 (40PPI)

# Mouser Electronics

Authorized Distributor

Click to View Pricing, Inventory, Delivery & Lifecycle Information:

## Sanyo Denki:

[9G0612P4H0011](#) [9G0612P4S0011](#) [9G0612P4S001](#) [9G0648P4S001](#) [9G0612P4H001](#) [9G0624P4S001](#)  
[9G0648P4S0011](#) [9G0624P4H0011](#) [9G0624P4H001](#) [9G0612H40011](#) [9G0624P4S0011](#) [9G0612S4001](#)  
[9G0612S4002](#) [9G0624S4002](#) [9G0624H4001](#) [9G0624H4002](#) [9G0624H40021](#) [9G0624H4D001](#) [9G0624S40021](#)  
[9G0624S4D001](#) [9G0612H4002](#) [9G0612H40021](#) [9G0612H4D001](#) [9G0612H4D0011](#) [9G0612S40021](#)