

Description

The AP3427M is a high efficiency step-down dual channel DC-DC voltage converter. The chip operation is optimized by peak-current mode architecture with built-in synchronous power MOSFET switchers. The oscillator and timing capacitors are all built-in providing an internal switching frequency of 1.5MHz that allows the use of small surface mount inductors and capacitors for portable product implementations.

Integrated Soft Start (SS), Under Voltage Lock Out (UVLO), Thermal Shutdown Detection (TSD) and Short Circuit Protection are designed to provide reliable product applications.

The device is available in adjustable output voltage ranging from 0.6V to $0.9 \times V_{IN}$ when input voltage range is from 2.5V to 5.5V, and is able to deliver up to 1A for each output.

The AP3427M is available in standard U-DFN3030-10 package.

Features

- High Efficiency Buck Power Converter
- Output Current: 1.0A/1.0A
- Low $R_{DS(ON)}$ Internal Switches: 200m Ω ($V_{IN}=5V$)
- Adjustable Output Voltages from 0.6V to $0.9 \times V_{IN}$
- Wide Operating Voltage Range: 2.5V to 5.5V
- Built-In Power Switches for Synchronous Rectification with High Efficiency
- Feedback Voltage: 600mV
- 1.5MHz Constant Frequency Operation
- Thermal Shutdown Protection
- Low Drop-Out Operation at 100% Duty Cycle
- Input Over Voltage Protection
- No Schottky Diode Required
- **Totally Lead-Free & Fully RoHS Compliant (Notes 1 & 2)**
- **Halogen and Antimony Free. "Green" Device (Note 3)**

Notes:

1. No purposely added lead. Fully EU Directive 2002/95/EC (RoHS) & 2011/65/EU (RoHS 2) compliant.
2. See http://www.diodes.com/quality/lead_free.html for more information about Diodes Incorporated's definitions of Halogen- and Antimony-free, "Green" and Lead-free.
3. Halogen- and Antimony-free "Green" products are defined as those which contain <900ppm bromine, <900ppm chlorine (<1500ppm total Br + Cl) and <1000ppm antimony compounds.

Pin Assignments

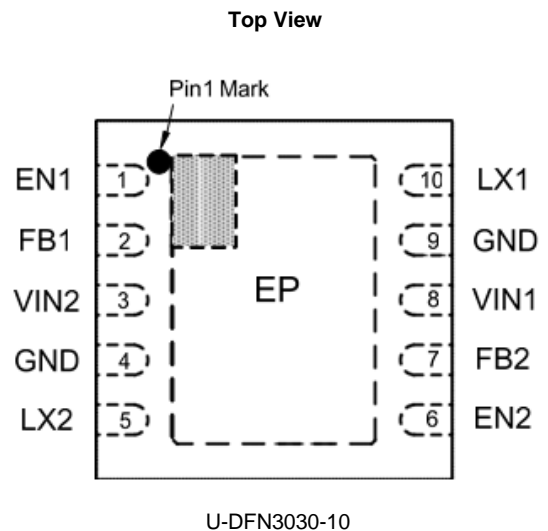

Applications

- Post DC-DC Voltage Regulation
- PDA and Notebook Computer

Typical Applications Circuit

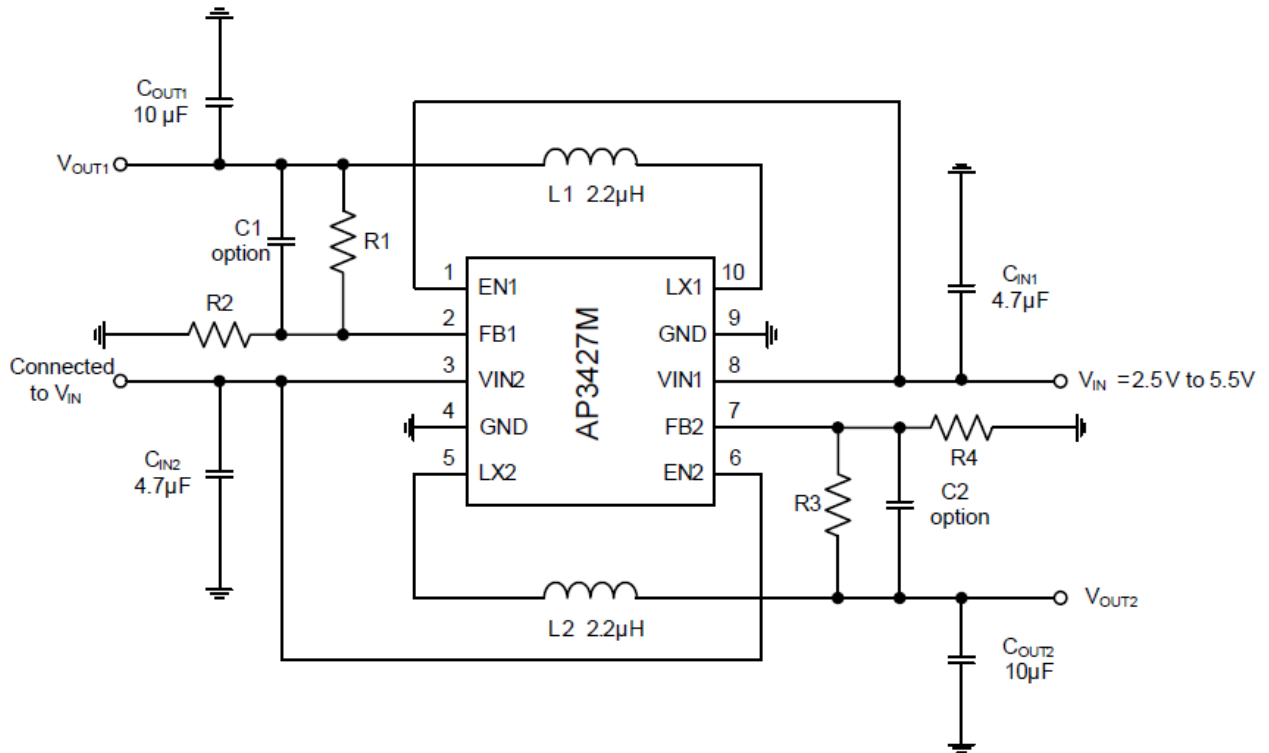

Pin Descriptions

Pin Number	Pin Name	Function
1	EN1	Enable signal input of channel 1, active high
2	FB1	Feedback voltage of channel 1
3	VIN2	Power supply input of channel 2
4, 9, Exposed Pad	GND	GND. It should be connected to system ground
5	LX2	Connected from channel 2's Power MOSFET to inductor
6	EN2	Enable signal input of channel 2, active high
7	FB2	Feedback voltage of channel 2
8	VIN1	Power supply input of channel 1
10	LX1	Connected from channel 1's Power MOSFET to inductor

Functional Block Diagram

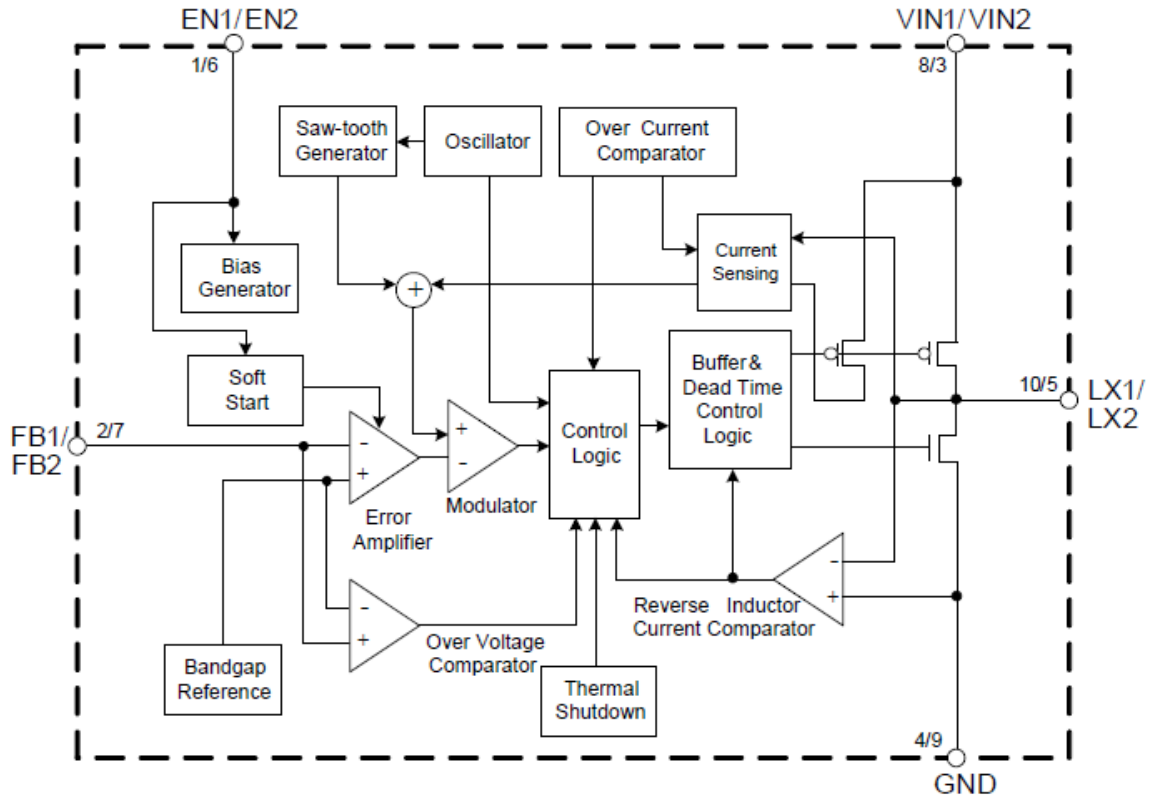

Absolute Maximum Ratings (@T_A = +25°C, unless otherwise specified.) (Note 4)

Parameter	Symbol	Value	Unit
Supply Input Voltage for the MOSFET Switch	V _{IN1} , V _{IN2}	0 to 6.5	V
LX Pin Switch Voltage	V _{LX1} , V _{LX2}	-0.3 to V _{IN} +0.3	V
Enable Input Voltage	V _{EN2} , V _{EN2}	-0.3 to V _{IN} +0.3	V
LX Pin Switch Current	I _{LX1} , I _{LX2}	1.8	A
Power Dissipation (On PCB, T _A =+25°C)	P _D	2.44	W
Thermal Resistance (Junction to Ambient, Simulation)	θ _{JA}	41	°C/W
Thermal Resistance (Junction to Case, Simulation)	θ _{JC}	4.2	°C/W
Operating Junction Temperature	T _J	+155	°C
Operating Temperature	T _{OP}	-40 to +85	°C
Storage Temperature Range	T _{STG}	-55 to 150	°C
ESD (Human Body Model)	V _{HBM}	2,000	V
ESD (Machine Model)	V _{MM}	200	V

Note: 4. Stresses greater than those listed under "Absolute Maximum Ratings" may cause permanent damage to the device. These are stress ratings only, and functional operation of the device at these or any other conditions beyond those indicated under "Recommended Operating Conditions" is not implied. Exposure to "Absolute Maximum Ratings" for extended periods may affect device reliability.

Recommended Operating Conditions (@T_A = +25°C, unless otherwise specified.)

Symbol	Parameter	Min	Max	Unit
V _{IN}	Supply Input Voltage	2.5	5.5	V
T _J	Operating Junction Temperature	-40	+125	°C
T _A	Ambient Temperature	-40	+80	°C

Electrical Characteristics (@T_A = +25°C, unless otherwise specified.) (V_{IN}=V_{IN1}=V_{IN2}=5V, V_{EN1}=V_{EN2}=5V, V_{FB1}=V_{FB2}=0.6V, L₁=L₂=2.2μH, C_{IN1}=C_{IN2}=4.7μF, C_{OUT1}=C_{OUT2}=10μF, I_{MAX}=1A per Channel, unless otherwise specified.)

Parameter	Symbol	Condition	Min	Typ	Max	Unit
Input Voltage Range	V _{IN}	V _{IN} = V _{IN1} = V _{IN2}	2.5	—	5.5	V
Shutdown Current	I _{OFF}	V _{EN1} = V _{EN2} = 0	—	0.1	1	μA
Active Current	I _{ON}	V _{FB1} = V _{FB2} = 0.7V, I _{OUT1} = I _{OUT2} = 0A	—	220	—	μA
Regulated Feedback Voltage	V _{FB}	For Adjustable Output Voltage	0.588	0.6	0.612	V
Regulated Output Voltage Accuracy	ΔV _{OUT} /V _{OUT}	V _{IN} = 2.5V to 5.5V, I _{OUT1} or I _{OUT2} = 0 to 1A	-3	—	3	%
Peak Inductor Current	I _{PK}	—	1.5	—	—	A
Oscillator Frequency	f _{OSC}	V _{IN} = 2.5V to 5.5V	1.2	1.5	1.8	MHz
PMOSFET R _{DS(ON)}	R _{DS(ON)_P}	V _{IN} = 5V	—	200	—	mΩ
NMOSFET R _{DS(ON)}	R _{DS(ON)_N}	V _{IN} = 5V	—	200	—	mΩ
EN High-Level Input Voltage	V _{EN_H}	—	1.5	—	—	V
EN Low-Level Input Voltage	V _{EN_L}	—	—	—	0.4	V
EN Input Current	I _{EN}	—	—	—	0.1	μA
Soft Start Time	t _{SS}	—	—	400	—	μs
Maximum Duty Cycle	D _{MAX}	—	100	—	—	%
Input Over Voltage Protection	V _{OIP}	—	—	6.2	—	V
Under Voltage Lock Out Threshold	V _{UVLO}	Rising	—	2.3	—	V
		Falling	—	2.1	—	
		Hysteresis	—	0.2	—	
Thermal Shutdown	T _{SD}	Hysteresis=+30°C	—	+155	—	°C

Typical Performance Characteristics

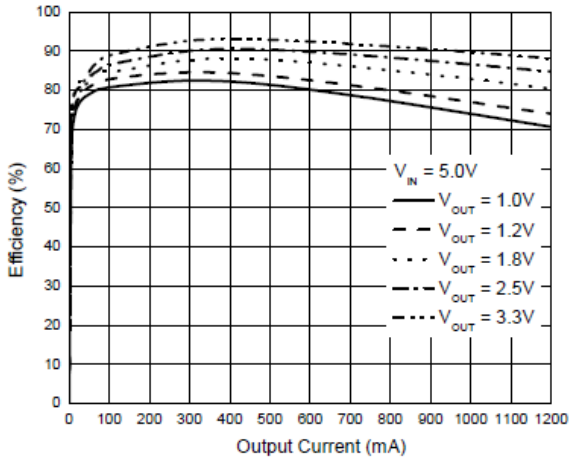

Figure 1 Efficiency vs. Output Current ($V_{IN} = 5V$)

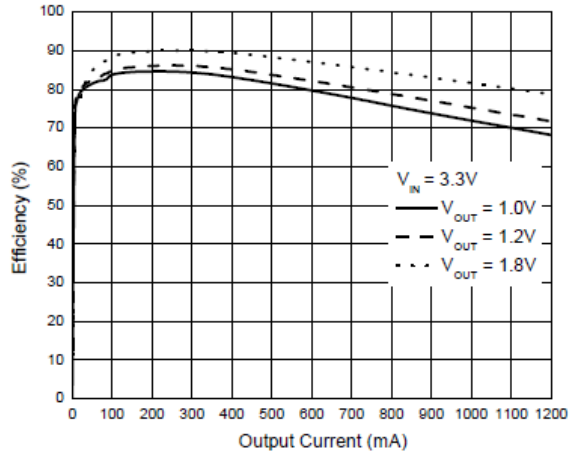

Figure 2 Efficiency vs. Output Current ($V_{IN} = 3.3V$)

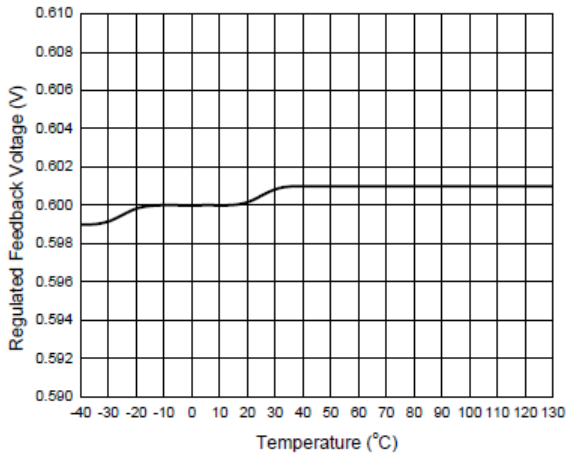

Figure 3 Regulated Feedback Voltage vs. Temperature

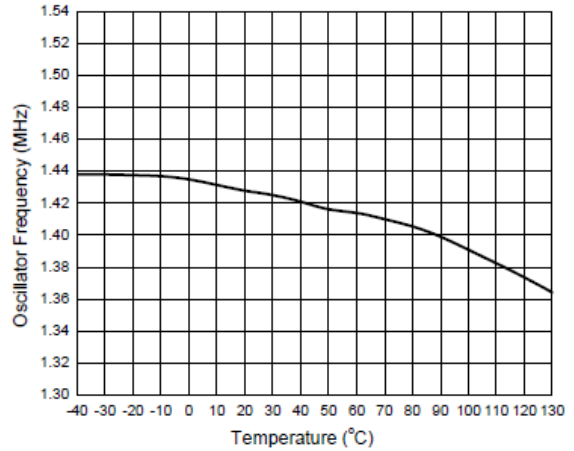

Figure 4 Oscillator Frequency vs. Temperature

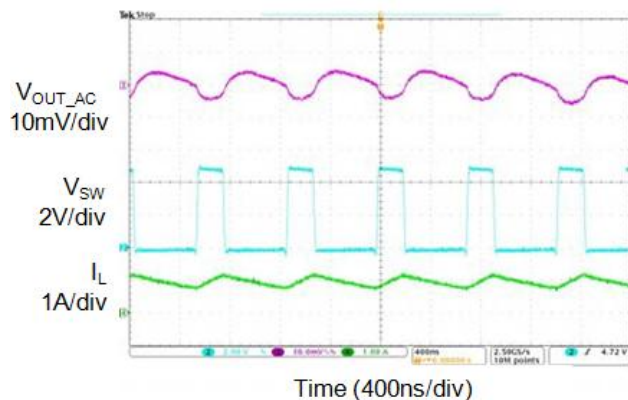

Figure 5 Output Ripple ($V_{OUT} = 1.2V$, $I_{OUT} = 1A$)

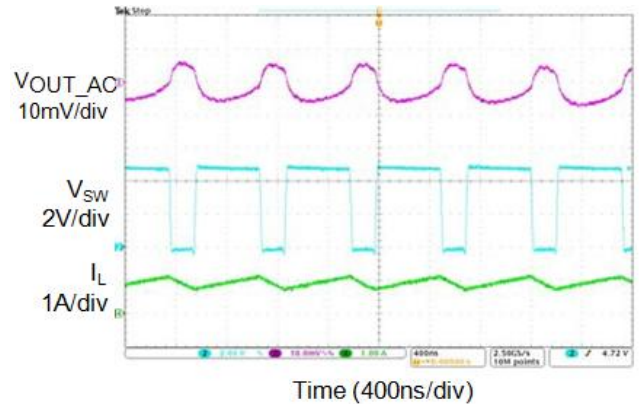
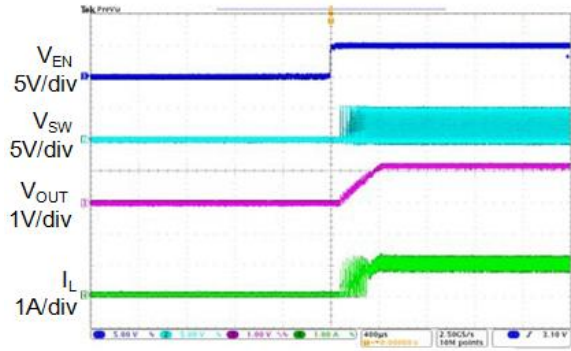
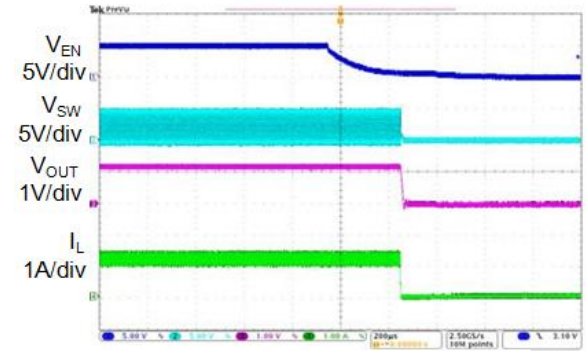

Figure 6 Output Ripple ($V_{OUT} = 3.3V$, $I_{OUT} = 1A$)

Typical Performance Characteristics (Cont.)



Time (400µs/div)
Figure 7 Enable Turn On ($I_{OUT} = 1A$)



Time (200µs/div)
Figure 8 Enable Turn Off ($I_{OUT} = 1A$)

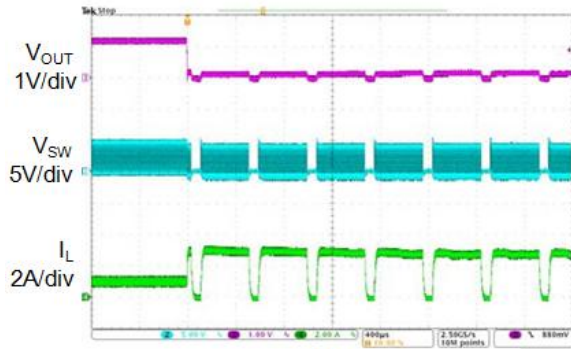

Time (400µs/div)
Figure 9 Short Circuit Protection ($I_{OUT} = 1A$)

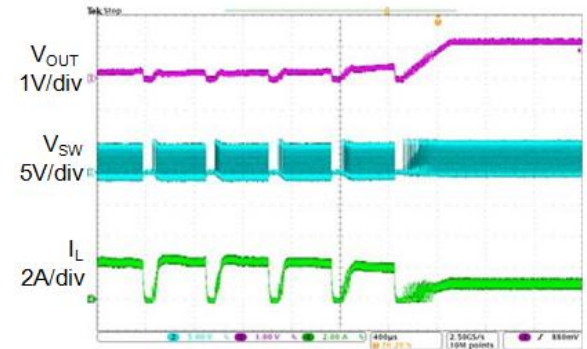

Time (400µs/div)
Figure 10 Short Circuit Protection Recovery ($I_{OUT} = 1A$)

Ordering Information

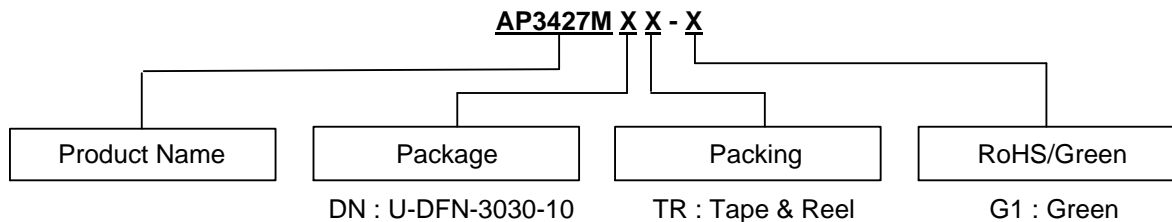

Part Number	Marking ID	Package	Temperature Range	13" Tape and Reel	
				Quantity	Part Number Suffix
AP3427MDNTR-G1	BFE	U-DFN3030-10	-40°C to +80°C	5000/Tape & Reel	-13

Marking Information

(Top View)

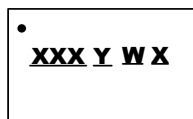

XXX : Identification Code
Y : Year 0~9
W : Week : A~Z : 1~26 week;
a~z : 27~52 week; z represents
52 and 53 week
X : Internal Code

Part Number	Package	Identification Code
AP3427MDNTR-G1	U-DFN3030-10	BFE

Package Outline Dimensions

Please see <http://www.diodes.com/package-outlines.html> for the latest version.

U-DFN3030-10

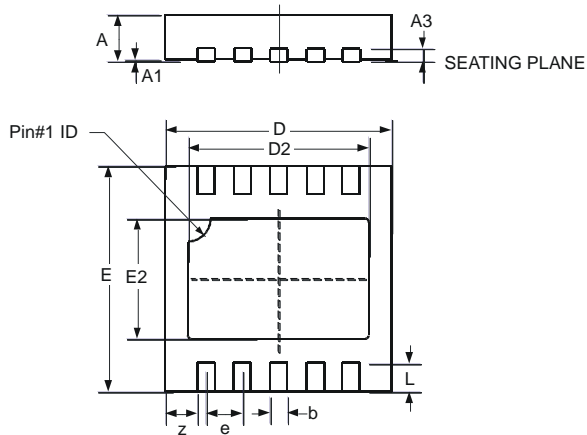

U-DFN3030-10			
Dim	Min	Max	Typ
A	0.57	0.63	0.60
A1	0	0.05	0.02
A3	-	-	0.15
b	0.20	0.30	0.25
D	2.90	3.10	3.00
D2	2.30	2.50	2.40
e	-	-	0.50
E	2.90	3.10	3.00
E2	1.50	1.70	1.60
L	0.25	0.55	0.40
z	-	-	0.375
All Dimensions in mm			

Suggested Pad Layout

Please see <http://www.diodes.com/package-outlines.html> for the latest version.

U-DFN3030-10

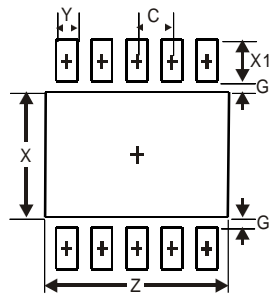

Dimensions	Value (in mm)
Z	2.60
G	0.15
X	1.80
X1	0.60
Y	0.30
C	0.50

IMPORTANT NOTICE

DIODES INCORPORATED MAKES NO WARRANTY OF ANY KIND, EXPRESS OR IMPLIED, WITH REGARDS TO THIS DOCUMENT, INCLUDING, BUT NOT LIMITED TO, THE IMPLIED WARRANTIES OF MERCHANTABILITY AND FITNESS FOR A PARTICULAR PURPOSE (AND THEIR EQUIVALENTS UNDER THE LAWS OF ANY JURISDICTION).

Diodes Incorporated and its subsidiaries reserve the right to make modifications, enhancements, improvements, corrections or other changes without further notice to this document and any product described herein. Diodes Incorporated does not assume any liability arising out of the application or use of this document or any product described herein; neither does Diodes Incorporated convey any license under its patent or trademark rights, nor the rights of others. Any Customer or user of this document or products described herein in such applications shall assume all risks of such use and will agree to hold Diodes Incorporated and all the companies whose products are represented on Diodes Incorporated website, harmless against all damages.

Diodes Incorporated does not warrant or accept any liability whatsoever in respect of any products purchased through unauthorized sales channel. Should Customers purchase or use Diodes Incorporated products for any unintended or unauthorized application, Customers shall indemnify and hold Diodes Incorporated and its representatives harmless against all claims, damages, expenses, and attorney fees arising out of, directly or indirectly, any claim of personal injury or death associated with such unintended or unauthorized application.

Products described herein may be covered by one or more United States, international or foreign patents pending. Product names and markings noted herein may also be covered by one or more United States, international or foreign trademarks.

This document is written in English but may be translated into multiple languages for reference. Only the English version of this document is the final and determinative format released by Diodes Incorporated.

LIFE SUPPORT

Diodes Incorporated products are specifically not authorized for use as critical components in life support devices or systems without the express written approval of the Chief Executive Officer of Diodes Incorporated. As used herein:

A. Life support devices or systems are devices or systems which:

1. are intended to implant into the body, or
2. support or sustain life and whose failure to perform when properly used in accordance with instructions for use provided in the labeling can be reasonably expected to result in significant injury to the user.

B. A critical component is any component in a life support device or system whose failure to perform can be reasonably expected to cause the failure of the life support device or to affect its safety or effectiveness.

Customers represent that they have all necessary expertise in the safety and regulatory ramifications of their life support devices or systems, and acknowledge and agree that they are solely responsible for all legal, regulatory and safety-related requirements concerning their products and any use of Diodes Incorporated products in such safety-critical, life support devices or systems, notwithstanding any devices- or systems-related information or support that may be provided by Diodes Incorporated. Further, Customers must fully indemnify Diodes Incorporated and its representatives against any damages arising out of the use of Diodes Incorporated products in such safety-critical, life support devices or systems.

Copyright © 2017, Diodes Incorporated

www.diodes.com

Mouser Electronics

Authorized Distributor

Click to View Pricing, Inventory, Delivery & Lifecycle Information:

[Diodes Incorporated:](#)

[AP3427MDNTR-G1](#) [AP3427DNTR-G1](#)