

THIS DRAWING IS UNPUBLISHED. RELEASED FOR PUBLICATION  
 © COPYRIGHT BY TYCO ELECTRONICS CORPORATION. ALL RIGHTS RESERVED.

LOC		DIST		REVISIONS			
P	LTR	DESCRIPTION	DATE	DWN	APVD		
	A1	REVISED PER ECO-06-17112	7/18/06	SS	SRY		

- 1. MATERIAL: 0.80[.032] THICK, BRASS TEMPERED.
- 2. FINISH: BRIGHT TIN PLATE.

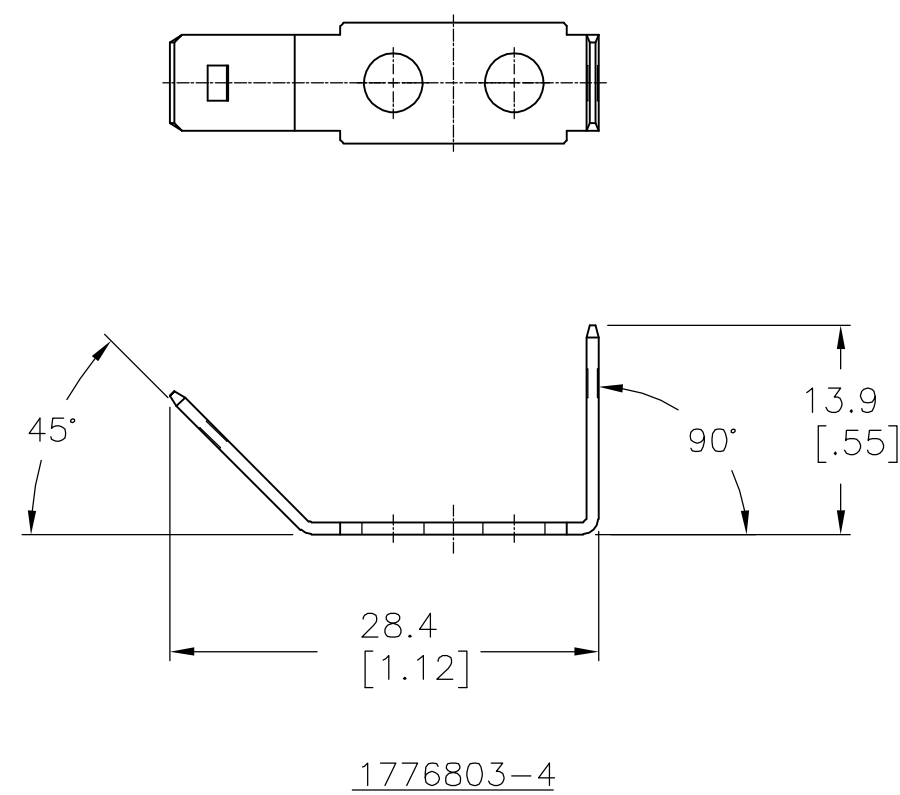
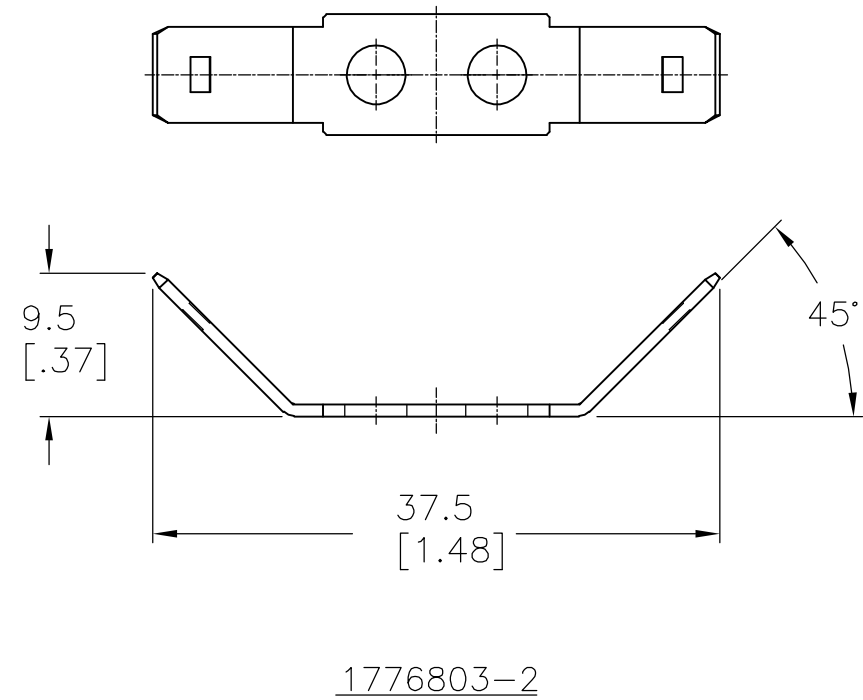
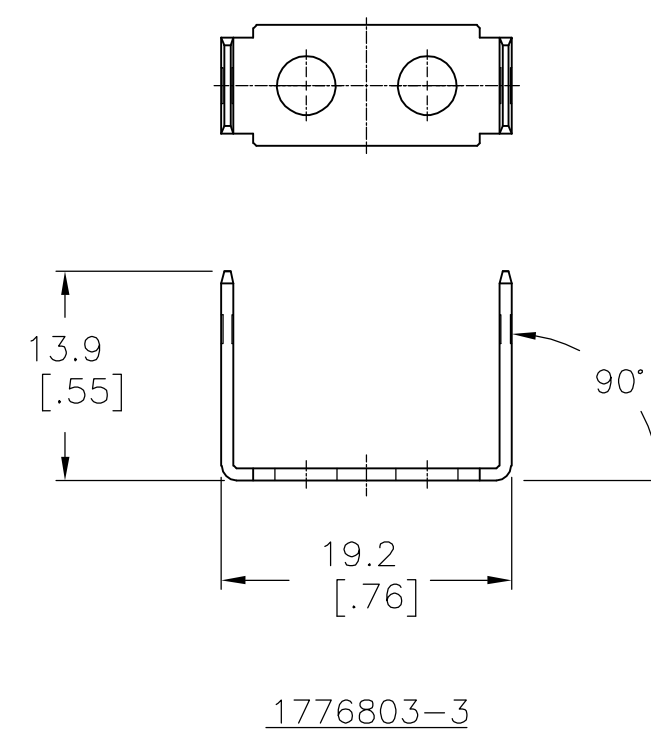
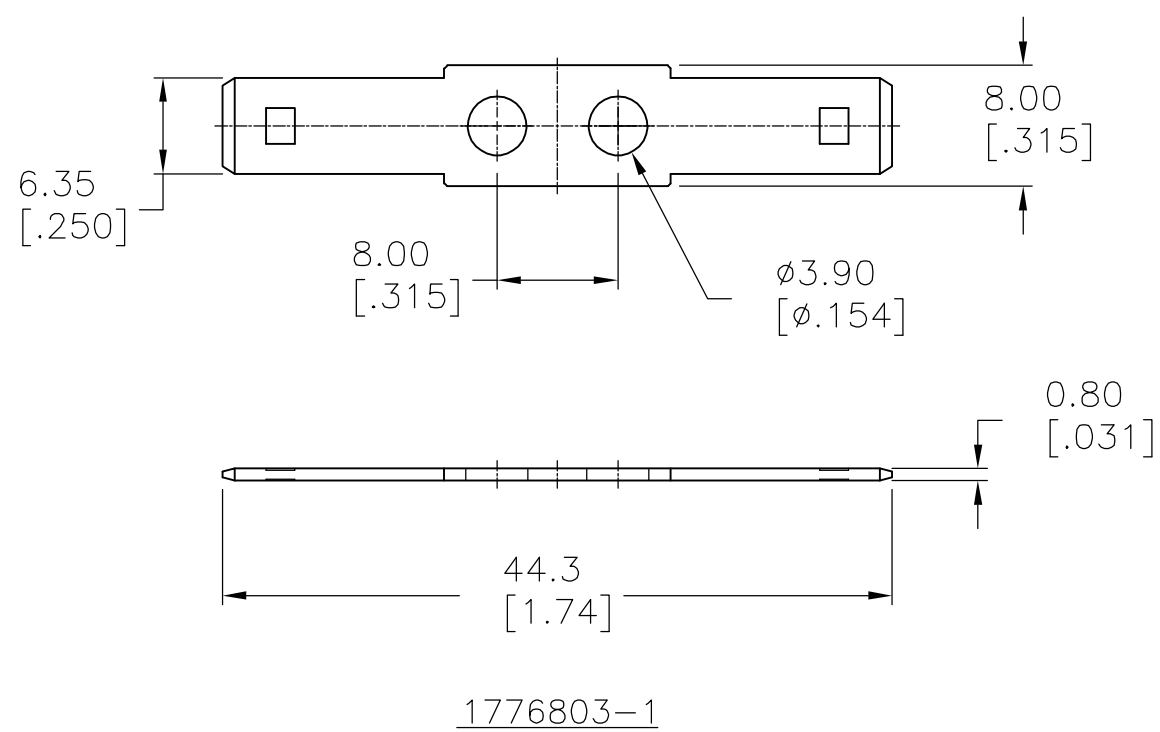

DESCRIPTION	PART NUMBER
90°/45°, DBL SIDED	1776860-4
90°, DBL SIDED	1776860-3
45°, DBL SIDED	1776860-2
FLAT, DBL SIDED	1776860-1

THIS DRAWING IS A CONTROLLED DOCUMENT.		DWN	S SCHLEGEL	6/20/06	Tyco Electronics Corporation Harrisburg, PA 17105-3608				
DIMENSIONS: mm [INCHES]		CHK	S YODER	6/20/06					
TOLERANCES UNLESS OTHERWISE SPECIFIED:		APVD	S YODER	6/20/06					
0 PLC ± - 1 PLC ± 0.3 2 PLC ± 0.25 3 PLC ± - 4 PLC ± - ANGLES ± 5°		PRODUCT SPEC	NAME			.250 QC TABS, DOUBLE SIDED, 9.5mm DOUBLE ROW			
MATERIAL		FINISH		WEIGHT	SIZE	CAGE CODE	DRAWING NO	RESTRICTED TO	
-		-		-	A2	00779	C=1776860	-	
CUSTOMER DRAWING				SCALE	2:1	SHEET	1 of 1	REV	A1

1776860

A

# Mouser Electronics

Authorized Distributor

Click to View Pricing, Inventory, Delivery & Lifecycle Information:

[TE Connectivity:](#)

[1776860-1](#)