

F97 Series



Resin-Molded Chip, Improved Reliability J-Lead



FEATURES

- Compliant to the RoHS2 directive 2011/65/EU
- Compliant to AEC-Q200
- Improved reliability - FR=0.5%/1000hrs
- SMD J-lead



APPLICATIONS

- Automotive electronics (Engine ECU)
- Industrial equipment

CASE DIMENSIONS: millimeters (inches)

Code	EIA Code	EIA Metric	L	W ₁	W ₂	H	S
A	1206	3216-18	3.20 ± 0.20 (0.126 ± 0.008)	1.60 ± 0.20 (0.063 ± 0.008)	1.20 ± 0.10 (0.047 ± 0.004)	1.60 ± 0.20 (0.063 ± 0.008)	0.80 ± 0.20 (0.031 ± 0.008)
B	1210	3528-21	3.50 ± 0.20 (0.126 ± 0.008)	2.80 ± 0.20 (0.110 ± 0.008)	2.20 ± 0.10 (0.087 ± 0.004)	1.90 ± 0.20 (0.075 ± 0.008)	0.80 ± 0.20 (0.031 ± 0.008)
C	2312	6032-27	6.00 ± 0.20 (0.236 ± 0.008)	3.20 ± 0.20 (0.126 ± 0.008)	2.20 ± 0.10 (0.087 ± 0.004)	2.50 ± 0.20 (0.098 ± 0.008)	1.30 ± 0.20 (0.051 ± 0.008)
N	2917	7343-30	7.30 ± 0.20 (0.287 ± 0.008)	4.30 ± 0.20 (0.169 ± 0.008)	2.40 ± 0.10 (0.094 ± 0.004)	2.80 ± 0.20 (0.110 ± 0.008)	1.30 ± 0.20 (0.051 ± 0.008)

A, B CASE

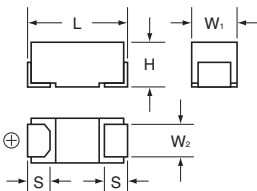

C, N CASE

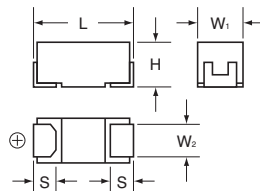

MARKING

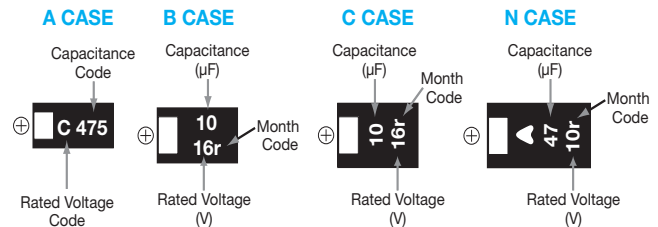

HOW TO ORDER

F97	1C	335	M	A	
Type	Rated Voltage	Capacitance Code	Tolerance	Case Size	Packaging
		pF code: 1st two digits represent significant figures, 3rd digit represents multiplier (number of zeros to follow)	K = ±10% M = ±20%	See table above	See Tape & Reel Packaging Section

TECHNICAL SPECIFICATIONS

Category Temperature Range:	-55 to +125°C
Rated Temperature:	+85°C
Capacitance Tolerance:	±20%, ±10% at 120Hz
Dissipation Factor:	Refer to next page
ESR 100kHz:	Refer to next page
Leakage Current:	After 1 minute's application of rated voltage, leakage current at 20°C is not more than 0.01CV or 0.5µA, whichever is greater. After 1 minute's application of rated voltage, leakage current at 85°C is not more than 0.1CV or 5µA, whichever is greater. After 1 minute's application of derated voltage, leakage current at 125°C is not more than 0.125CV or 6.3µA, whichever is greater.
Capacitance Change By Temperature	+15% Max. at +125°C +10% Max. at +85°C -10% Max. at -55°C

F97 Series



Resin-Molded Chip, Improved Reliability J-Lead

CAPACITANCE AND RATED VOLTAGE RANGE (LETTER DENOTES CASE SIZE)

Capacitance		Rated Voltage					
μF	Code	6.3V (0J)	10V (1A)	16V (1C)	20V (1D)	25V (1E)	35V (1V)
0.33	334						A
0.47	474						A
0.68	684				A	A	A
1.0	105			A	A	A	B
1.5	155			A	A		B
2.2	225		A	A	A	B	B
3.3	335	A	A	A	B	B	C
4.7	475	A	A/B	A/B	A/B	C	C
6.8	685	A/B	B	B	C	C	N
10	106		A/B	A/B/C	C	C/N	N
15	156	B	B	A/C	N	N	
22	226	A/B	A/B	B/C/N	C/N	N	
33	336	A/C	B/C/N	B/C/N			
47	476	B/C	B/C/N	C/N			
68	686	N	N				
100	107	N	C				
150	157	C					

Released ratings

Please contact to your local AVX sales office when these series are being designed in your application.

Voltage vs Temperature Rating

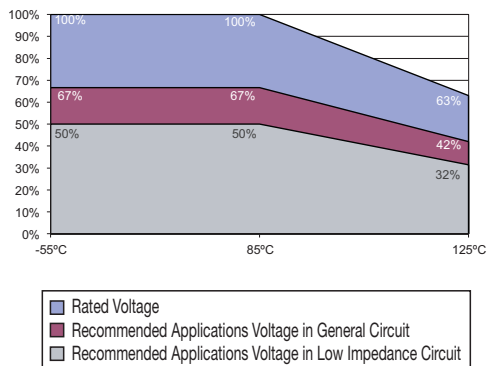

F97 Series



Resin-Molded Chip, Improved Reliability J-Lead

RATINGS & PART NUMBER REFERENCE

AVX Part No.	Case Size	Capacitance (µF)	Rated Voltage (V)	DCL (µA)	DF @ 120Hz (%)	ESR @ 100kHz (Ω)	*1 ΔC/C (%)	MSL
6.3 Volt								
F970J335#AA	A	3.3	6.3	0.5	4	4.5	*	3
F970J475#AA	A	4.7	6.3	0.5	6	4.0	*	3
F970J685#AA	A	6.8	6.3	0.5	6	3.5	*	3
F970J685#BA	B	6.8	6.3	0.5	6	2.5	*	3
F970J156#BA	B	15	6.3	0.9	6	2.0	*	3
F970J226#AA	A	22	6.3	1.4	12	2.5	*	3
F970J226#BA	B	22	6.3	1.4	8	1.9	*	3
F970J336#AA	A	33	6.3	2.1	12	2.5	*	3
F970J336#CC	C	33	6.3	2.1	6	1.1	*	3
F970J476#BA	B	47	6.3	3.0	8	1.0	*	3
F970J476#CC	C	47	6.3	3.0	6	0.9	*	3
F970J686#NC	N	68	6.3	4.3	6	0.6	*	3
F970J107#NC	N	100	6.3	6.3	8	0.6	*	3
F970J157#CC	C	150	6.3	9.5	12	0.7	*	3
10 Volt								
F971A225#AA	A	2.2	10	0.5	4	5.0	*	3
F971A335#AA	A	3.3	10	0.5	4	4.5	*	3
F971A475#AA	A	4.7	10	0.5	6	4.0	*	3
F971A475#BA	B	4.7	10	0.5	6	2.8	*	3
F971A685#BA	B	6.8	10	0.7	6	2.5	*	3
F971A106#AA	A	10	10	1.0	6	3.0	*	3
F971A106#BA	B	10	10	1.0	6	2.0	*	3
F971A156#BA	B	15	10	1.5	6	2.0	*	3
F971A226#AA	A	22	10	2.2	15	3.0	*	3
F971A226#BA	B	22	10	2.2	8	1.9	*	3
F971A336#BA	B	33	10	3.3	8	1.9	*	3
F971A336#CC	C	33	10	3.3	6	1.1	*	3
F971A336#NC	N	33	10	3.3	6	0.7	*	3
F971A476#BA	B	47	10	4.7	10	1.0	*	3
F971A476#CC	C	47	10	4.7	8	0.9	*	3
F971A476#NC	N	47	10	4.7	6	0.7	*	3
F971A686#NC	N	68	10	6.8	6	0.6	*	3
F971A107#CC	C	100	10	10.0	10	0.7	*	3
16 Volt								
F971C105#AA	A	1	16	0.5	4	7.5	*	3
F971C155#AA	A	1.5	16	0.5	4	6.3	*	3
F971C225#AA	A	2.2	16	0.5	4	5.0	*	3
F971C335#AA	A	3.3	16	0.5	4	4.5	*	3
F971C475#AA	A	4.7	16	0.8	8	4.0	*	3
F971C475#BA	B	4.7	16	0.8	6	2.8	*	3
F971C685#BA	B	6.8	16	1.1	6	2.5	*	3
F971C106#AA	A	10	16	1.6	8	3.5	*	3
F971C106#BA	B	10	16	1.6	6	2.1	*	3
F971C106#CC	C	10	16	1.6	6	1.5	*	3

#: "M" for ±20% tolerance, "K" for ±10% tolerance.

Moisture Sensitivity Level (MSL) is defined according to J-STD-020.

1: ΔC/C Marked ""

Item	All Case (%)
Damp Heat	±10
Temperature cycles	±5
Resistance soldering heat	±5
Surge	±5
Endurance	±10
Load Humidity	±10

AVX Part No.	Case Size	Capacitance (µF)	Rated Voltage (V)	DCL (µA)	DF @ 120Hz (%)	ESR @ 100kHz (Ω)	*1 ΔC/C (%)	MSL
F971C156#AA	A	15	16	2.4	12	3.5	±10	3
F971C156#CC	C	15	16	2.4	6	1.2	*	3
F971C226#BA	B	22	16	3.5	8	1.9	*	3
F971C226#CC	C	22	16	3.5	8	1.1	*	3
F971C226#NC	N	22	16	3.5	6	0.7	*	3
F971C336#BA	B	33	16	5.3	10	2.1	*	3
F971C336#CC	C	33	16	5.3	8	1.1	*	3
F971C336#NC	N	33	16	5.3	6	0.7	*	3
F971C476#CC	C	47	16	7.5	10	1.1	*	3
F971C476#NC	N	47	16	7.5	8	0.7	*	3
20 Volt								
F971D684#AA	A	0.68	20	0.5	4	7.6	*	3
F971D105#AA	A	1	20	0.5	4	7.5	*	3
F971D155#AA	A	1.5	20	0.5	4	6.7	*	3
F971D225#AA	A	2.2	20	0.5	6	6.3	*	3
F971D335#BA	B	3.3	20	0.7	4	3.1	*	3
F971D475#AA	A	4.7	20	0.9	8	4.0	*	3
F971D475#BA	B	4.7	20	0.9	6	2.8	*	3
F971D685#CC	C	6.8	20	1.4	6	1.8	*	3
F971D106#CC	C	10	20	2.0	6	1.5	*	3
F971D156#NC	N	15	20	3.0	6	0.7	*	3
F971D226#CC	C	22	20	4.4	8	1.1	*	3
F971D226#NC	N	22	20	4.4	6	0.7	*	3
25 Volt								
F971E684#AA	A	0.68	25	0.5	4	7.6	*	3
F971E105#AA	A	1	25	0.5	4	7.5	*	3
F971E225#BA	B	2.2	25	0.6	4	3.8	*	3
F971E335#BA	B	3.3	25	0.8	4	3.5	*	3
F971E475#CC	C	4.7	25	1.2	6	1.8	*	3
F971E685#CC	C	6.8	25	1.7	6	1.8	*	3
F971E106#CC	C	10	25	2.5	6	1.6	*	3
F971E106#NC	N	10	25	2.5	6	1.0	*	3
F971E156#NC	N	15	25	3.8	6	0.7	*	3
F971E226#NC	N	22	25	5.5	6	0.7	*	3
35 Volt								
F971V334#AA	A	0.33	35	0.5	4	12.0	*	3
F971V474#AA	A	0.47	35	0.5	4	10.0	*	3
F971V684#AA	A	0.68	35	0.5	4	7.6	*	3
F971V105#BA	B	1	35	0.5	4	4.0	*	3
F971V155#BA	B	1.5	35	0.5	4	4.0	*	3
F971V225#BA	B	2.2	35	0.8	4	3.8	*	3
F971V335#CC	C	3.3	35	1.2	4	2.0	*	3
F971V475#CC	C	4.7	35	1.6	6	1.8	*	3
F971V685#NC	N	6.8	35	2.4	6	1.0	*	3
F971V106#NC	N	10	35	3.5	6	1.0	*	3

QUALIFICATION TABLE

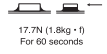
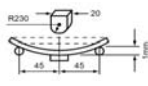
TEST	F97 series (Temperature range -55°C to +125°C)	
	Condition	
Damp Heat (Steady State)	At 85°C, 85% R.H., 1000 hours (No voltage applied) Capacitance Change Refer to page 109 (*1) Dissipation Factor Initial specified value or less Leakage Current 125% or less than the initial specified value	
Load Humidity	After 1000 hour's application of rated voltage in series with a 33Ω resistor at 85°C, 85% R.H., capacitors meet the characteristics requirements table below. Capacitance Change Refer to page 109 (*1) Dissipation Factor 120% or less than the initial specified value Leakage Current 200% of less than the initial specified value	
Temperature Cycles	At -55°C / +125°C, 30 minutes each, 1000 cycles Capacitance Change Refer to page 109 (*1) Dissipation Factor Initial specified value or less Leakage Current Initial specified value or less	
Resistance to Soldering Heat	10 seconds reflow at 260°C, 5 seconds immersion at 260°C. Capacitance Change Refer to page 109 (*1) Dissipation Factor Initial specified value or less Leakage Current Initial specified value or less	
Solderability	After immersing capacitors completely into a solder pot at 245°C for 2 to 3 seconds, more than 3/4 of their electrode area shall remain covered with new solder.	
Surge	After application of surge voltage in series with a 33Ω resistor at the rate of 30 seconds ON, 30 seconds OFF, for 1000 successive test cycles at 85°C, capacitors shall meet the characteristic requirements in the table above. Capacitance Change Refer to page 109 (*1) Dissipation Factor Initial specified value or less Leakage Current Initial specified value or less	
Endurance	After 2000 hours' application of rated voltage in series with a 3Ω resistor at 85°C, or derated voltage in series with a 3Ω resistor at 125°C, capacitors shall meet the characteristic requirements in the table above. Capacitance Change Refer to page 109 (*1) Dissipation Factor Initial specified value or less Leakage Current Initial specified value or less	
Shear Test	After applying the pressure load of 17.7N for 60 seconds horizontally to the center of capacitor side body which has no electrode and has been soldered beforehand on a substrate, there shall be found neither exfoliation nor its sign at the terminal electrode..	
Terminal Strength	Keeping a capacitor surface-mounted on a substrate upside down and supporting the substrate at both of the opposite bottom points 45mm apart from the center of capacitor, the pressure strength is applied with a specified jig at the center of the substrate so that substrate may bend by 1mm as illustrated. Then, there shall be found no remarkable abnormality on the capacitor terminals.	
Failure Rate	0.5% per 1000 hours at 85°C, V _R with 0.1Ω/V series impedance, 60% confidence level.	

AVX SOLID ELECTROLYTE CAPACITOR ROADMAP

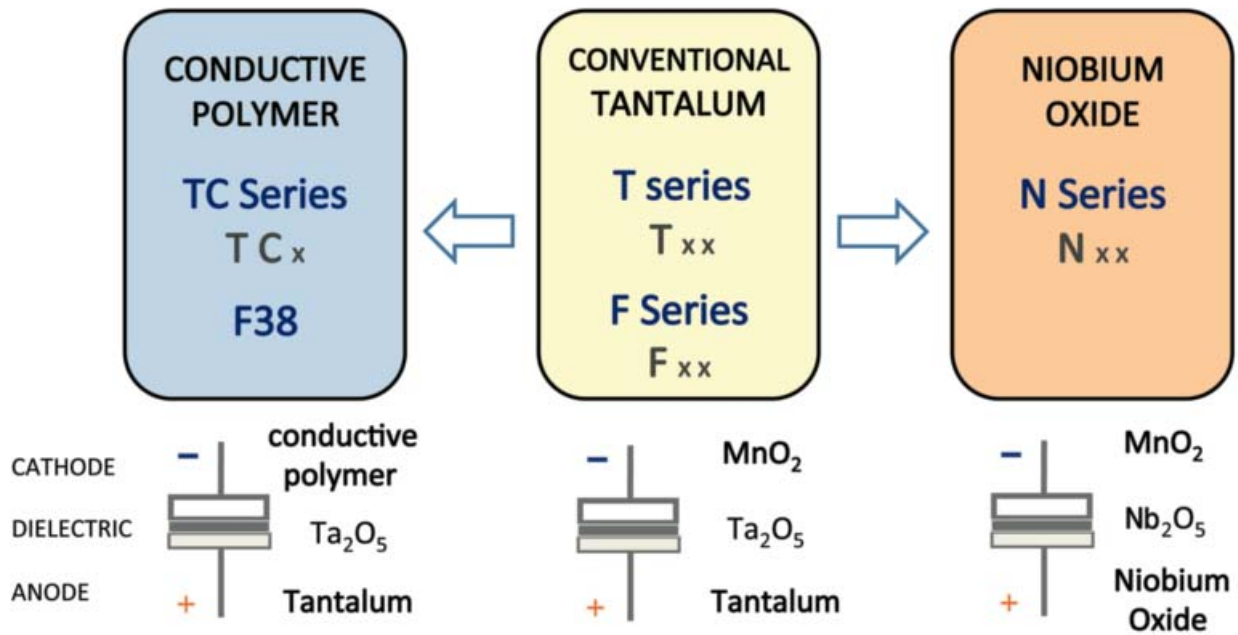

Five Capacitor Construction Styles

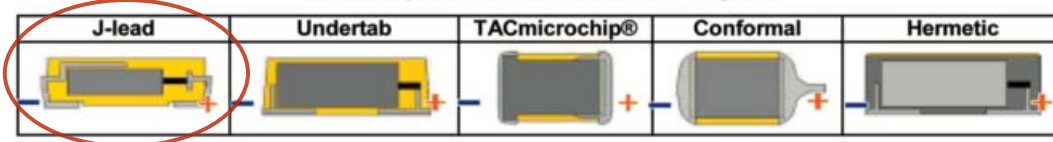

SERIES LINE UP: CONVENTIONAL SMD MnO₂

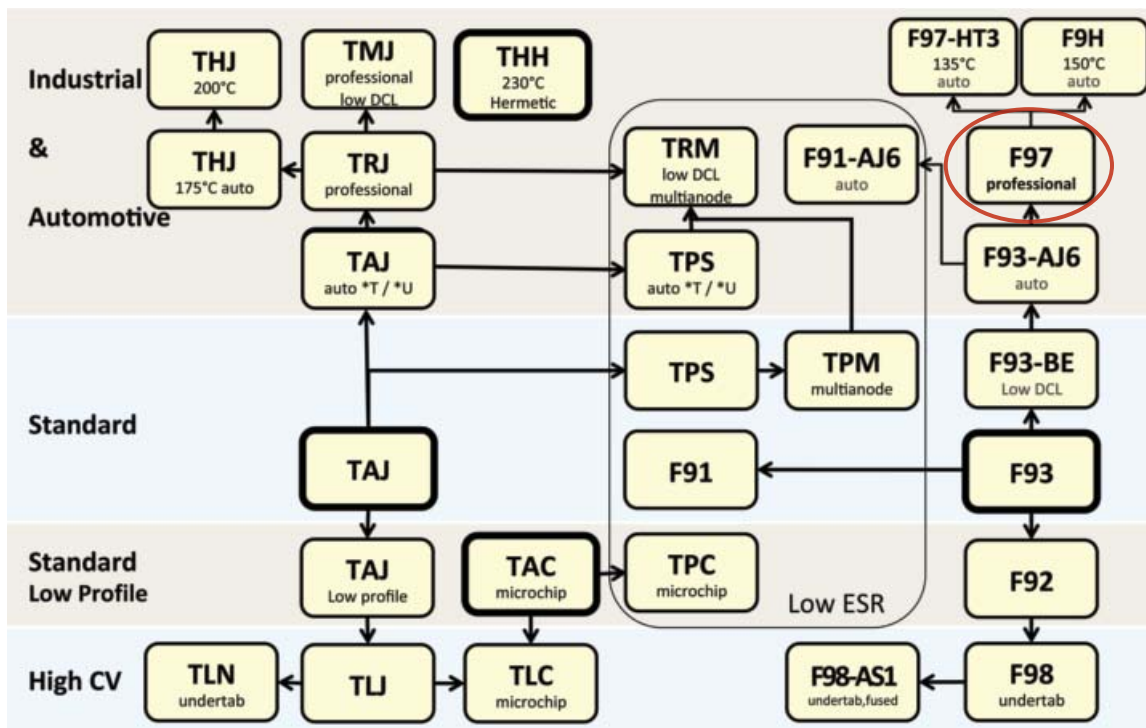

Mouser Electronics

Authorized Distributor

Click to View Pricing, Inventory, Delivery & Lifecycle Information:

AVX:

[F970J336MCA](#) [F971C336MCC](#) [F971D475MBA](#) [F971C226KCC](#) [F971D225KAA](#) [F971E225KBA](#) [F970J225MAA](#)
[F971V684MAA](#) [F971A336KBA](#) [F971C106MBA](#) [F971V225MCC](#) [F971A155MAA](#) [F971V475KCC](#) [F970G686MCC](#)
[F971A226MBA](#) [F971D156MNC](#) [F971V334MAA](#) [F971A686KNC](#) [F970J686MNA](#) [F971E335MBA](#) [F971C106MCC](#)
[F971C105MAA](#) [F970G107MNC](#) [F970J107KNC](#) [F971C106KBA](#) [F971D684MAA](#) [F971C475MAA](#) [F971A156MCC](#)
[F971E105MAA](#) [F971D475MAA](#) [F971A476MNC](#) [F971C226MCC](#) [F971E474MAA](#) [F970J475MAA](#) [F971V105MBA](#)
[F971E684MAA](#) [F971A335KAA](#) [F970G475MAA](#) [F971A336MBA](#) [F970J686MNC](#) [F970J336MCC](#) [F971C336MBA](#)
[F971D106MCC](#) [F971A226MCC](#) [F970J226MAA](#) [F971C156MCC](#) [F971C106MAA](#) [F971E684KAA](#) [F971V155MBA](#)
[F970G156MBA](#) [F970J107MNA](#) [F971D335KBA](#) [F970J107MNC](#) [F971E105KAA](#) [F970J476MBA](#) [F971C336MNC](#)
[F970J336KAA](#) [F971E156MNC](#) [F971C336KCC](#) [F971C335MBA](#) [F970J476MCC](#) [F971C335KAA](#) [F970J685KBA](#)
[F970G106MBA](#) [F971A226MAA](#) [F971D226MCC](#) [F971E106MCC](#) [F971A685KBA](#) [F971V225KBA](#) [F970G686MNC](#)
[F971C475MBA](#) [F970J685KAA](#) [F971V225MBA](#) [F970J476MCA](#) [F971A106MAA](#) [F971E106KCC](#) [F970J476KCC](#)
[F971D225MBA](#) [F971A335MAA](#) [F970J476KBA](#) [F970J335MAA](#) [F971D155KAA](#) [F971D105KAA](#) [F971A156KBA](#)
[F971E685KCC](#) [F971D226KCC](#) [F971C475KAA](#) [F970J476MNC](#) [F970J226MBA](#) [F971A336MNC](#) [F970J685MAA](#)
[F971A336MCC](#) [F971D105MAA](#) [F971V106MNC](#) [F970G335MAA](#) [F971E156KNC](#) [F971A106KAA](#) [F971V335MCC](#)
[F971E106MNC](#) [F970G226MBA](#)