

High Voltage IGBT

IXGH 32N170
IXGT 32N170

$V_{CES} = 1700 \text{ V}$
 $I_{C25} = 75 \text{ A}$
 $V_{CE(sat)} = 3.3 \text{ V}$
 $t_{fi(typ)} = 250 \text{ ns}$

Preliminary Data Sheet

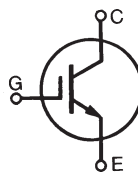

Symbol	Test Conditions	Maximum Ratings	
V_{CES}	$T_J = 25^\circ\text{C to } 150^\circ\text{C}$	1700	V
V_{CGR}	$T_J = 25^\circ\text{C to } 150^\circ\text{C}; R_{GE} = 1 \text{ M}\Omega$	1700	V
V_{GES}	Continuous	± 20	V
V_{GEM}	Transient	± 30	V
I_{C25}	$T_C = 25^\circ\text{C}$	75	A
I_{C90}	$T_C = 90^\circ\text{C}$	32	A
I_{CM}	$T_C = 25^\circ\text{C}, 1 \text{ ms}$	200	A
SSOA (RBSOA)	$V_{GE} = 15 \text{ V}, T_{VJ} = 125^\circ\text{C}, R_G = 5 \Omega$ Clamped inductive load	$I_{CM} = 90$ @ $0.8 V_{CES}$	A
P_C	$T_C = 25^\circ\text{C}$	350	W
T_J		-55 ... +150	$^\circ\text{C}$
T_{JM}		150	$^\circ\text{C}$
T_{stg}		-55 ... +150	$^\circ\text{C}$
Maximum Lead temperature for soldering 1.6 mm (0.062 in.) from case for 10 s		300	$^\circ\text{C}$
Maximum Tab temperature for soldering SMD devices for 10 s		260	$^\circ\text{C}$
M_d	Mounting torque (M3)	1.13/10Nm/lb.in.	
Weight		TO-247 AD	6 g
		TO-268	4 g

TO-268 (IXGT)

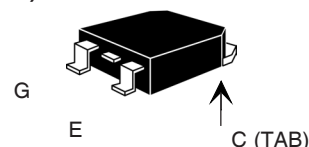

TO-247 AD (IXGH)

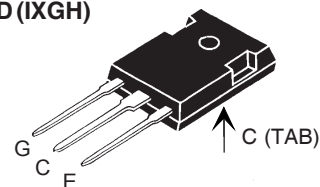

G = Gate, C = Collector,
E = Emitter, TAB = Collector

Features

- International standard packages
JEDEC TO-268 and
JEDEC TO-247 AD
- High current handling capability
- MOS Gate turn-on
- drive simplicity
- Rugged NPT structure
- Molding epoxies meet UL 94 V-0
flammability classification

Applications

- Capacitor discharge & pulser circuits
- AC motor speed control
- DC servo and robot drives
- DC choppers
- Uninterruptible power supplies (UPS)
- Switched-mode and resonant-mode
power supplies

Advantages

- High power density
- Suitable for surface mounting
- Easy to mount with 1 screw,
(isolated mounting screw hole)

Symbol	Test Conditions	Characteristic Values ($T_J = 25^\circ\text{C}$, unless otherwise specified)		
		min.	typ.	max.
BV_{CES}	$I_C = 250 \mu\text{A}, V_{GE} = 0 \text{ V}$	1700		V
$V_{GE(th)}$	$I_C = 250 \mu\text{A}, V_{CE} = V_{GE}$	3.0		V
I_{CES}	$V_{CE} = 0.8 \cdot V_{CES}$ $V_{GE} = 0 \text{ V}$	$T_J = 25^\circ\text{C}$		50 μA
		$T_J = 125^\circ\text{C}$		1 mA
I_{GES}	$V_{CE} = 0 \text{ V}, V_{GE} = \pm 20 \text{ V}$			$\pm 100 \text{ nA}$
$V_{CE(sat)}$	$I_C = I_{C90}, V_{GE} = 15 \text{ V}$	$T_J = 25^\circ\text{C}$	2.5	3.3 V
		$T_J = 125^\circ\text{C}$	3.0	V

Symbol	Test Conditions	Characteristic Values ($T_J = 25^\circ\text{C}$, unless otherwise specified)		
		min.	typ.	max.
g_{fs}	$I_C = I_{C90}$; $V_{CE} = 10\text{ V}$, Pulse test, $t \leq 300\ \mu\text{s}$, duty cycle $\leq 2\%$	22	30	S
$I_{C(ON)}$	$V_{GE} = 10\text{ V}$, $V_{CE} = 10\text{ V}$		120	A
C_{ies}	$V_{CE} = 25\text{ V}$, $V_{GE} = 0\text{ V}$, $f = 1\text{ MHz}$		3500	pF
C_{oes}			165	pF
C_{res}			40	pF
Q_g	$I_C = I_{C90}$, $V_{GE} = 15\text{ V}$, $V_{CE} = 0.5 V_{CES}$		155	nC
Q_{ge}			30	nC
Q_{gc}			51	nC
$t_{d(on)}$	Inductive load, $T_J = 25^\circ\text{C}$ $I_C = I_{C90}$, $V_{GE} = 15\text{ V}$ $V_{CE} = 0.6 V_{CES}$, $R_G = R_{off} = 2.7\ \Omega$		45	ns
t_{ri}			38	ns
$t_{d(off)}$			270	500 ns
t_{fi}			250	500 ns
E_{off}			11	20 mJ
$t_{d(on)}$	Inductive load, $T_J = 125^\circ\text{C}$ $I_C = I_{C90}$, $V_{GE} = 15\text{ V}$ $V_{CE} = 0.6 V_{CES}$, $R_G = R_{off} = 2.7\ \Omega$		48	ns
t_{ri}			42	ns
E_{on}			6.0	mJ
$t_{d(off)}$			360	ns
t_{fi}			560	ns
E_{off}		14	mJ	
R_{thJC}				0.35 K/W
R_{thCK}	(TO-247)		0.25	K/W

Min Recommended Footprint

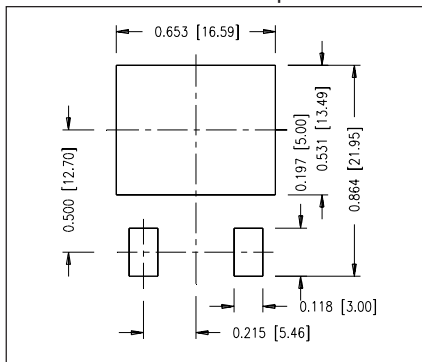

TO-247 AD Outline

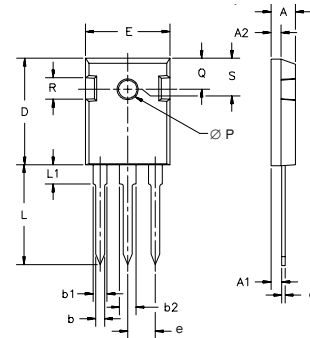

Dim.	Millimeter		Inches	
	Min.	Max.	Min.	Max.
A	4.7	5.3	.185	.209
A ₁	2.2	2.54	.087	.102
A ₂	2.2	2.6	.059	.098
b	1.0	1.4	.040	.055
b ₁	1.65	2.13	.065	.084
b ₂	2.87	3.12	.113	.123
C	.4	.8	.016	.031
D	20.80	21.46	.819	.845
E	15.75	16.26	.610	.640
e	5.20	5.72	0.205	0.225
L	19.81	20.32	.780	.800
L1		4.50		.177
∅P	3.55	3.65	.140	.144
Q	5.89	6.40	0.232	0.252
R	4.32	5.49	.170	.216
S	6.15	BSC	.242	BSC

TO-268 Outline

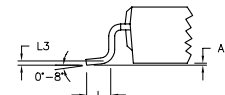
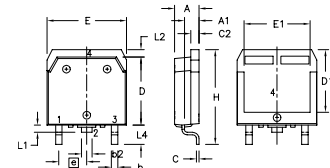

Dim.	Millimeter		Inches	
	Min.	Max.	Min.	Max.
A	4.9	5.1	.193	.201
A ₁	2.7	2.9	.106	.114
A ₂	.02	.25	.001	.010
b	1.15	1.45	.045	.057
b ₂	1.9	2.1	.75	.83
C	.4	.65	.016	.026
D	13.80	14.00	.543	.551
E	15.85	16.05	.624	.632
E ₁	13.3	13.6	.524	.535
e	5.45	BSC	.215	BSC
H	18.70	19.10	.736	.752
L	2.40	2.70	.094	.106
L1	1.20	1.40	.047	.055
L2	1.00	1.15	.039	.045
L3		0.25 BSC		.010 BSC
L4	3.80	4.10	.150	.161

IXYS reserves the right to change limits, test conditions, and dimensions.

IXYS MOSFETs and IGBTs are covered by one or more of the following U.S. patents:

4,835,592 4,881,106 5,017,508 5,049,961 5,187,117 5,486,715 6,306,728B1 6,259,123B1 6,306,728B1
4,850,072 4,931,844 5,034,796 5,063,307 5,237,481 5,381,025 6,404,065B1 6,162,665 6,534,343 6,583,505

Fig. 1. Output Characteristics @ 25 Deg. C

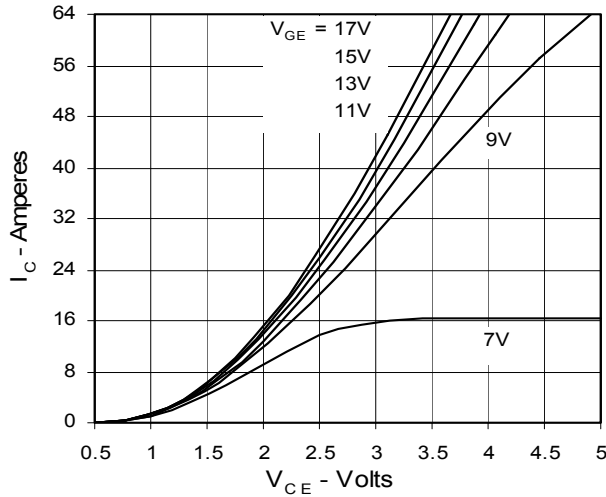

Fig. 2. Extended Output Characteristics @ 25 deg. C

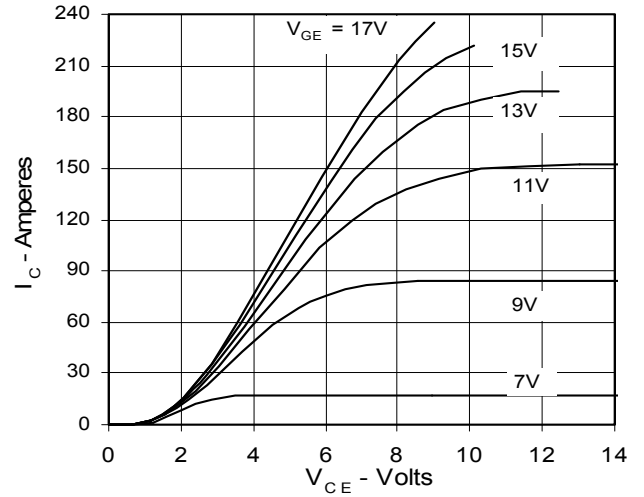

Fig. 3. Output Characteristics @ 125 Deg. C

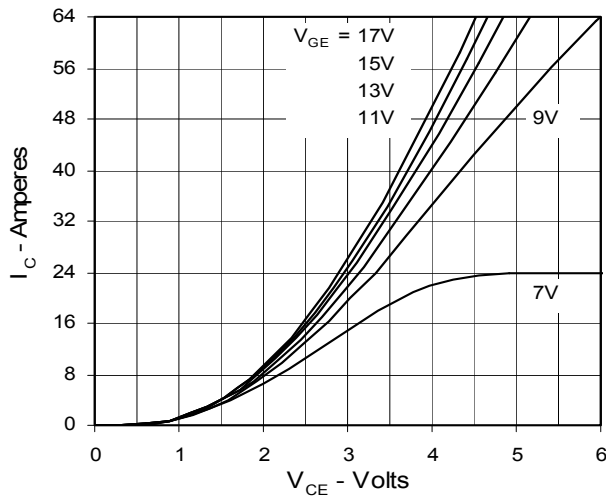

Fig. 4. Dependence of $V_{CE(sat)}$ on Temperature

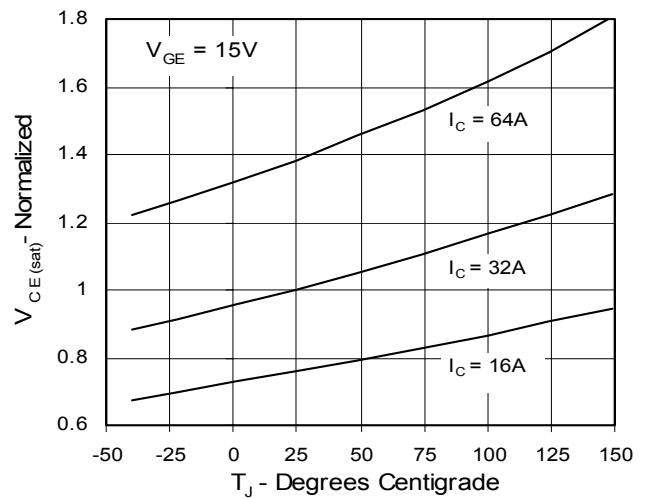

Fig. 5. Collector-to-Emitter Voltage vs. Gate-to-Emitter voltage

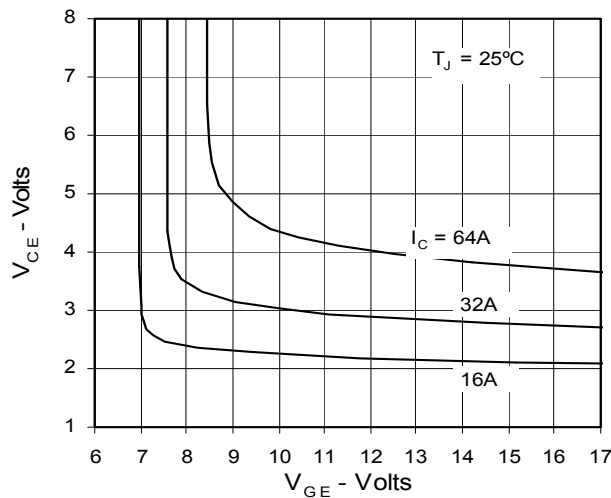

Fig. 6. Input Admittance

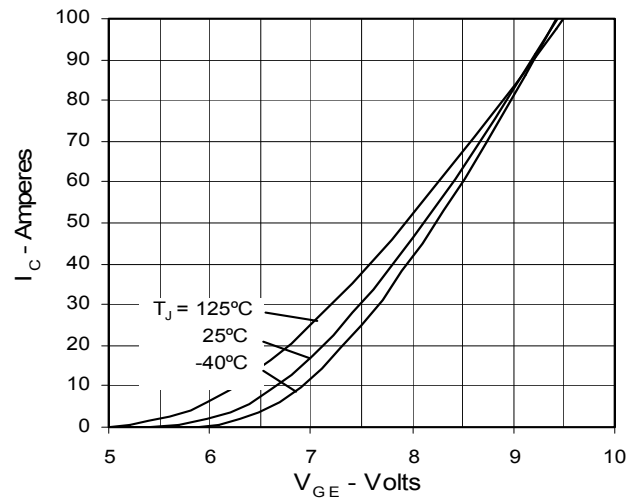

Fig. 7. Transconductance

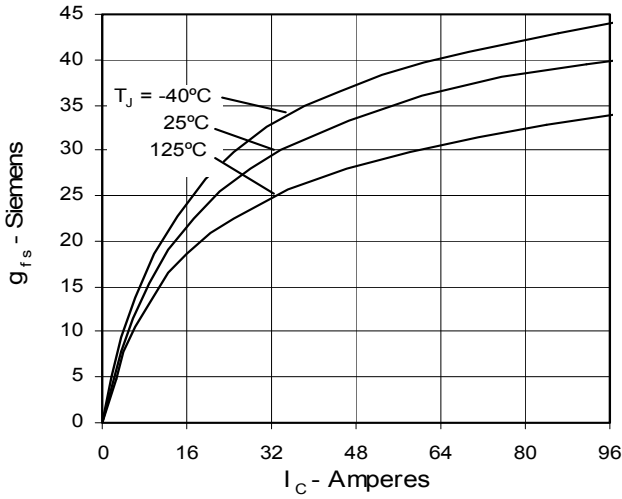

Fig. 8. Dependence of E_{off} on R_G

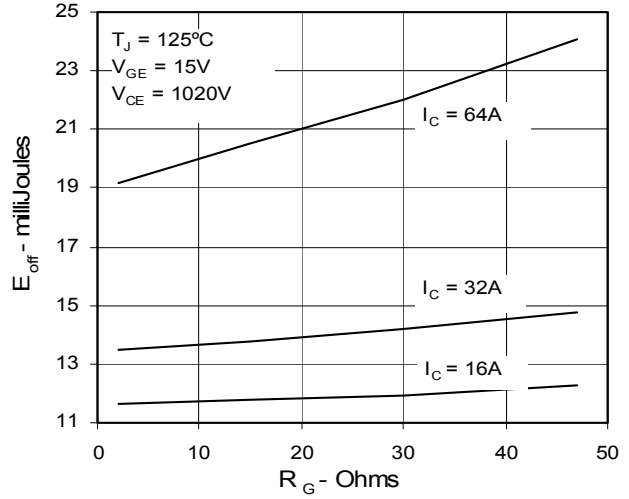

Fig. 9. Dependence of E_{off} on I_C

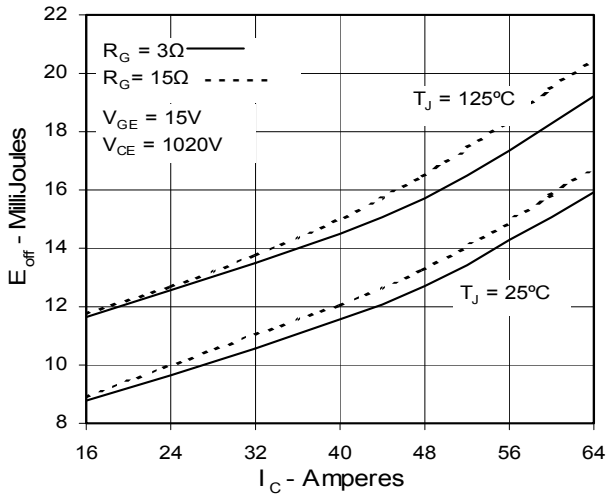

Fig. 10. Dependence of E_{off} on Temperature

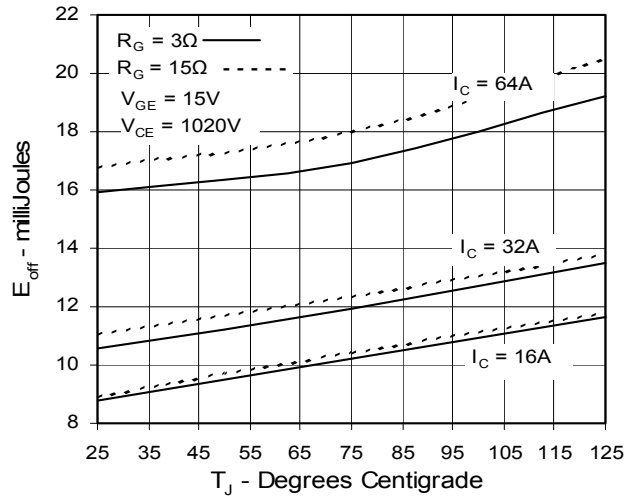

Fig. 11. Gate Charge

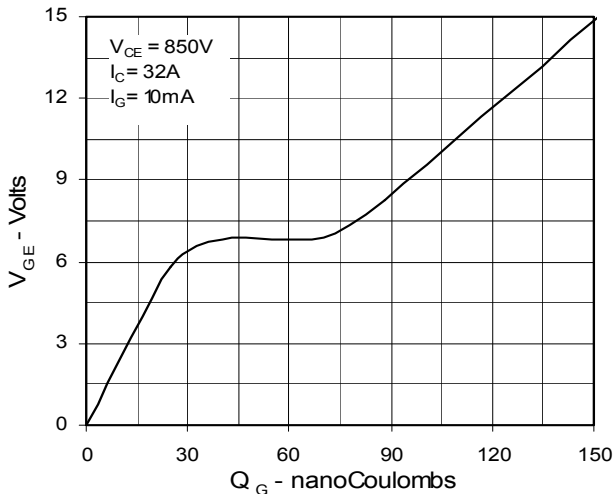
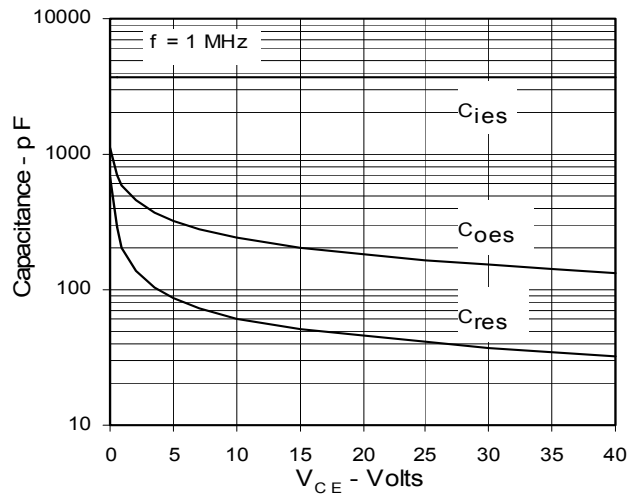

Fig. 12. Capacitance



IXYS reserves the right to change limits, test conditions, and dimensions.

IXYS MOSFETs and IGBTs are covered by one or more of the following U.S. patents: 4,835,592 4,881,106 5,017,508 5,049,961 5,187,117 5,486,715 6,306,728B1 6,259,123B1 6,306,728B1 4,850,072 4,931,844 5,034,796 5,063,307 5,237,481 5,381,025 6,404,065B1 6,162,665 6,534,343 6,583,505

Fig. 13. Maximum Transient Thermal Resistance

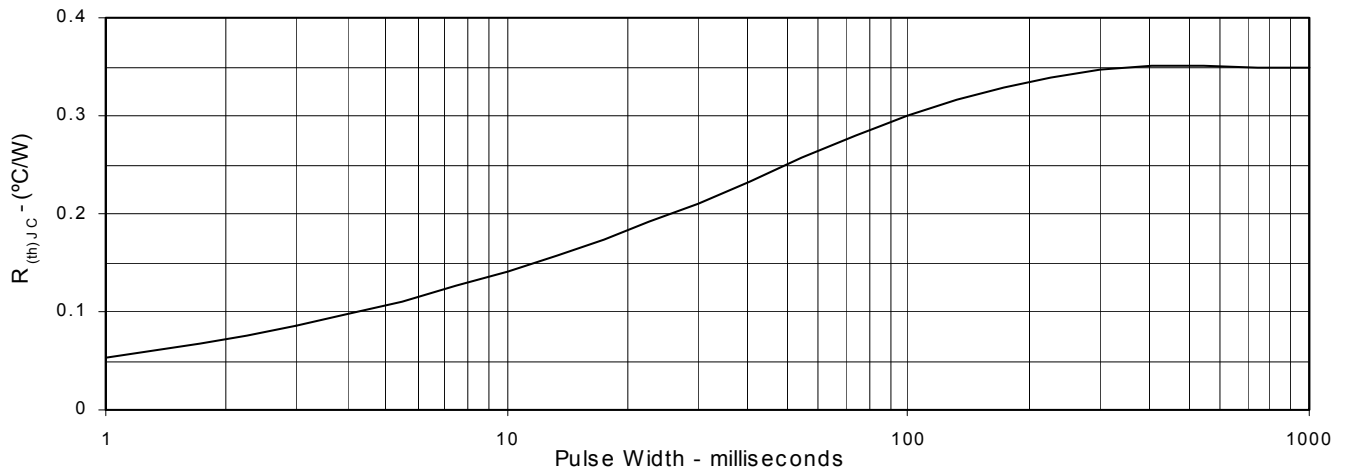

Mouser Electronics

Authorized Distributor

Click to View Pricing, Inventory, Delivery & Lifecycle Information:

[IXYS:](#)

[IXGH32N170](#) [IXGT32N170](#)