

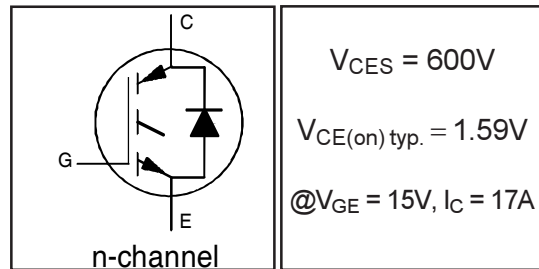
# IRG4BC30FDPbF

INSULATED GATE BIPOLAR TRANSISTOR WITH ULTRAFAST  
 SOFT RECOVERY DIODE

Fast CoPack IGBT

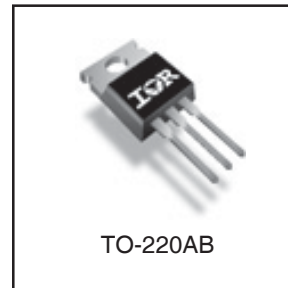
## Features

- Fast: Optimized for medium operating frequencies (1-5 kHz in hard switching, >20kHz in resonant mode).
- Generation 4 IGBT design provides tighter parameter distribution and higher efficiency than Generation 3
- IGBT co-packaged with HEXFRED™ ultrafast, ultra-soft-recovery anti-parallel diodes for use in bridge configurations
- Industry standard TO-220AB package
- Lead-Free



## Benefits

- Generation -4 IGBT's offer highest efficiencies available
- IGBT's optimized for specific application conditions
- HEXFRED diodes optimized for performance with IGBT's. Minimized recovery characteristics require less/no snubbing
- Designed to be a "drop-in" replacement for equivalent industry-standard Generation 3 IR IGBT's



## Absolute Maximum Ratings

	Parameter	Max.	Units
$V_{CES}$	Collector-to-Emitter Voltage	600	V
$I_C @ T_C = 25^\circ\text{C}$	Continuous Collector Current	31	A
$I_C @ T_C = 100^\circ\text{C}$	Continuous Collector Current	17	
$I_{CM}$	Pulsed Collector Current ①	124	
$I_{LM}$	Clamped Inductive Load Current ②	124	
$I_F @ T_C = 100^\circ\text{C}$	Diode Continuous Forward Current	12	
$I_{FM}$	Diode Maximum Forward Current	120	
$V_{GE}$	Gate-to-Emitter Voltage	$\pm 20$	V
$P_D @ T_C = 25^\circ\text{C}$	Maximum Power Dissipation	100	W
$P_D @ T_C = 100^\circ\text{C}$	Maximum Power Dissipation	42	
$T_J$	Operating Junction and Storage Temperature Range	-55 to +150	$^\circ\text{C}$
$T_{STG}$			
	Mounting Torque, 6-32 or M3 Screw.	10 lbf•in (1.1 N•m)	

## Thermal Resistance

	Parameter	Min.	Typ.	Max.	Units
$R_{\theta JC}$	Junction-to-Case - IGBT	-----	-----	1.2	$^\circ\text{C}/\text{W}$
$R_{\theta JC}$	Junction-to-Case - Diode	-----	-----	2.5	
$R_{\theta CS}$	Case-to-Sink, flat, greased surface	-----	0.50	-----	
$R_{\theta JA}$	Junction-to-Ambient, typical socket mount	-----	-----	80	
$Wt$	Weight	-----	2 (0.07)	-----	g (oz)

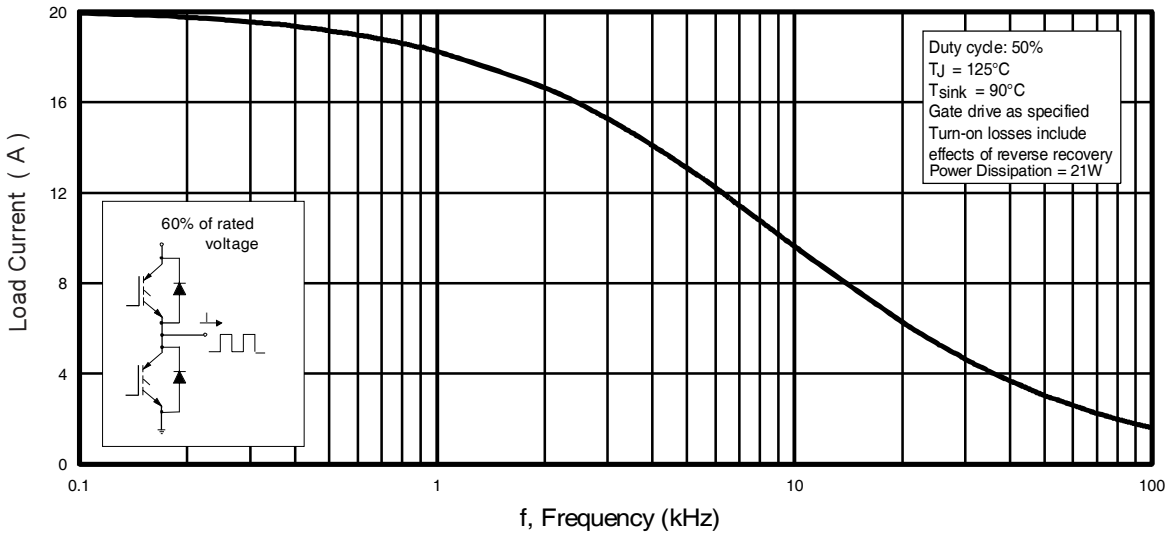
# IRG4BC30FDPbF

## Electrical Characteristics @ T<sub>J</sub> = 25°C (unless otherwise specified)

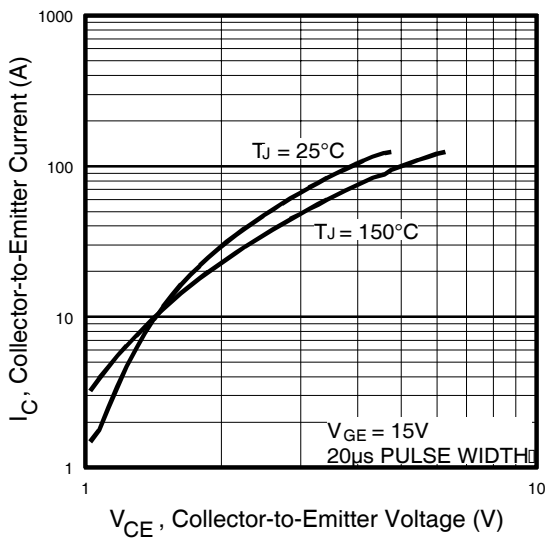
	Parameter	Min.	Typ.	Max.	Units	Conditions
V <sub>(BR)CES</sub>	Collector-to-Emitter Breakdown Voltage <sup>③</sup>	600	----	----	V	V <sub>GE</sub> = 0V, I <sub>C</sub> = 250μA
ΔV <sub>(BR)CES</sub> /ΔT <sub>J</sub>	Temperature Coeff. of Breakdown Voltage	----	0.69	----	V/°C	V <sub>GE</sub> = 0V, I <sub>C</sub> = 1.0mA
V <sub>CE(on)</sub>	Collector-to-Emitter Saturation Voltage	----	1.59	1.8	V	I <sub>C</sub> = 17A, V <sub>GE</sub> = 15V
		----	1.99	----		I <sub>C</sub> = 31A
		----	1.70	----		I <sub>C</sub> = 17A, T <sub>J</sub> = 150°C
V <sub>GE(th)</sub>	Gate Threshold Voltage	3.0	----	6.0		V <sub>CE</sub> = V <sub>GE</sub> , I <sub>C</sub> = 250μA
ΔV <sub>GE(th)</sub> /ΔT <sub>J</sub>	Temperature Coeff. of Threshold Voltage	----	-11	----	mV/°C	V <sub>CE</sub> = V <sub>GE</sub> , I <sub>C</sub> = 250μA
g <sub>fe</sub>	Forward Transconductance <sup>④</sup>	6.1	10	----	S	V <sub>CE</sub> = 100V, I <sub>C</sub> = 17A
I <sub>CES</sub>	Zero Gate Voltage Collector Current	----	----	250	μA	V <sub>GE</sub> = 0V, V <sub>CE</sub> = 600V
		----	----	2500		V <sub>GE</sub> = 0V, V <sub>CE</sub> = 600V, T <sub>J</sub> = 150°C
V <sub>FM</sub>	Diode Forward Voltage Drop	----	1.4	1.7	V	I <sub>C</sub> = 12A
		----	1.3	1.6		I <sub>C</sub> = 12A, T <sub>J</sub> = 150°C
I <sub>GES</sub>	Gate-to-Emitter Leakage Current	----	----	±100	nA	V <sub>GE</sub> = ±20V

## Switching Characteristics @ T<sub>J</sub> = 25°C (unless otherwise specified)

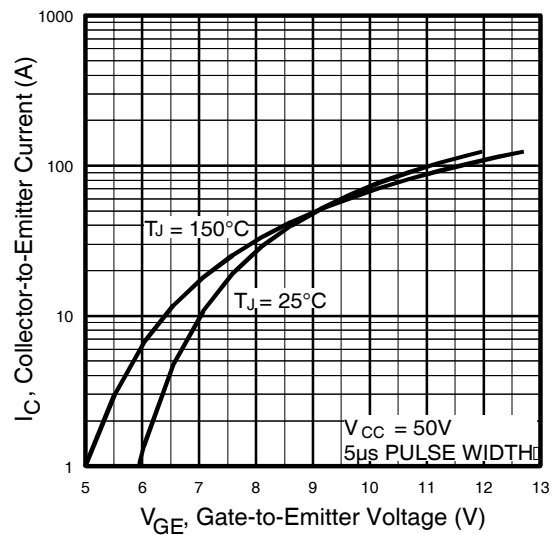
	Parameter	Min.	Typ.	Max.	Units	Conditions	
Q <sub>g</sub>	Total Gate Charge (turn-on)	----	51	77	nC	I <sub>C</sub> = 17A	
Q <sub>ge</sub>	Gate - Emitter Charge (turn-on)	----	7.9	12		V <sub>CC</sub> = 400V	
Q <sub>gc</sub>	Gate - Collector Charge (turn-on)	----	19	28		V <sub>GE</sub> = 15V	
t <sub>d(on)</sub>	Turn-On Delay Time	----	42	----	ns	T <sub>J</sub> = 25°C	
t <sub>r</sub>	Rise Time	----	26	----		I <sub>C</sub> = 17A, V <sub>CC</sub> = 480V	
t <sub>d(off)</sub>	Turn-Off Delay Time	----	230	350		V <sub>GE</sub> = 15V, R <sub>G</sub> = 23Ω	
t <sub>f</sub>	Fall Time	----	160	230	mJ	Energy losses include "tail" and diode reverse recovery.	
E <sub>on</sub>	Turn-On Switching Loss	----	0.63	----		See Fig. 9, 10, 11, 18	
E <sub>off</sub>	Turn-Off Switching Loss	----	1.39	----			
E <sub>ts</sub>	Total Switching Loss	----	2.02	3.9	mJ	T <sub>J</sub> = 150°C, See Fig. 9, 10, 11, 18	
t <sub>d(on)</sub>	Turn-On Delay Time	----	42	----			I <sub>C</sub> = 17A, V <sub>CC</sub> = 480V
t <sub>r</sub>	Rise Time	----	27	----			V <sub>GE</sub> = 15V, R <sub>G</sub> = 23Ω
t <sub>d(off)</sub>	Turn-Off Delay Time	----	310	----	mJ	Energy losses include "tail" and diode reverse recovery.	
t <sub>f</sub>	Fall Time	----	310	----			
E <sub>ts</sub>	Total Switching Loss	----	3.2	----			
L <sub>E</sub>	Internal Emitter Inductance	----	7.5	----	nH	Measured 5mm from package	
C <sub>ies</sub>	Input Capacitance	----	1100	----	pF	V <sub>GE</sub> = 0V	
C <sub>oes</sub>	Output Capacitance	----	74	----		V <sub>CC</sub> = 30V	
C <sub>res</sub>	Reverse Transfer Capacitance	----	14	----		f = 1.0MHz	
t <sub>rr</sub>	Diode Reverse Recovery Time	----	42	60	ns	T <sub>J</sub> = 25°C See Fig. 14	
		----	80	120		T <sub>J</sub> = 125°C	
I <sub>rr</sub>	Diode Peak Reverse Recovery Current	----	3.5	6.0	A	T <sub>J</sub> = 25°C See Fig. 15	
		----	5.6	10		T <sub>J</sub> = 125°C	
Q <sub>rr</sub>	Diode Reverse Recovery Charge	----	80	180	nC	T <sub>J</sub> = 25°C See Fig. 16	
		----	220	600		T <sub>J</sub> = 125°C	
di <sub>(rec)</sub> M/dt	Diode Peak Rate of Fall of Recovery During t <sub>b</sub>	----	180	----	A/μs	T <sub>J</sub> = 25°C See Fig. 17	
		----	120	----		T <sub>J</sub> = 125°C	



**Fig. 1 - Typical Load Current vs. Frequency**  
 (Load Current =  $I_{\text{RMS}}$  of fundamental)

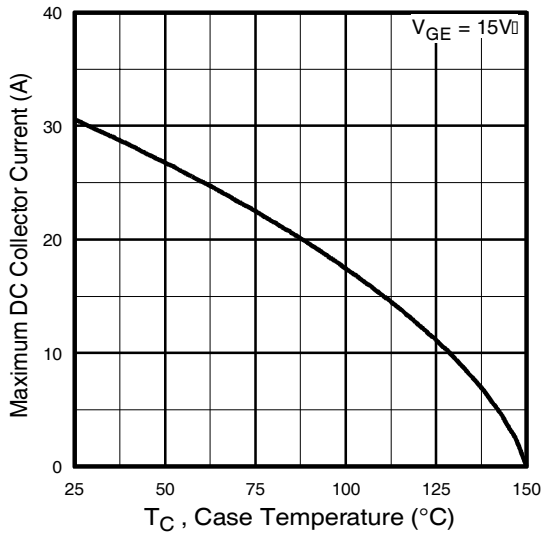


**Fig. 2 - Typical Output Characteristics**  
[www.irf.com](http://www.irf.com)

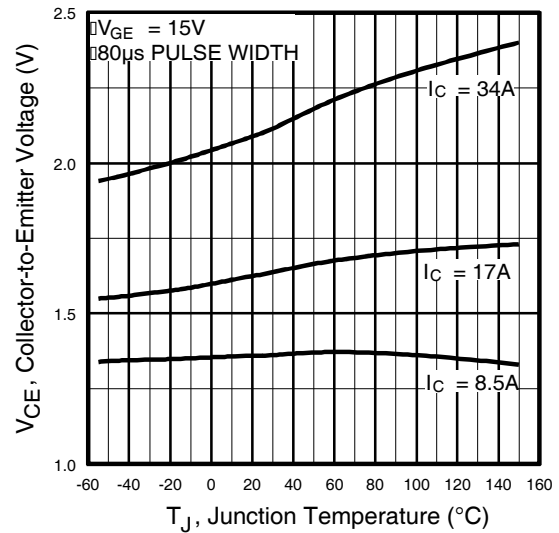


**Fig. 3 - Typical Transfer Characteristics**

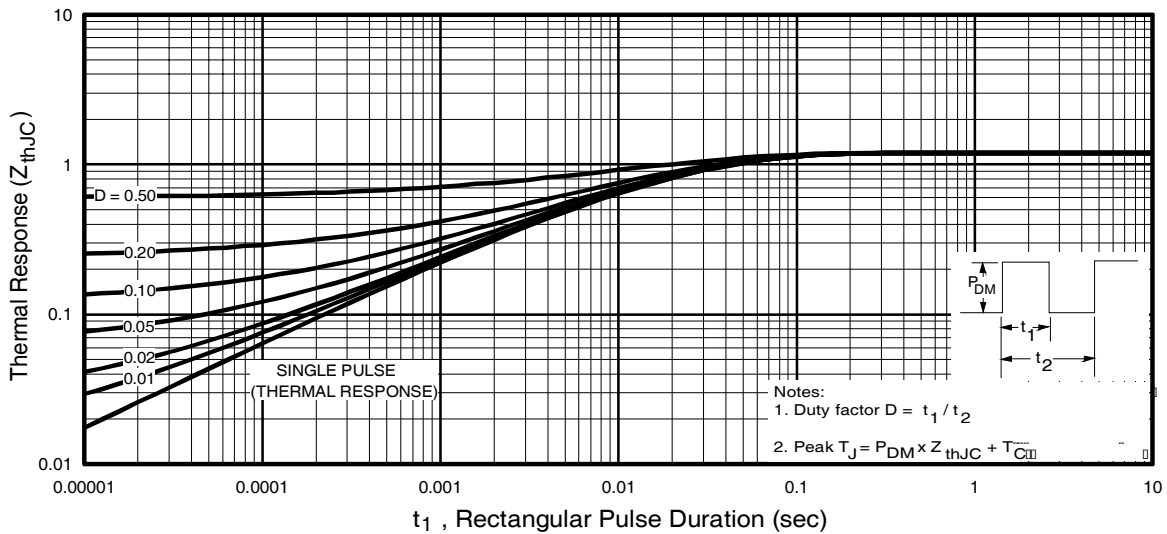
# IRG4BC30FDPbF



**Fig. 4 - Maximum Collector Current vs. Case Temperature**

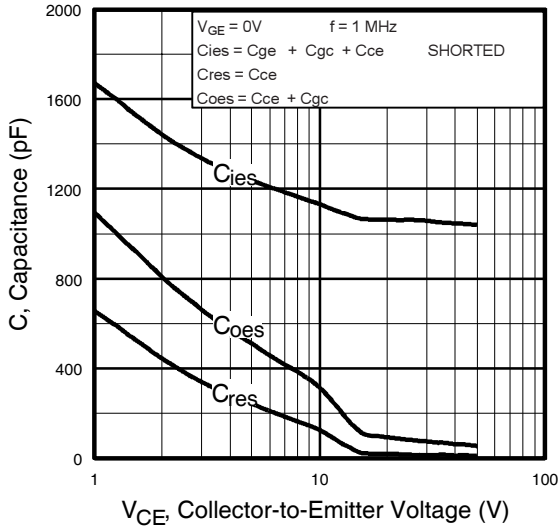


**Fig. 5 - Typical Collector-to-Emitter Voltage vs. Junction Temperature**

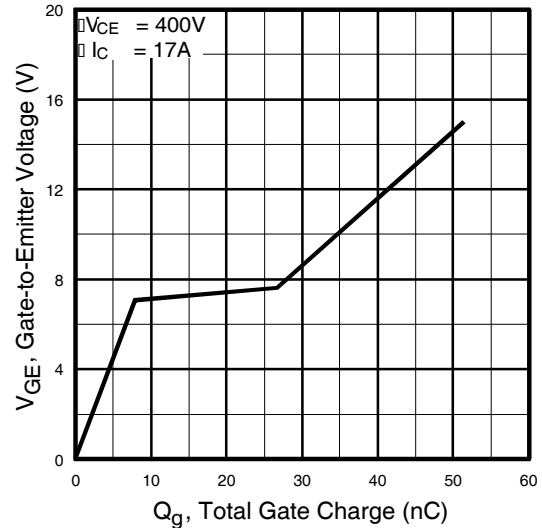


**Fig. 6 - Maximum Effective Transient Thermal Impedance, Junction-to-Case**

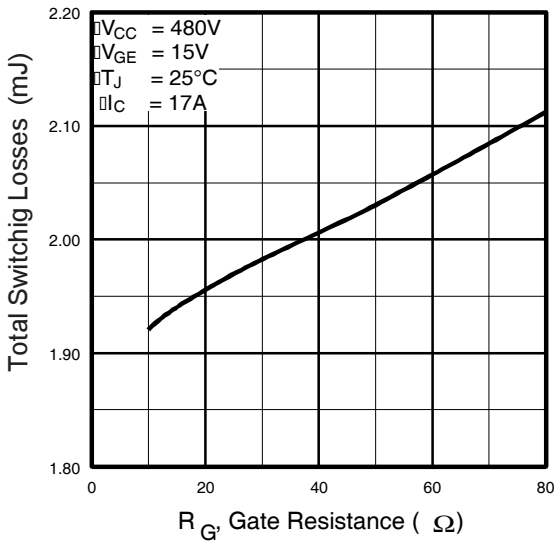
# IRG4BC30FDPbF



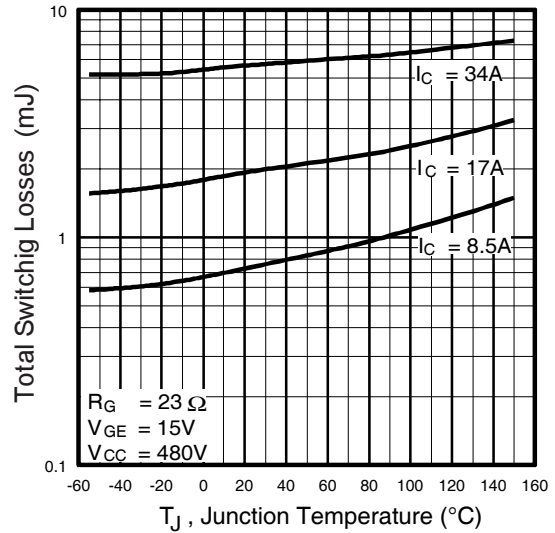
**Fig. 7** - Typical Capacitance vs. Collector-to-Emitter Voltage



**Fig. 8** - Typical Gate Charge vs. Gate-to-Emitter Voltage

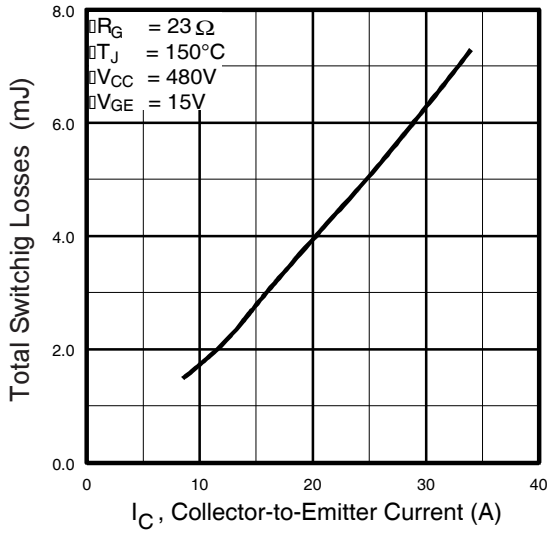


**Fig. 9** - Typical Switching Losses vs. Gate Resistance

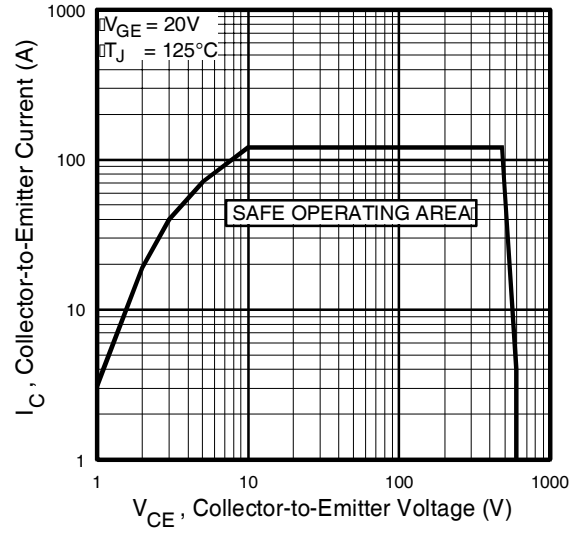


**Fig. 10** - Typical Switching Losses vs. Junction Temperature

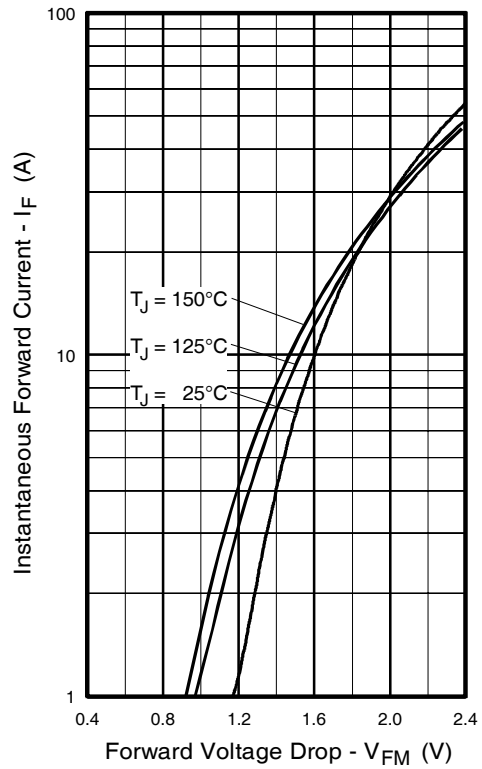
# IRG4BC30FDPbF



**Fig. 11** - Typical Switching Losses vs. Collector-to-Emitter Current



**Fig. 12** - Turn-Off SOA



**Fig. 13** - Maximum Forward Voltage Drop vs. Instantaneous Forward Current

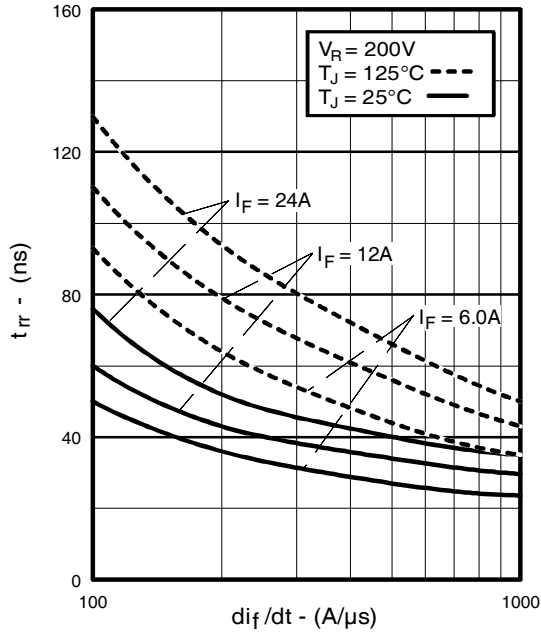


Fig. 14 - Typical Reverse Recovery vs.  $di_f/dt$

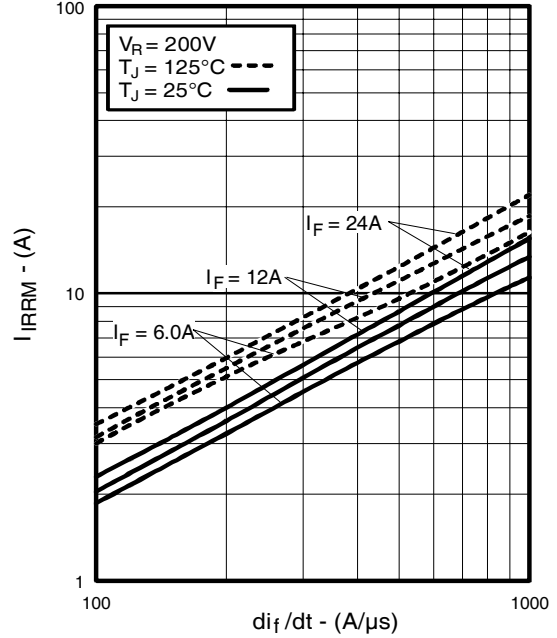


Fig. 15 - Typical Recovery Current vs.  $di_f/dt$

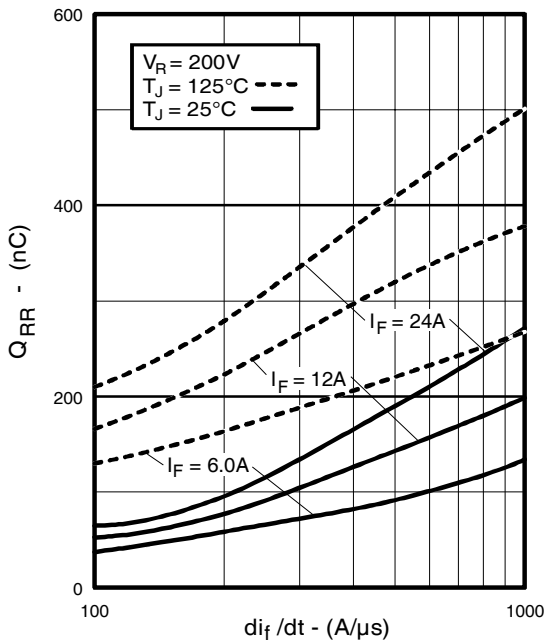


Fig. 16 - Typical Stored Charge vs.  $di_f/dt$

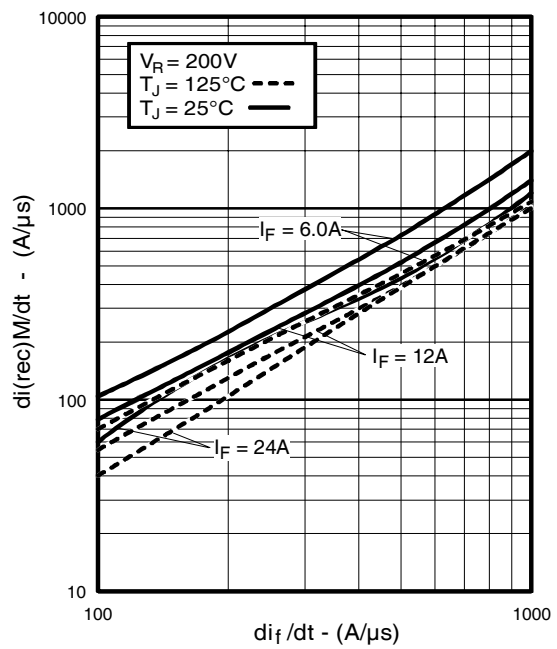
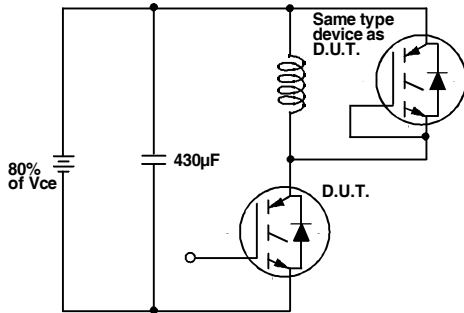
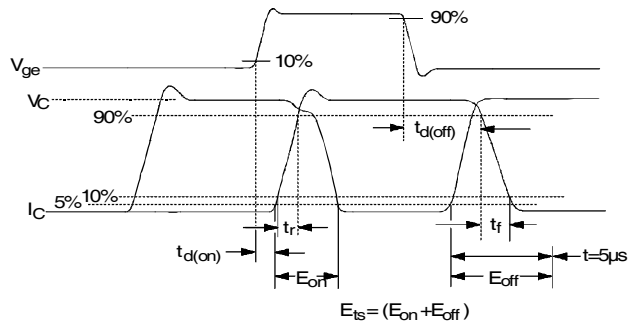


Fig. 17 - Typical  $di_{(rec)M}/dt$  vs.  $di_f/dt$

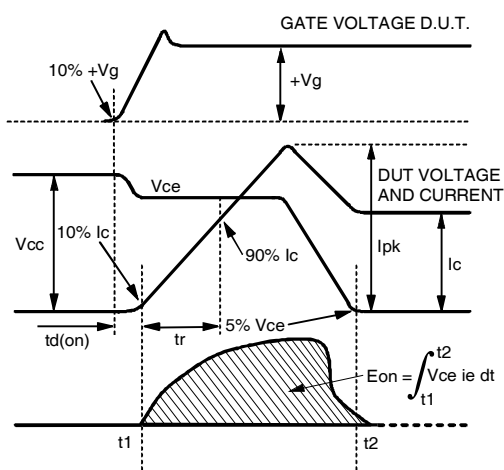
# IRG4BC30FDPbF



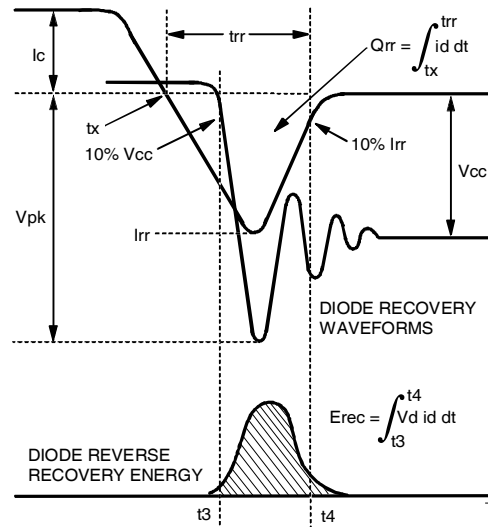
**Fig. 18a** - Test Circuit for Measurement of  $I_{LM}$ ,  $E_{on}$ ,  $E_{off}(\text{diode})$ ,  $t_{rr}$ ,  $Q_{rr}$ ,  $I_{rr}$ ,  $t_{d(on)}$ ,  $t_r$ ,  $t_{d(off)}$ ,  $t_f$



**Fig. 18b** - Test Waveforms for Circuit of Fig. 18a, Defining  $E_{off}$ ,  $t_{d(off)}$ ,  $t_f$



**Fig. 18c** - Test Waveforms for Circuit of Fig. 18a, Defining  $E_{on}$ ,  $t_{d(on)}$ ,  $t_r$



**Fig. 18d** - Test Waveforms for Circuit of Fig. 18a, Defining  $E_{rec}$ ,  $t_{rr}$ ,  $Q_{rr}$ ,  $I_{rr}$



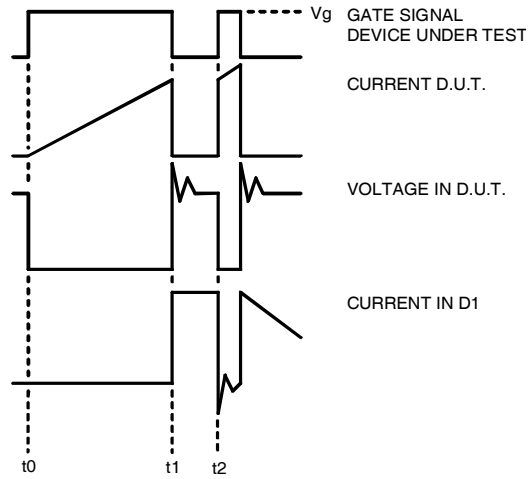


Figure 18e. Macro Waveforms for Figure 18a's Test Circuit

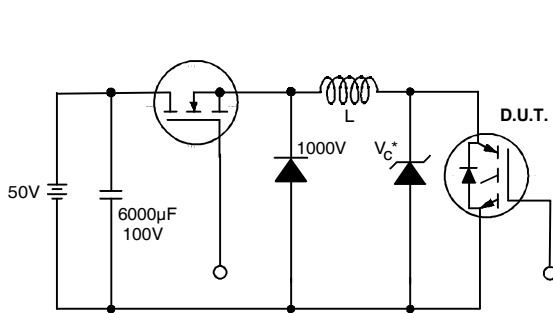
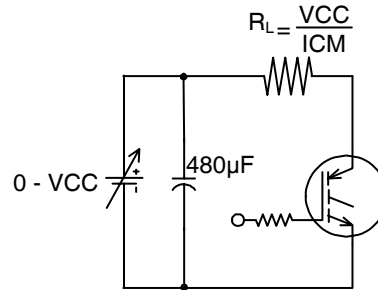


Figure 19. Clamped Inductive Load Test Circuit



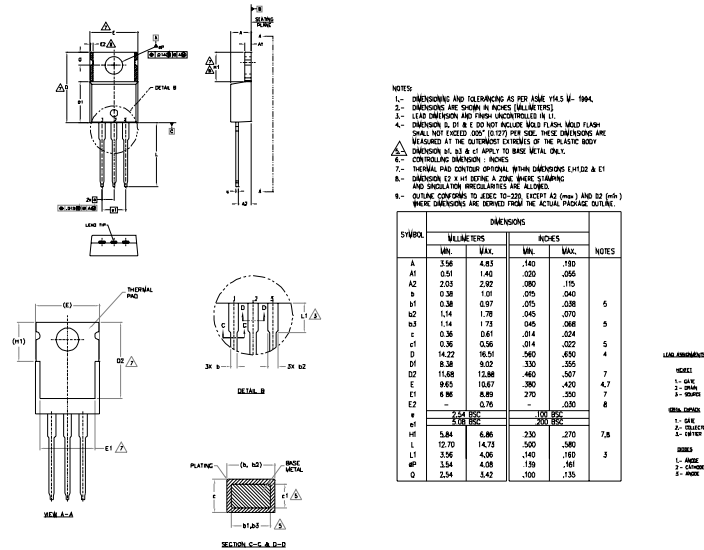
Pulsed Collector Current Test Circuit

Figure 20. Pulsed Collector Current Test Circuit

# IRG4BC30FDPbF

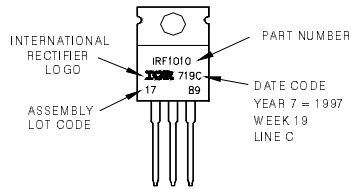
International  
**IR** Rectifier

TO-220AB Package Outline (Dimensions are shown in millimeters (inches))



## TO-220AB Part Marking Information

EXAMPLE: THIS IS AN IRF1010  
LOT CODE 1789  
ASSEMBLED ON WW 19, 1 1997  
IN THE ASSEMBLY LINE 'C'  
**Note:** "P" in assembly line position indicates "Lead-Free"



**Note:** For the most current drawing please refer to IR website at <http://www.irf.com/package/>

### Notes:

- ① Repetitive rating:  $V_{GE}=20V$ ; pulse width limited by maximum junction temperature (figure 20)
- ②  $V_{CC}=80\%(V_{CES})$ ,  $V_{GE}=20V$ ,  $L=10\mu H$ ,  $R_G = 23\Omega$  (figure 19)
- ③ Pulse width  $\leq 80\mu s$ ; duty factor  $\leq 0.1\%$ .
- ④ Pulse width  $5.0\mu s$ , single shot.

Data and specifications subject to change without notice.

International  
**IR** Rectifier

**IR WORLD HEADQUARTERS:** 233 Kansas St., El Segundo, California 90245, USA Tel: (310) 252-7105  
TAC Fax: (310) 252-7903

Visit us at [www.irf.com](http://www.irf.com) for sales contact information. 01/2010

# Mouser Electronics

Authorized Distributor

Click to View Pricing, Inventory, Delivery & Lifecycle Information:

[Infineon:](#)

[IRG4BC30FDPBF](#)