

TPS799 200-mA, Low-Quiescent Current, Ultralow Noise, High-PSRR Low-Dropout Linear Regulator

1 Features

- 200-mA Low-Dropout Regulator With EN
- Multiple Output Voltage Versions Available:
 - Fixed Outputs of 1.2 V to 4.5 V Using Innovative Factory EEPROM Programming
 - Adjustable Outputs from 1.20 V to 6.5 V
- Inrush Current Protection with EN Toggle
- Low I_Q : 40 μ A
- High PSRR: 66 dB at 1 kHz
- Stable with a Low-ESR, 2- μ F Typical Output Capacitance
- Excellent Load and Line Transient Response
- 2% Overall Accuracy (Load, Line, and Temperature)
- Very Low Dropout: 100 mV
- Package: 5-Bump, Thin, 1-mm x 1.37-mm DSBGA

2 Applications

- Cellular Phones
- Wireless LAN, *Bluetooth*[®]
- VCOs, RF
- Handheld Organizers, PDAs

3 Description

The TPS799 family of low-dropout (LDO), low-power linear regulators offers excellent ac performance with very low ground current. High power-supply rejection ratio (PSRR), low noise, fast start-up, and excellent line and load transient response are provided while consuming a very low 40- μ A (typical) ground current.

The TPS799 is stable with ceramic capacitors and uses an advanced BiCMOS fabrication process to yield a dropout voltage of typically 100 mV at a 200-mA output. The TPS799 uses a precision voltage reference and feedback loop to achieve an overall accuracy of 2% over all load, line, process, and temperature variations. The TPS799 features inrush current protection when the EN toggle is used to start the device, immediately clamping the current.

All devices are fully specified over the temperature range of $T_J = -40^\circ\text{C}$ to 125°C , and offered in a low-profile, die-sized ball grid array (DSBGA) package, ideal for wireless handsets and WLAN cards.

Device Information⁽¹⁾

| PART NUMBER | PACKAGE | BODY SIZE (NOM) |
|-------------|-----------|-------------------|
| TPS799 | SOT (5) | 2.90 mm x 1.60 mm |
| | SON (6) | 2.00 x 2.00 mm |
| | DSBGA (5) | 1.57 mm x 1.20 mm |

(1) For all available packages, see the orderable addendum at the end of the data sheet.

Typical Application Circuit Fixed Voltage Versions

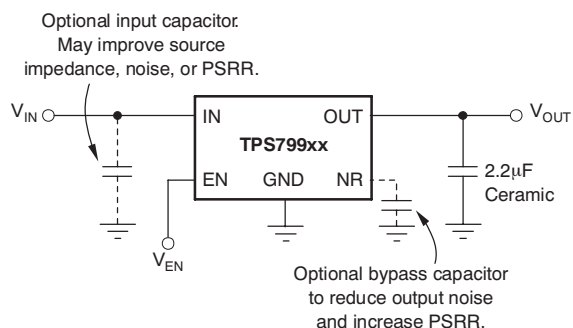

Typical Application Circuit Adjustable Voltage Version

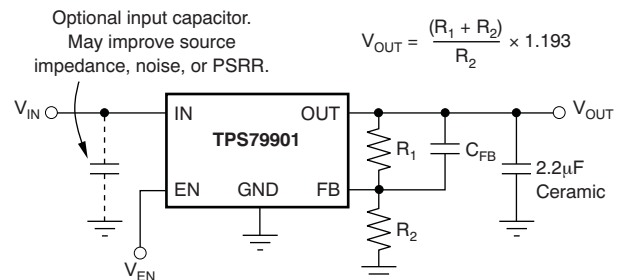

Table of Contents

| | |
|--|--|
| 1 Features 1 2 Applications 1 3 Description 1 4 Revision History 2 5 Pin Configuration and Functions 3 5.1 Fixed Voltage Versions 3 5.2 Adjustable Voltage Versions 3 6 Specifications 5 6.1 Absolute Maximum Ratings 5 6.2 ESD Ratings 5 6.3 Recommended Operating Conditions 5 6.4 Thermal Information 5 6.5 Electrical Characteristics 6 6.6 Typical Characteristics 7 7 Detailed Description 12 7.1 Overview 12 7.2 Functional Block Diagram 12 7.3 Feature Description 13 | 7.4 Device Functional Modes 13 8 Application and Implementation 14 8.1 Application Information 14 8.2 Typical Applications 14 8.3 Do's and Don'ts 16 9 Power Supply Recommendations 16 10 Layout 16 10.1 Layout Guidelines 16 10.2 Layout Example 17 10.3 Thermal Information 17 11 Device and Documentation Support 18 11.1 Device Support 18 11.2 Documentation Support 18 11.3 Trademarks 18 11.4 Electrostatic Discharge Caution 18 11.5 Glossary 18 12 Mechanical, Packaging, and Orderable Information 18 |
|--|--|

4 Revision History

NOTE: Page numbers for previous revisions may differ from page numbers in the current version.

| Changes from Revision J (August 2010) to Revision K | Page |
|--|------|
| • Added <i>ESD Ratings</i> table, <i>Feature Description</i> section, <i>Device Functional Modes</i> , <i>Application and Implementation</i> section, <i>Power Supply Recommendations</i> section, <i>Layout</i> section, <i>Device and Documentation Support</i> section, and <i>Mechanical, Packaging, and Orderable Information</i> section | 1 |
| • Changed Features list | 1 |
| • Changed Description section..... | 1 |
| • Changed figure on front page; replaced device pinouts with application circuits..... | 1 |
| • Changed Pin Configuration and Functions section; updated table format, renamed pin packages to meet new standards | 3 |
| • Changed "free-air" to "junction" temperature in condition statement for <i>Absolute Maximum Ratings</i> | 5 |
| • Changed <i>free-air</i> to <i>junction</i> in Recommended Operating Conditions table conditions..... | 5 |
| • Added thermal information for additional device packages | 5 |

| Changes from Revision I (November 2007) to Revision J | Page |
|---|------|
| • Replaced the <i>Dissipation Ratings</i> table with the <i>Thermal Information</i> table | 5 |

5 Pin Configuration and Functions

5.1 Fixed Voltage Versions

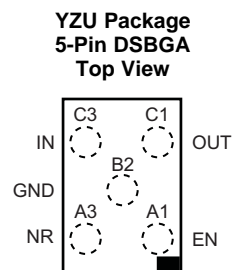
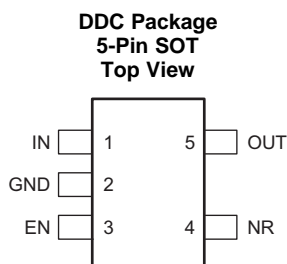

DRV Package
6-Pin SON With Exposed Thermal Pad
Top View

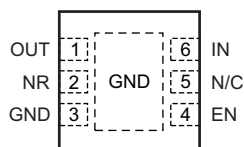

5.2 Adjustable Voltage Versions

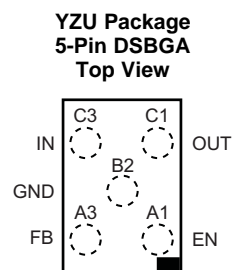
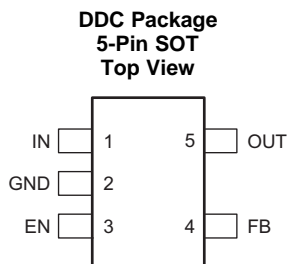

DRV Package
6-Pin SON With Exposed Thermal Pad
Top View

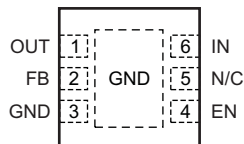

Pin Functions

| PIN | | | | I/O | DESCRIPTION |
|------|-----|-----|--------|-----|--|
| NAME | DDC | YZY | DRV | | |
| IN | 1 | C3 | 6 | I | Input supply. |
| GND | 2 | B2 | 3, Pad | — | Ground. The pad must be tied to GND. |
| EN | 3 | A1 | 4 | I | Driving this pin high turns on the regulator. Driving this pin low puts the regulator into shutdown mode. EN can be connected to IN if not used. |
| NR | 4 | A3 | 2 | — | Fixed voltage versions only. Noise reduction; connecting this pin to an external capacitor bypasses noise generated by the internal band gap. This capacitor allows output noise to be reduced to very low levels. |
| FB | 4 | A3 | 2 | I | Adjustable voltage version only. Feedback; this pin is the input to the control loop error amplifier, and sets the output voltage of the device. |
| OUT | 5 | C1 | 1 | O | Output of the regulator. To assure stability, a small ceramic capacitor (total typical capacitance $\geq 2 \mu\text{F}$) is required from this pin to ground. |
| N/C | — | — | 5 | — | Not internally connected. This pin must either be left open, or tied to GND. |

6 Specifications

6.1 Absolute Maximum Ratings

over operating junction temperature range (unless otherwise noted) ⁽¹⁾

| | | MIN | MAX | UNIT |
|------------------------|---|--------------------|-----------------------|------|
| Voltage ⁽²⁾ | IN | –0.3 | 7.0 | V |
| | EN | –0.3 | V _{IN} + 0.3 | V |
| | OUT | –0.3 | V _{IN} + 0.3 | V |
| Current | OUT | Internally limited | | mA |
| Temperature | Operating virtual junction, T _J | –55 | 150 | °C |
| | Storage temperature range, T _{stg} | –55 | 150 | °C |

- (1) Stresses beyond those listed under *Absolute Maximum Ratings* may cause permanent damage to the device. These are stress ratings only, which do not imply functional operation of the device at these or any other conditions beyond those indicated under *Recommended Operating Conditions*. Exposure to absolute-maximum-rated conditions for extended periods may affect device reliability.
- (2) All voltages are with respect to network ground terminal.

6.2 ESD Ratings

| | | VALUE | UNIT |
|--------------------|-------------------------|--|-------|
| V _(ESD) | Electrostatic discharge | Human body model (HBM), per ANSI/ESDA/JEDEC JS-001, all pins ⁽¹⁾ | ±2000 |
| | | Charged device model (CDM), per JEDEC specification JESD22-C101, all pins ⁽²⁾ | ±500 |

- (1) JEDEC document JEP155 states that 500-V HBM allows safe manufacturing with a standard ESD control process.
- (2) JEDEC document JEP157 states that 250-V CDM allows safe manufacturing with a standard ESD control process.

6.3 Recommended Operating Conditions

over operating junction temperature range (unless otherwise noted)

| | | MIN | NOM | MAX | UNIT |
|------------------|--------------------------------|-----|-----|-----|------|
| V _{IN} | Input voltage | 2.7 | | 6.5 | V |
| I _{OUT} | Output current | 0.5 | | 200 | mA |
| T _J | Operating junction temperature | –40 | | 125 | °C |

6.4 Thermal Information

| THERMAL METRIC ⁽¹⁾ | | TPS799 | | | UNIT |
|-------------------------------|--|-----------|-----------|-------------|------|
| | | DDC (SOT) | DRV (SON) | YZU (DSBGA) | |
| | | 5 PINS | 6 PINS | 5 PINS | |
| R _{θJA} | Junction-to-ambient thermal resistance | 225.3 | 74.2 | 143.3 | °C/W |
| R _{θJC(top)} | Junction-to-case (top) thermal resistance | 39.3 | 58.8 | 1.1 | |
| R _{θJB} | Junction-to-board thermal resistance | 47.3 | 145.9 | 84.7 | |
| Ψ _{JT} | Junction-to-top characterization parameter | 0.5 | 0.2 | 3.8 | |
| Ψ _{JB} | Junction-to-board characterization parameter | 46.7 | 54.4 | 84.4 | |
| R _{θJC(bot)} | Junction-to-case (bottom) thermal resistance | N/A | 7.2 | N/A | |

- (1) For more information about traditional and new thermal metrics, see the *IC Package Thermal Metrics* application report, [SPRA953](#).

6.5 Electrical Characteristics

Over operating temperature range ($T_J = -40^\circ\text{C}$ to 125°C), $V_{IN} = V_{OUT(nom)} + 0.3\text{ V}$ or 2.7 V , whichever is greater; $I_{OUT} = 1\text{ mA}$, $V_{EN} = V_{IN}$, $C_{OUT} = 2.2\ \mu\text{F}$, $C_{NR} = 0.01\ \mu\text{F}$, unless otherwise noted. For TPS79901, $V_{OUT} = 3.0\text{ V}$. Typical values are at $T_J = 25^\circ\text{C}$.

| PARAMETER | | TEST CONDITIONS | MIN | TYP | MAX | UNIT |
|---------------------------|--|--|----------------------------------|-----------------------|----------|---------------------|
| V_{IN} | Input voltage range ⁽¹⁾ | | 2.7 | | 6.5 | V |
| V_{FB} | Internal reference (TPS79901) | | 1.169 | 1.193 | 1.217 | V |
| V_{OUT} | Output voltage range (TPS79901) | | V_{FB} | $6.5 - V_{DO}$ | | V |
| V_{OUT} | Output accuracy, nominal | $T_J = 25^\circ\text{C}$ | -1% | | 1% | |
| | Output accuracy ⁽¹⁾ Over V_{IN} , I_{OUT} , temperature | $V_{OUT} + 0.3\text{ V} \leq V_{IN} \leq 6.5\text{ V}$ $500\ \mu\text{A} \leq I_{OUT} \leq 200\text{ mA}$ | -2% | $\pm 1\%$ | 2% | |
| $\Delta V_{O(\Delta VI)}$ | Line regulation ⁽¹⁾ | $V_{OUT(NOM)} + 0.3\text{ V} \leq V_{IN} \leq 6.5\text{ V}$ | | 0.02 | | %/V |
| $\Delta V_{O(\Delta IO)}$ | Load regulation | $500\ \mu\text{A} \leq I_{OUT} \leq 200\text{ mA}$ | | 0.002 | | %/mA |
| V_{DO} | Dropout voltage ⁽²⁾ ($V_{IN} = V_{OUT(nom)} - 0.1\text{ V}$) | $I_{OUT} = 200\text{ mA}$ | $V_{OUT(nom)} \leq 3.3\text{ V}$ | 100 | 175 | mV |
| | | | $V_{OUT(nom)} \geq 3.3\text{ V}$ | 90 | 160 | mV |
| I_{CL} | Output current limit | $V_{OUT} = 0.9 \times V_{OUT(nom)}$ | 220 | 400 | 600 | mA |
| I_{GND} | Ground pin current | $500\ \mu\text{A} \leq I_{OUT} \leq 200\text{ mA}$ | | 40 | 60 | μA |
| I_{SHDN} | Shutdown current (I_{GND}) | $V_{EN} \leq 0.4\text{ V}$, $2.7\text{ V} \leq V_{IN} \leq 6.5\text{ V}$ | | 0.15 | 1 | μA |
| I_{FB} | Feedback pin current (TPS79901) | | -0.5 | | 0.5 | μA |
| PSRR | Power-supply rejection ratio | $V_{IN} = 3.85\text{ V}$, $V_{OUT} = 2.85\text{ V}$, $C_{NR} = 0.01\ \mu\text{F}$, $I_{OUT} = 100\text{ mA}$ | $f = 100\text{ Hz}$ | 70 | | dB |
| | | | $f = 1\text{ kHz}$ | 66 | | dB |
| | | | $f = 10\text{ kHz}$ | 51 | | dB |
| | | | $f = 100\text{ kHz}$ | 38 | | dB |
| V_n | Output noise voltage | BW = 10 Hz to 100 kHz, $V_{OUT} = 2.85\text{ V}$ | $C_{NR} = 0.01\ \mu\text{F}$ | $10.5 \times V_{OUT}$ | | μV_{RMS} |
| | | | $C_{NR} = \text{none}$ | $94 \times V_{OUT}$ | | μV_{RMS} |
| | Start-up time | $V_{OUT} = 2.85\text{ V}$, $R_L = 14\ \Omega$, $C_{OUT} = 2.2\ \mu\text{F}$ | $C_{NR} = 0.001\ \mu\text{F}$ | 45 | | μs |
| | | | $C_{NR} = 0.047\ \mu\text{F}$ | 45 | | μs |
| | | | $C_{NR} = 0.01\ \mu\text{F}$ | 50 | | μs |
| | | | $C_{NR} = \text{none}$ | 50 | | μs |
| $V_{EN(HI)}$ | Enable high (enabled) | | 1.2 | | V_{IN} | V |
| $V_{EN(LO)}$ | Enable low (shutdown) | | 0 | | 0.4 | V |
| $I_{EN(HI)}$ | Enable pin current, enabled | $V_{EN} = V_{IN} = 6.5\text{ V}$ | | 0.03 | 1 | μA |
| T_{sd} | Thermal shutdown temperature | Shutdown, temperature increasing | | 165 | | $^\circ\text{C}$ |
| | | Reset, temperature decreasing | | 145 | | $^\circ\text{C}$ |
| T_J | Operating junction temperature | | -40 | | 125 | $^\circ\text{C}$ |
| UVLO | Undervoltage lockout | V_{IN} rising | 1.90 | 2.20 | 2.65 | V |
| | Hysteresis | V_{IN} falling | | 70 | | mV |

(1) Minimum $V_{IN} = V_{OUT} + V_{DO}$ or 2.7 V , whichever is greater.

(2) V_{DO} is not measured for devices with $V_{OUT(nom)} < 2.8\text{ V}$ because minimum $V_{IN} = 2.7\text{ V}$.

6.6 Typical Characteristics

Over operating temperature range ($T_J = -40^\circ\text{C}$ to 125°C), $V_{IN} = V_{OUT(nom)} + 0.3\text{ V}$ or 2.7 V , whichever is greater; $I_{OUT} = 1\text{ mA}$, $V_{EN} = V_{IN}$, $C_{OUT} = 2.2\ \mu\text{F}$, and $C_{NR} = 0.01\ \mu\text{F}$, unless otherwise noted. For TPS79901, $V_{OUT} = 3.0\text{ V}$. Typical values are at $T_J = 25^\circ\text{C}$.

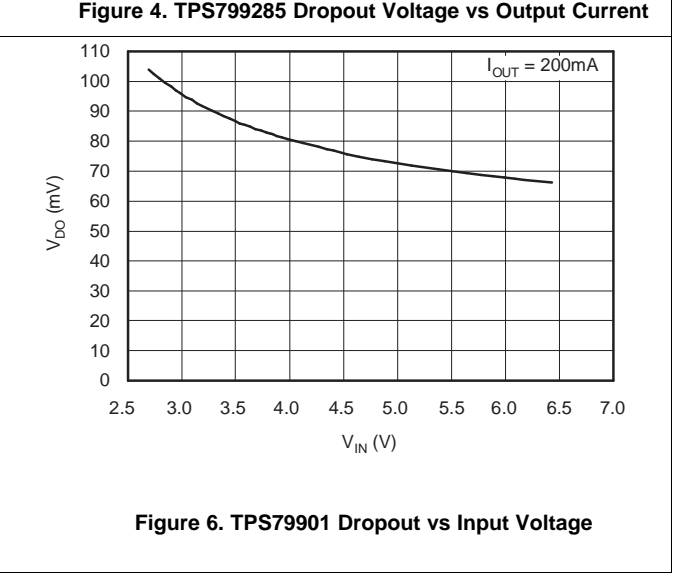
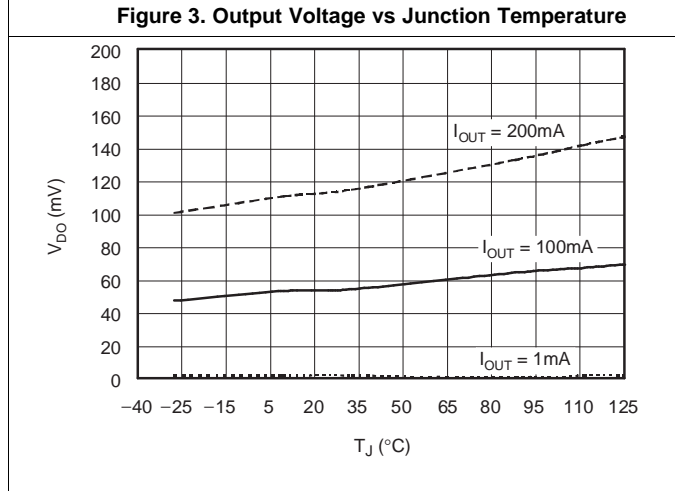
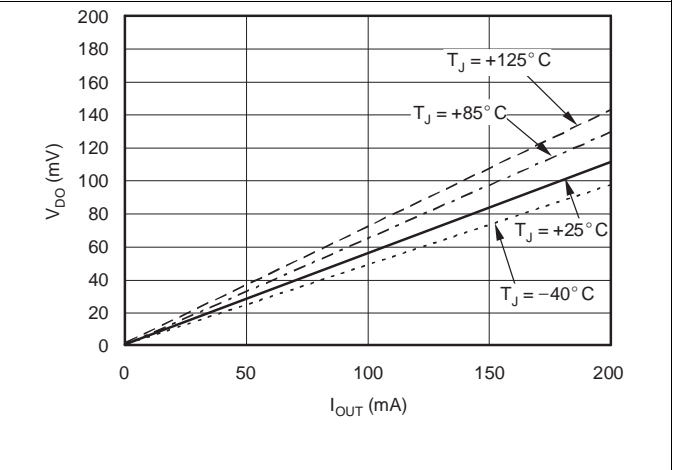
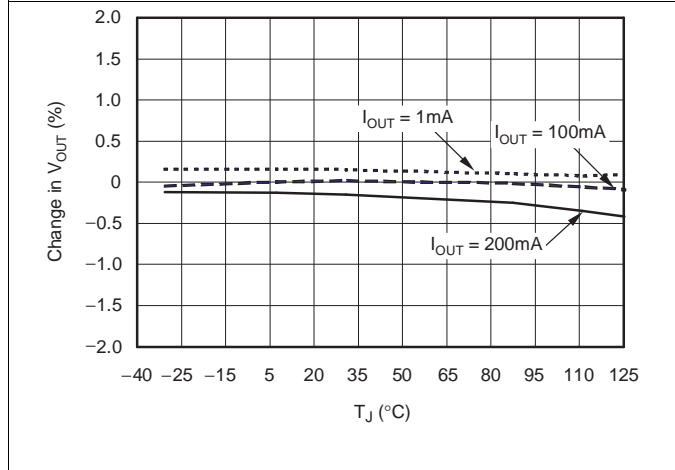
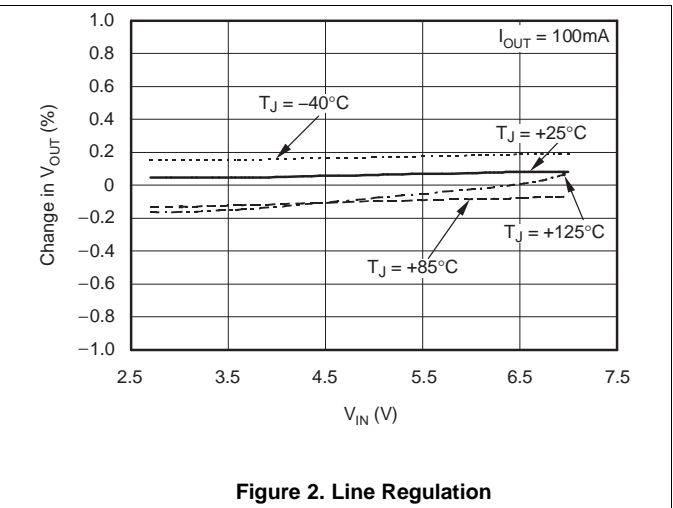
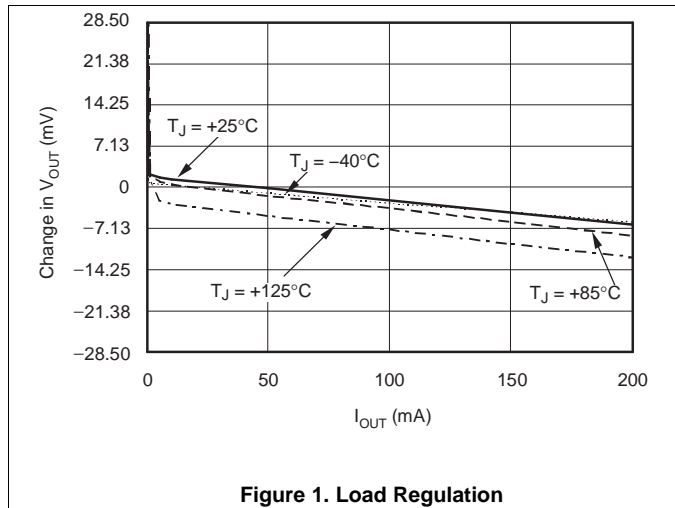

Typical Characteristics (continued)

Over operating temperature range ($T_J = -40^\circ\text{C}$ to 125°C), $V_{IN} = V_{OUT(nom)} + 0.3\text{ V}$ or 2.7 V , whichever is greater; $I_{OUT} = 1\text{ mA}$, $V_{EN} = V_{IN}$, $C_{OUT} = 2.2\ \mu\text{F}$, and $C_{NR} = 0.01\ \mu\text{F}$, unless otherwise noted. For TPS79901, $V_{OUT} = 3.0\text{ V}$. Typical values are at $T_J = 25^\circ\text{C}$.

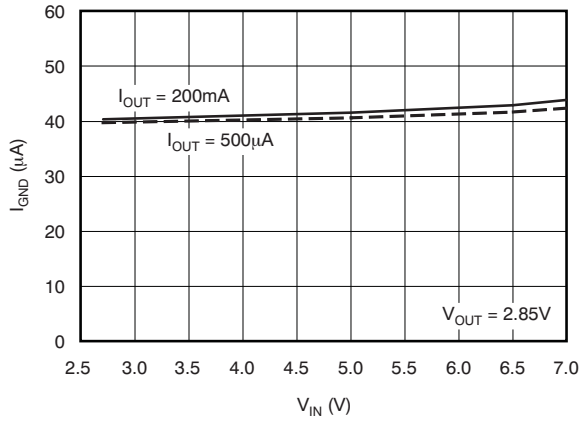

Figure 7. Ground Pin Current vs Input Voltage

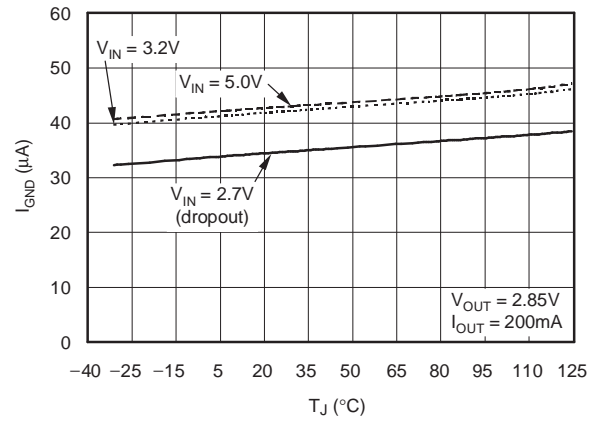

Figure 8. TPS799285 Ground Pin Current vs Junction Temperature

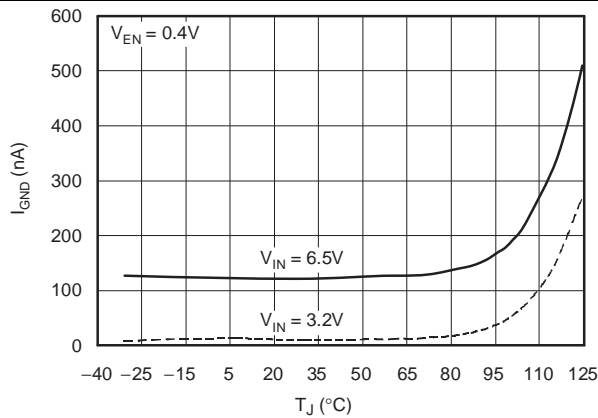

Figure 9. Ground Pin Current (Disabled) vs Junction Temperature

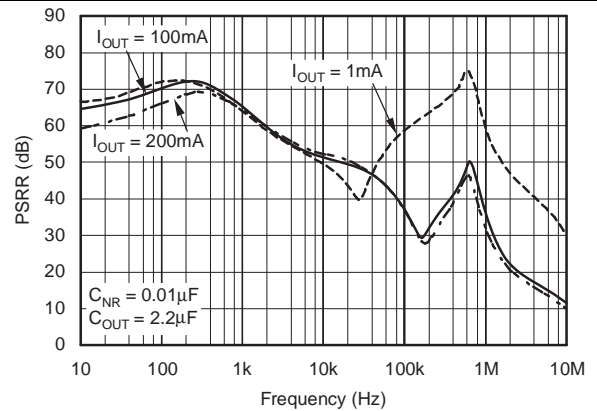

Figure 10. TPS799285 Power-Supply Ripple Rejection vs Frequency ($V_{IN} - V_{OUT} = 1.0\text{ V}$)

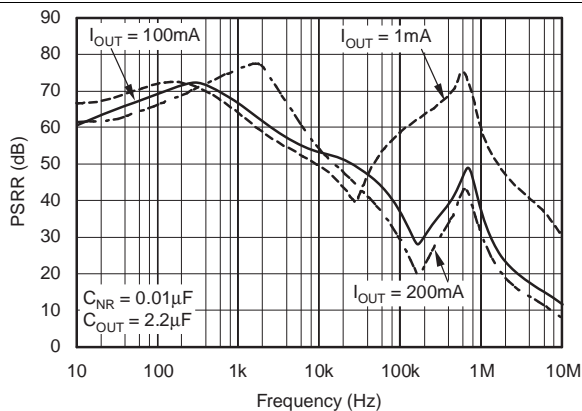

Figure 11. TPS799285 Power-Supply Ripple Rejection vs Frequency ($V_{IN} - V_{OUT} = 0.5\text{ V}$)

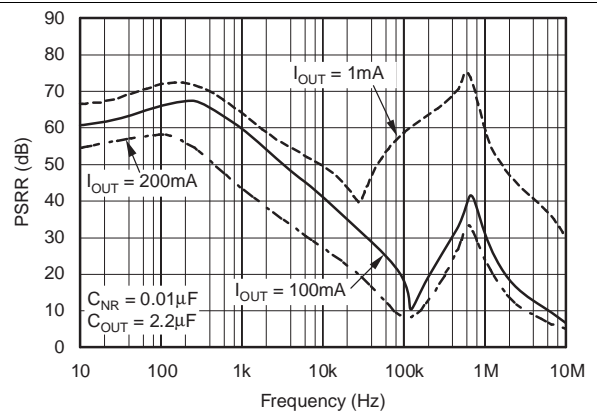

Figure 12. TPS799285 Power-Supply Ripple Rejection vs Frequency ($V_{IN} - V_{OUT} = 0.25\text{ V}$)

Typical Characteristics (continued)

Over operating temperature range ($T_J = -40^\circ\text{C}$ to 125°C), $V_{IN} = V_{OUT(nom)} + 0.3\text{ V}$ or 2.7 V , whichever is greater; $I_{OUT} = 1\text{ mA}$, $V_{EN} = V_{IN}$, $C_{OUT} = 2.2\ \mu\text{F}$, and $C_{NR} = 0.01\ \mu\text{F}$, unless otherwise noted. For TPS79901, $V_{OUT} = 3.0\text{ V}$. Typical values are at $T_J = 25^\circ\text{C}$.

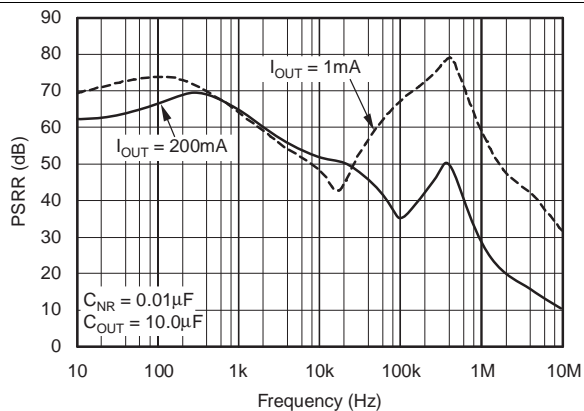

Figure 13. TPS799285 Power-Supply Ripple Rejection vs Frequency ($V_{IN} - V_{OUT} = 1.0\text{ V}$)

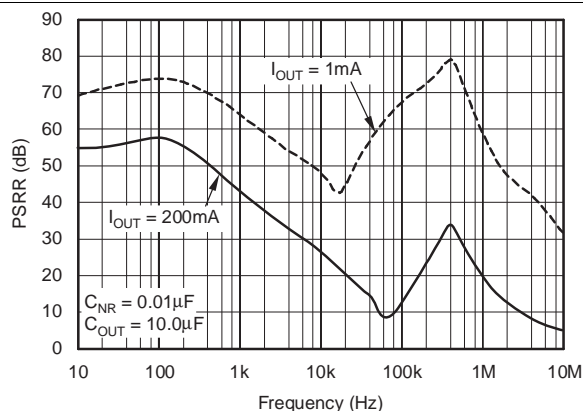

Figure 14. TPS799285 Power-Supply Ripple Rejection vs Frequency ($V_{IN} - V_{OUT} = 0.25\text{ V}$)

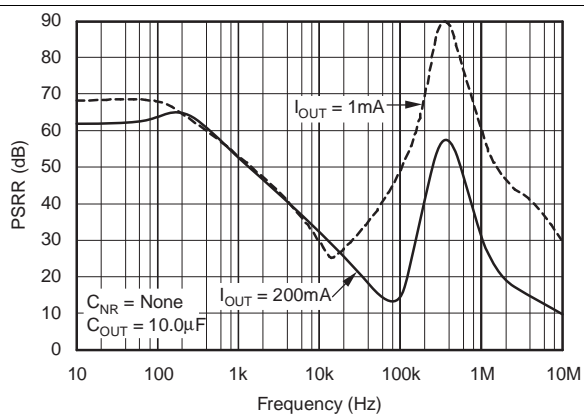

Figure 15. TPS799285 Power-Supply Ripple Rejection vs Frequency ($V_{IN} - V_{OUT} = 1.0\text{ V}$)

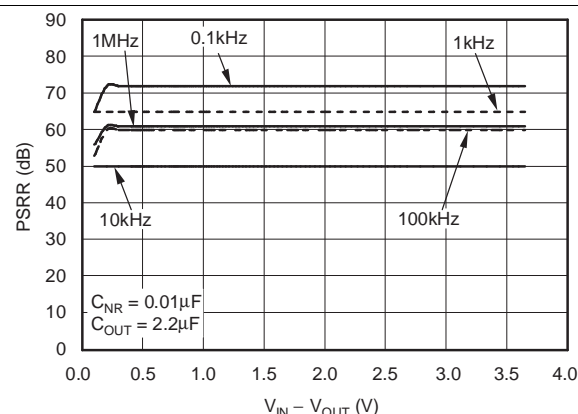

Figure 16. Power-Supply Ripple Rejection vs $V_{IN} - V_{OUT}$, $I_{OUT} = 1\text{ mA}$

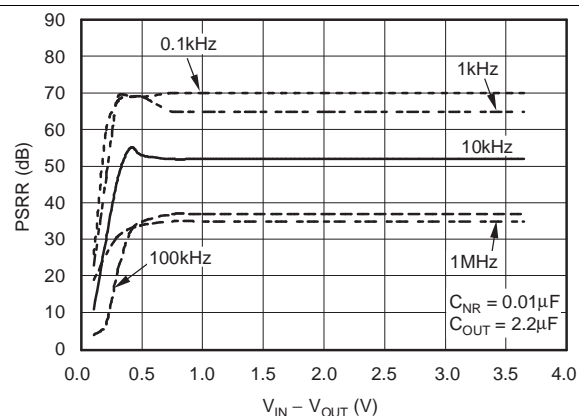

Figure 17. Power-Supply Ripple Rejection vs $V_{IN} - V_{OUT}$, $I_{OUT} = 100\text{ mA}$

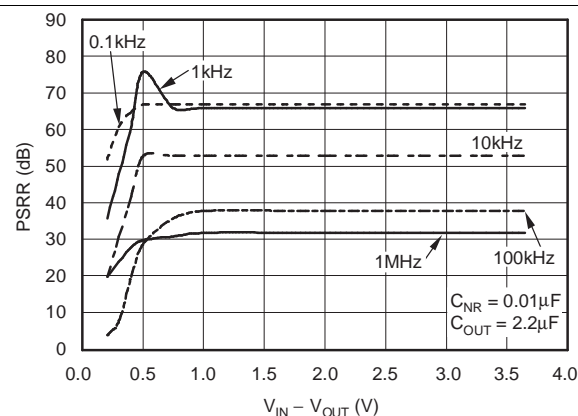

Figure 18. Power-Supply Ripple Rejection vs $V_{IN} - V_{OUT}$, $I_{OUT} = 200\text{ mA}$

Typical Characteristics (continued)

Over operating temperature range ($T_J = -40^\circ\text{C}$ to 125°C), $V_{IN} = V_{OUT(nom)} + 0.3\text{ V}$ or 2.7 V , whichever is greater; $I_{OUT} = 1\text{ mA}$, $V_{EN} = V_{IN}$, $C_{OUT} = 2.2\ \mu\text{F}$, and $C_{NR} = 0.01\ \mu\text{F}$, unless otherwise noted. For TPS79901, $V_{OUT} = 3.0\text{ V}$. Typical values are at $T_J = 25^\circ\text{C}$.

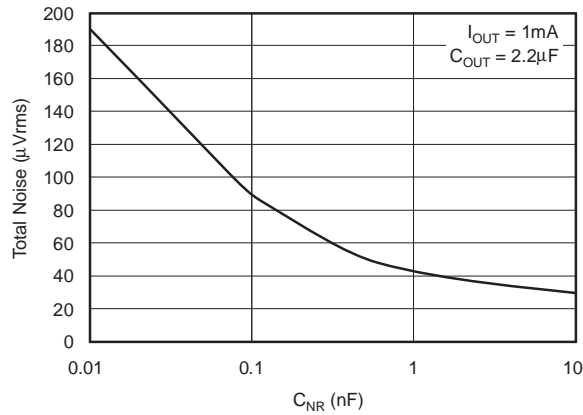

Figure 19. TPS799285 Total Noise vs C_{NR}

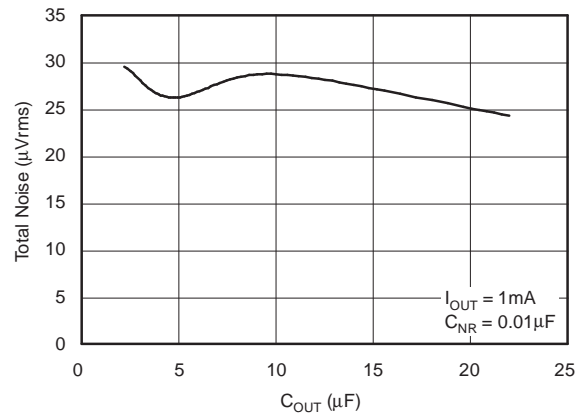

Figure 20. TPS799285 Total Noise vs C_{OUT}

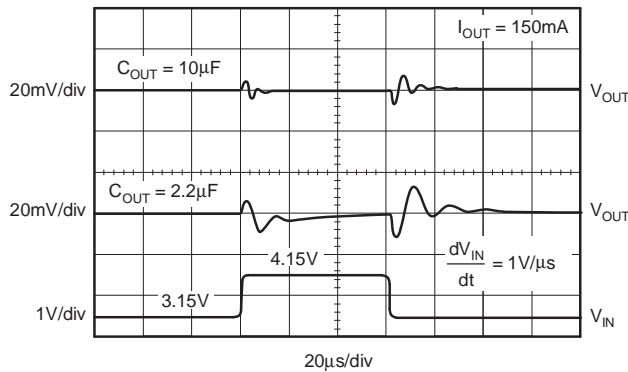

Figure 21. TPS799285 Line Transient Response

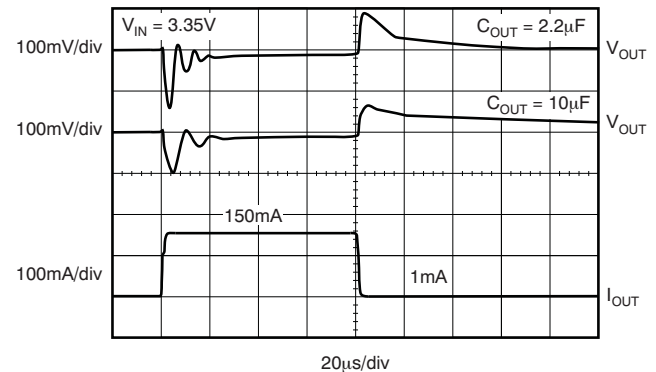

Figure 22. TPS799285 Load Transient Response

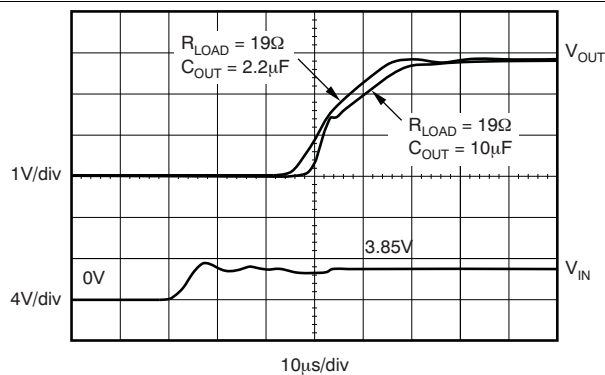

Figure 23. TPS799285 Turn-On Response ($V_{EN} = V_{IN}$)

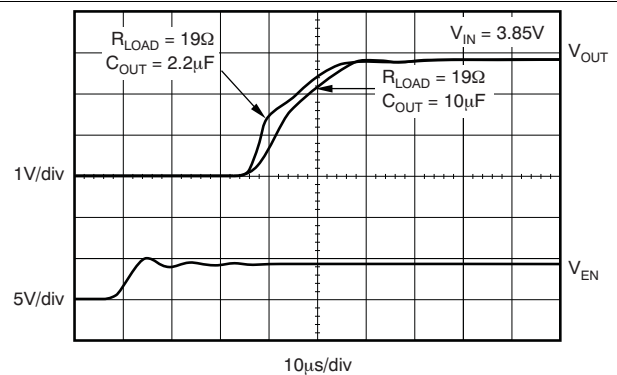

Figure 24. TPS799285 Enable Response

Typical Characteristics (continued)

Over operating temperature range ($T_J = -40^{\circ}\text{C}$ to 125°C), $V_{IN} = V_{OUT(nom)} + 0.3\text{ V}$ or 2.7 V , whichever is greater; $I_{OUT} = 1\text{ mA}$, $V_{EN} = V_{IN}$, $C_{OUT} = 2.2\text{ }\mu\text{F}$, and $C_{NR} = 0.01\text{ }\mu\text{F}$, unless otherwise noted. For TPS79901, $V_{OUT} = 3.0\text{ V}$. Typical values are at $T_J = 25^{\circ}\text{C}$.

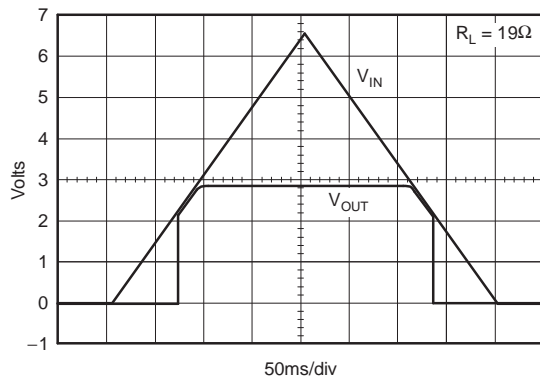

Figure 25. TPS799285 Power-Up/Power-Down

7 Detailed Description

7.1 Overview

The TPS799 family of low-dropout (LDO) regulators combines the high performance required of many RF and precision analog applications with ultralow current consumption. High PSRR is provided by a high-gain, high-bandwidth error loop with good supply rejection at very low headroom ($V_{IN} - V_{OUT}$). A noise-reduction pin is provided to bypass noise generated by the band-gap reference and to improve PSRR, while a quick-start circuit quickly charges this capacitor at start-up. The combination of high performance and low ground current also make these devices an excellent choice for portable applications. All versions have thermal and overcurrent protection, and are fully specified from -40°C to 125°C .

The TPS799 family also features inrush current protection with an EN toggle start-up, and overshoot detection at the output. When the EN toggle is used to start the device, current limit protection is immediately activated, restricting the inrush current to the device. If voltage at the output overshoots 5% from the nominal value, a pulldown resistor reduces the voltage to normal operating conditions, as shown in the [Functional Block Diagram](#).

7.2 Functional Block Diagram

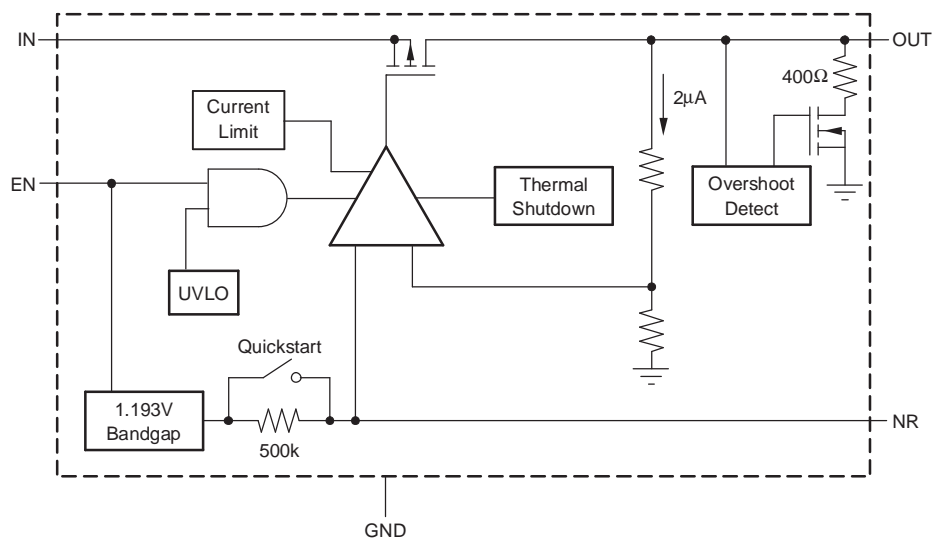

Figure 26. Fixed-Voltage Versions

Functional Block Diagram (continued)

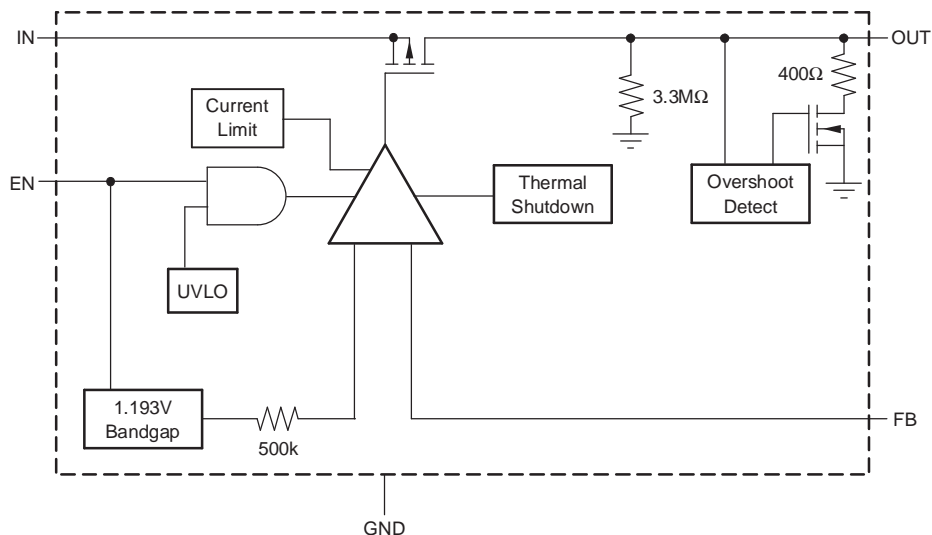

Figure 27. Adjustable-Voltage Versions

7.3 Feature Description

7.3.1 Internal Current Limit

The TPS799 internal current limit helps protect the regulator during fault conditions. In current limit mode, the output sources a fixed amount of current that is largely independent of the output voltage. For reliable operation, do not operate the device in a current-limit state for extended periods of time.

The PMOS pass element in the TPS799 has a built-in body diode that conducts current when the voltage at OUT exceeds the voltage at IN. This current is not limited; therefore, if extended reverse voltage operation is anticipated, external limiting may be required.

7.3.2 Shutdown

The enable pin (EN) is active high and is compatible with standard and low-voltage TTL-CMOS levels. When shutdown capability is not required, EN can be connected to IN.

7.3.3 Start Up

The TPS799 uses a start-up circuit to quickly charge the noise reduction capacitor, C_{NR} , if present (see the [Functional Block Diagram](#)). This circuit allows for the combination of very low output noise and fast start-up times. The NR pin is high impedance so a low leakage C_{NR} capacitor must be used; most ceramic capacitors are appropriate for this configuration.

Note that for fastest start-up, apply V_{IN} first, and then drive the enable pin (EN) high. If EN is tied to IN, start-up is somewhat slower. The start-up switch is closed for approximately 135 μ s. To ensure that C_{NR} is fully charged during start-up, use a 0.01- μ F or smaller capacitor.

7.3.4 Undervoltage Lockout (UVLO)

The TPS799 uses an undervoltage lockout circuit to keep the output shut off until internal circuitry is operating properly. The UVLO circuit has a deglitch feature so that undershoot transients are typically ignored on the input if these transients are less than 50 μ s in duration.

7.4 Device Functional Modes

Driving EN over 1.2 V turns on the regulator. Driving EN below 0.4 V puts the regulator into shutdown mode, thus reducing the operating current to 150 nA, nominal.

8 Application and Implementation

NOTE

Information in the following applications sections is not part of the TI component specification, and TI does not warrant its accuracy or completeness. TI's customers are responsible for determining suitability of components for their purposes. Customers should validate and test their design implementation to confirm system functionality.

8.1 Application Information

The TPS799 family of LDO regulators provides high PSRR while maintaining ultralow current consumption. The family also features inrush current protection and overshoot detection at the output.

8.2 Typical Applications

Figure 28 and Figure 29 show the basic circuit connections.

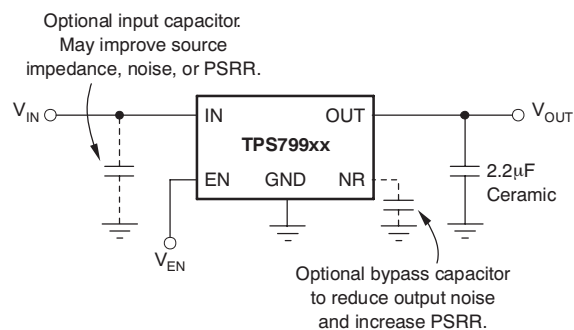

Figure 28. Typical Application Circuit for Fixed Voltage Versions

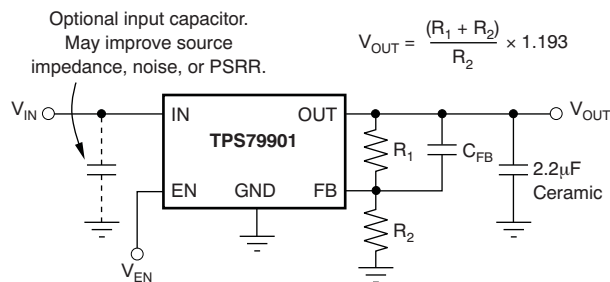

Figure 29. Typical Application Circuit for Adjustable Voltage Version

8.2.1 Design Requirements

Select the desired device based on the output voltage.

Provide an input supply with adequate headroom to account for dropout and output current to account for the GND terminal current, and power the load.

8.2.2 Detailed Design Procedure

8.2.2.1 Input and Output Capacitor Requirements

Although an input capacitor is not required for stability, good analog design practice is to connect a 0.1-µF to 1-µF low ESR capacitor across the input supply near the regulator. This capacitor counteracts reactive input sources and improves transient response, noise rejection, and ripple rejection. A higher-value capacitor may be necessary if large, fast rise-time load transients are anticipated, or if the device is located several inches from the power source. If source impedance is not sufficiently low, a 0.1-µF input capacitor may be necessary to ensure stability.

Typical Applications (continued)

The TPS799 is designed to be stable with standard ceramic capacitors with values of 2.2 μF or greater. X5R- and X7R-type capacitors are best because they have minimal variation in value and ESR over temperature. Maximum ESR must be less than 1.0 Ω .

8.2.2.2 Output Noise

In most LDOs, the band gap is the dominant noise source. If a noise-reduction capacitor (C_{NR}) is used with the TPS799, the band gap does not contribute significantly to noise. Instead, noise is dominated by the output resistor divider and the error amplifier input. To minimize noise in a given application, use a 0.01- μF noise reduction capacitor. To further optimize noise, equivalent series resistance of the output capacitor can be set to approximately 0.2 Ω . This configuration maximizes phase margin in the control loop, reducing total output noise by up to 10%.

Noise can be referred to the feedback point; with $C_{\text{NR}} = 0.01 \mu\text{F}$ total noise is approximately given by [Equation 1](#):

$$V_N = \frac{10.5 \mu\text{V}_{\text{RMS}}}{V} \times V_{\text{OUT}} \quad (1)$$

8.2.2.3 Dropout Voltage

The TPS799 uses a PMOS pass transistor to achieve a low dropout voltage. When $(V_{\text{IN}} - V_{\text{OUT}})$ is less than the dropout voltage (V_{DO}), the PMOS pass device is in its linear region of operation and $r_{\text{DS(on)}}$ of the PMOS pass element is the input-to-output resistance. Because the PMOS device behaves like a resistor in dropout, V_{DO} approximately scales with the output current.

As with any linear regulator, PSRR degrades as $(V_{\text{IN}} - V_{\text{OUT}})$ approaches dropout. This effect is illustrated in [Figure 10](#) through [Figure 18](#) in the [Typical Characteristics](#) section.

8.2.2.4 Transient Response

As with any regulator, increasing the size of the output capacitor reduces over- and undershoot magnitude, but increases the duration of the transient response. The transient response of the TPS799 is enhanced by an active pulldown device that engages when the output overshoots by approximately 5% or more when the device is enabled. When enabled, the pulldown device behaves like a 350- Ω resistor to ground.

8.2.2.5 Minimum Load

The TPS799 is stable with no output load. To meet the specified accuracy, a minimum load of 500 μA is required. With loads less than 500 μA at junction temperatures near 125°C, the output can drift up enough to cause the output pulldown device to turn on. The output pulldown device limits voltage drift to 5% typically; however, ground current can increase by approximately 50 μA . In typical applications, the junction cannot reach high temperatures at light loads because there is no noticeable dissipated power. The specified ground current is then valid at no load in most applications.

8.2.2.6 Feedback Capacitor Requirements (TPS79901 Only)

The feedback capacitor, C_{FB} , shown in [Figure 29](#) is required for stability. For a parallel combination of R_1 and R_2 equal to 250 k Ω , any value from 3 pF to 1 nF can be used. Fixed voltage versions have an internal 30-pF feedback capacitor which is quick-charged at start-up. The adjustable version does not have this quick-charge circuit, so values below 5 pF should be used to ensure fast startup; values above 47 pF can be used to implement an output voltage soft-start. Larger value capacitors also improve noise slightly. The TPS79901 is stable in unity-gain configuration (OUT tied to FB) without C_{FB} .

Typical Applications (continued)

8.2.3 Application Curve

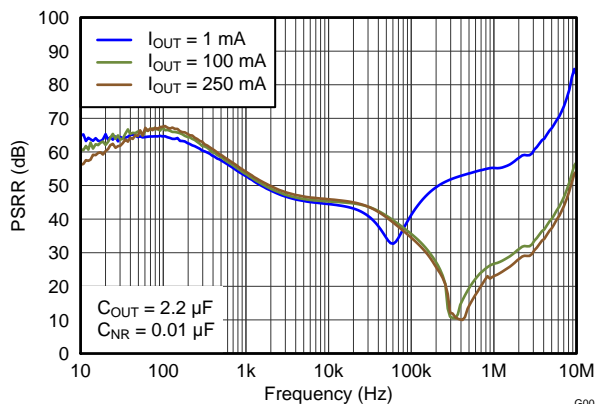

Figure 30. Power-Supply Rejection Ratio vs Frequency

8.3 Do's and Don'ts

Do place at least one 2.2- μ F ceramic capacitor as close as possible to the OUT pin of the regulator.

Do not place the output capacitor more than 10 mm away from the regulator.

Do connect a 0.1- μ F to 1- μ F low equivalent series resistance (ESR) capacitor across the IN pin and GND input of the regulator.

Do not exceed the absolute maximum ratings.

9 Power Supply Recommendations

These devices are designed to operate from an input voltage supply range between 2.7 V and 6.5 V. The input voltage range provides adequate headroom in order for the device to have a regulated output. This input supply is well-regulated and stable. If the input supply is noisy, additional input capacitors with low ESR can help improve the output noise performance.

10 Layout

10.1 Layout Guidelines

10.1.1 Board Layout Recommendations to Improve PSRR and Noise Performance

To improve ac performance (such as PSRR, output noise, and transient response), design the board with separate ground planes for V_{IN} and V_{OUT} , with each ground plane connected only at the GND pin of the device. In addition, connect the bypass capacitor directly to the GND pin of the device.

10.2 Layout Example

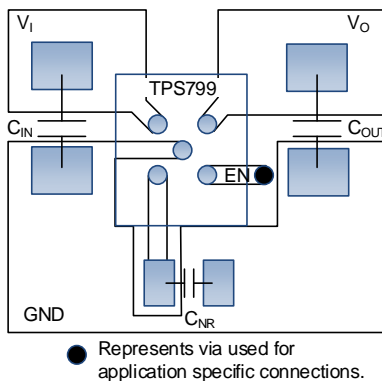

Figure 31. Layout Example

10.3 Thermal Information

10.3.1 Thermal Protection

Thermal protection disables the output when the junction temperature rises to approximately 165°C, allowing the device to cool. When the junction temperature cools to approximately 145°C the output circuitry is again enabled. Depending on power dissipation, thermal resistance, and ambient temperature, the thermal protection circuit may cycle on and off. This cycling limits the dissipation of the regulator, protecting it from damage resulting from overheating.

Any tendency to activate the thermal protection circuit indicates excessive power dissipation or an inadequate heatsink. For reliable operation, limit junction temperature to 125°C maximum. To estimate the margin of safety in a complete design (including heatsink), increase the ambient temperature until the thermal protection is triggered; use worst-case loads and signal conditions. For good reliability, thermal protection triggers at least 35°C above the maximum expected ambient condition of a particular application. This configuration produces a worst-case junction temperature of 125°C at the highest expected ambient temperature and worst-case load.

The internal protection circuitry of the TPS799 is designed to protect against overload conditions. This circuitry is not intended to replace proper heatsinking. Continuously running the device into thermal shutdown degrades device reliability.

10.3.2 Power Dissipation

The ability to remove heat from the die is different for each package type, presenting different considerations in the PCB layout. The PCB area around the device that is free of other components moves the heat from the device to the ambient air. Performance data for JEDEC low- and high-K boards are given in the [Thermal Information](#) table near the front of this data sheet. Using heavier copper increases the effectiveness in removing heat from the device. The addition of plated through-holes to heat-dissipating layers also improves heatsink effectiveness.

Power dissipation depends on input voltage and load conditions. Power dissipation is equal to the product of the output current times the voltage drop across the output pass element, as shown in [Equation 2](#):

$$P_D = (V_{IN} - V_{OUT}) \cdot I_{OUT} \quad (2)$$

10.3.3 Package Mounting

Solder pad footprint recommendations for the TPS799 are available from the TI's website at www.ti.com.

11 Device and Documentation Support

11.1 Device Support

11.1.1 Development Support

11.1.1.1 Evaluation Modules

An evaluation module (EVM) is available to assist in the initial circuit performance evaluation using the TPS799. This EVM, the TPS799 evaluation module, can be requested at the Texas Instruments web site through the product folders or purchased [directly from the TI eStore](#).

11.1.1.2 Spice Models

Computer simulation of circuit performance using SPICE is often useful when analyzing the performance of analog circuits and systems. A SPICE model for the TPS799 is available through the product folders under simulation models.

11.1.2 Device Nomenclature

Table 1. Device Nomenclature⁽¹⁾

| PRODUCT | V _{OUT} |
|-------------------|---|
| TPS799xx(x) yyy z | xx(x) is nominal output voltage (for example, 28 = 2.8 V, 285 = 2.85 V, 01 = Adjustable). yyy is package designator. z is package quantity. |

(1) For the most current package and ordering information see the Package Option Addendum at the end of this document, or visit the device product folder at www.ti.com.

11.2 Documentation Support

11.2.1 Related Documentation

For related documentation, see the following:

- Application report: *Using New Thermal Metrics*, [SBVA025](#).
- Application report: *IC Package Thermal Metrics*, [SPRA953](#)
- *TPS799xxEVM-105 User's Guide*, [SLVU130](#)

11.3 Trademarks

Bluetooth is a registered trademark of Bluetooth SIG, Inc.

All other trademarks are the property of their respective owners.

11.4 Electrostatic Discharge Caution



This integrated circuit can be damaged by ESD. Texas Instruments recommends that all integrated circuits be handled with appropriate precautions. Failure to observe proper handling and installation procedures can cause damage.

ESD damage can range from subtle performance degradation to complete device failure. Precision integrated circuits may be more susceptible to damage because very small parametric changes could cause the device not to meet its published specifications.

11.5 Glossary

[SLYZ022](#) — *TI Glossary*.

This glossary lists and explains terms, acronyms, and definitions.

12 Mechanical, Packaging, and Orderable Information

The following pages include mechanical, packaging, and orderable information. This information is the most current data available for the designated devices. This data is subject to change without notice and revision of this document. For browser-based versions of this data sheet, refer to the left-hand navigation.

PACKAGING INFORMATION

| Orderable Device | Status (1) | Package Type | Package Drawing | Pins | Package Qty | Eco Plan (2) | Lead/Ball Finish (6) | MSL Peak Temp (3) | Op Temp (°C) | Device Marking (4/5) | Samples |
|------------------|---------------|--------------|-----------------|------|-------------|-------------------------|-------------------------|----------------------|--------------|-------------------------|-------------------------|
| TPS79901DDCR | ACTIVE | SOT-23-THIN | DDC | 5 | 3000 | Green (RoHS & no Sb/Br) | NIPDAU | Level-1-260C-UNLIM | -40 to 125 | AWT | Samples |
| TPS79901DDCRG4 | ACTIVE | SOT-23-THIN | DDC | 5 | 3000 | Green (RoHS & no Sb/Br) | NIPDAU | Level-1-260C-UNLIM | -40 to 125 | AWT | Samples |
| TPS79901DDCT | ACTIVE | SOT-23-THIN | DDC | 5 | 250 | Green (RoHS & no Sb/Br) | NIPDAU | Level-1-260C-UNLIM | -40 to 125 | AWT | Samples |
| TPS79901DDCTG4 | ACTIVE | SOT-23-THIN | DDC | 5 | 250 | Green (RoHS & no Sb/Br) | NIPDAU | Level-1-260C-UNLIM | -40 to 125 | AWT | Samples |
| TPS79901DRVR | ACTIVE | WSON | DRV | 6 | 3000 | Green (RoHS & no Sb/Br) | NIPDAU | Level-1-260C-UNLIM | -40 to 125 | AWT | Samples |
| TPS79901DRVRG4 | ACTIVE | WSON | DRV | 6 | 3000 | Green (RoHS & no Sb/Br) | NIPDAU | Level-1-260C-UNLIM | -40 to 125 | AWT | Samples |
| TPS79901DRVT | ACTIVE | WSON | DRV | 6 | 250 | Green (RoHS & no Sb/Br) | NIPDAU | Level-1-260C-UNLIM | -40 to 125 | AWT | Samples |
| TPS79901YZUR | ACTIVE | DSBGA | YZU | 5 | 3000 | Green (RoHS & no Sb/Br) | SNAGCU | Level-1-260C-UNLIM | -40 to 125 | E9 | Samples |
| TPS79901YZUT | ACTIVE | DSBGA | YZU | 5 | 250 | Green (RoHS & no Sb/Br) | SNAGCU | Level-1-260C-UNLIM | -40 to 125 | E9 | Samples |
| TPS799125YZUR | ACTIVE | DSBGA | YZU | 5 | 3000 | Green (RoHS & no Sb/Br) | SNAGCU | Level-1-260C-UNLIM | -40 to 125 | YZ | Samples |
| TPS799125YZUT | ACTIVE | DSBGA | YZU | 5 | 250 | Green (RoHS & no Sb/Br) | SNAGCU | Level-1-260C-UNLIM | -40 to 125 | YZ | Samples |
| TPS79912DDCR | ACTIVE | SOT-23-THIN | DDC | 5 | 3000 | Green (RoHS & no Sb/Br) | NIPDAU | Level-1-260C-UNLIM | -40 to 125 | CCF | Samples |
| TPS79912DDCT | ACTIVE | SOT-23-THIN | DDC | 5 | 250 | Green (RoHS & no Sb/Br) | NIPDAU | Level-1-260C-UNLIM | -40 to 125 | CCF | Samples |
| TPS79912DRVR | ACTIVE | WSON | DRV | 6 | 3000 | Green (RoHS & no Sb/Br) | NIPDAU | Level-1-260C-UNLIM | -40 to 125 | CCF | Samples |
| TPS79912DRVT | ACTIVE | WSON | DRV | 6 | 250 | Green (RoHS & no Sb/Br) | NIPDAU | Level-1-260C-UNLIM | -40 to 125 | CCF | Samples |
| TPS79912DRVTG4 | ACTIVE | WSON | DRV | 6 | 250 | Green (RoHS & no Sb/Br) | NIPDAU | Level-1-260C-UNLIM | -40 to 125 | CCF | Samples |
| TPS79912YZUR | ACTIVE | DSBGA | YZU | 5 | 3000 | Green (RoHS & no Sb/Br) | SNAGCU | Level-1-260C-UNLIM | -40 to 125 | F8 | Samples |

| Orderable Device | Status (1) | Package Type | Package Drawing | Pins | Package Qty | Eco Plan (2) | Lead/Ball Finish (6) | MSL Peak Temp (3) | Op Temp (°C) | Device Marking (4/5) | Samples |
|------------------|---------------|--------------|-----------------|------|-------------|-------------------------|-------------------------|----------------------|--------------|-------------------------|-------------------------|
| TPS79912YZUT | ACTIVE | DSBGA | YZU | 5 | 250 | Green (RoHS & no Sb/Br) | SNAGCU | Level-1-260C-UNLIM | -40 to 125 | F8 | Samples |
| TPS79913DDCR | ACTIVE | SOT-23-THIN | DDC | 5 | 3000 | Green (RoHS & no Sb/Br) | NIPDAU | Level-1-260C-UNLIM | -40 to 125 | BUJ | Samples |
| TPS79913DDCT | ACTIVE | SOT-23-THIN | DDC | 5 | 250 | Green (RoHS & no Sb/Br) | NIPDAU | Level-1-260C-UNLIM | -40 to 125 | BUJ | Samples |
| TPS79913DDCTG4 | ACTIVE | SOT-23-THIN | DDC | 5 | 250 | Green (RoHS & no Sb/Br) | NIPDAU | Level-1-260C-UNLIM | -40 to 125 | BUJ | Samples |
| TPS79913YZUR | ACTIVE | DSBGA | YZU | 5 | 3000 | Green (RoHS & no Sb/Br) | SNAGCU | Level-1-260C-UNLIM | -40 to 125 | F9 | Samples |
| TPS79915DDCR | ACTIVE | SOT-23-THIN | DDC | 5 | 3000 | Green (RoHS & no Sb/Br) | NIPDAU | Level-1-260C-UNLIM | -40 to 125 | AWU | Samples |
| TPS79915DDCT | ACTIVE | SOT-23-THIN | DDC | 5 | 250 | Green (RoHS & no Sb/Br) | NIPDAU | Level-1-260C-UNLIM | -40 to 125 | AWU | Samples |
| TPS79915DDCTG4 | ACTIVE | SOT-23-THIN | DDC | 5 | 250 | Green (RoHS & no Sb/Br) | NIPDAU | Level-1-260C-UNLIM | -40 to 125 | AWU | Samples |
| TPS79915YZUR | ACTIVE | DSBGA | YZU | 5 | 3000 | Green (RoHS & no Sb/Br) | SNAGCU | Level-1-260C-UNLIM | -40 to 125 | EA | Samples |
| TPS79915YZUT | ACTIVE | DSBGA | YZU | 5 | 250 | Green (RoHS & no Sb/Br) | SNAGCU | Level-1-260C-UNLIM | -40 to 125 | EA | Samples |
| TPS799185DDCR | ACTIVE | SOT-23-THIN | DDC | 5 | 3000 | Green (RoHS & no Sb/Br) | NIPDAU | Level-1-260C-UNLIM | -40 to 125 | CGP | Samples |
| TPS799185DDCRG4 | ACTIVE | SOT-23-THIN | DDC | 5 | 3000 | Green (RoHS & no Sb/Br) | NIPDAU | Level-1-260C-UNLIM | -40 to 125 | CGP | Samples |
| TPS799185DDCT | ACTIVE | SOT-23-THIN | DDC | 5 | 250 | Green (RoHS & no Sb/Br) | NIPDAU | Level-1-260C-UNLIM | -40 to 125 | CGP | Samples |
| TPS799185YZUR | ACTIVE | DSBGA | YZU | 5 | 3000 | Green (RoHS & no Sb/Br) | SNAGCU | Level-1-260C-UNLIM | -40 to 125 | ZA | Samples |
| TPS799185YZUT | ACTIVE | DSBGA | YZU | 5 | 250 | Green (RoHS & no Sb/Br) | SNAGCU | Level-1-260C-UNLIM | -40 to 125 | ZA | Samples |
| TPS79918DDCR | ACTIVE | SOT-23-THIN | DDC | 5 | 3000 | Green (RoHS & no Sb/Br) | NIPDAU | Level-1-260C-UNLIM | -40 to 125 | AWV | Samples |
| TPS79918DDCRG4 | ACTIVE | SOT-23-THIN | DDC | 5 | 3000 | Green (RoHS & no Sb/Br) | NIPDAU | Level-1-260C-UNLIM | -40 to 125 | AWV | Samples |
| TPS79918DDCT | ACTIVE | SOT-23-THIN | DDC | 5 | 250 | Green (RoHS & no Sb/Br) | NIPDAU | Level-1-260C-UNLIM | -40 to 125 | AWV | Samples |

| Orderable Device | Status (1) | Package Type | Package Drawing | Pins | Package Qty | Eco Plan (2) | Lead/Ball Finish (6) | MSL Peak Temp (3) | Op Temp (°C) | Device Marking (4/5) | Samples |
|------------------|---------------|--------------|-----------------|------|-------------|-------------------------|-------------------------|----------------------|--------------|-------------------------|-------------------------|
| TPS79918DDCTG4 | ACTIVE | SOT-23-THIN | DDC | 5 | 250 | Green (RoHS & no Sb/Br) | NIPDAU | Level-1-260C-UNLIM | -40 to 125 | AWV | Samples |
| TPS79918DRVR | ACTIVE | WSON | DRV | 6 | 3000 | Green (RoHS & no Sb/Br) | NIPDAU | Level-1-260C-UNLIM | -40 to 125 | AWV | Samples |
| TPS79918DRVRG4 | ACTIVE | WSON | DRV | 6 | 3000 | Green (RoHS & no Sb/Br) | NIPDAU | Level-1-260C-UNLIM | -40 to 125 | AWV | Samples |
| TPS79918DRVT | ACTIVE | WSON | DRV | 6 | 250 | Green (RoHS & no Sb/Br) | NIPDAU | Level-1-260C-UNLIM | -40 to 125 | AWV | Samples |
| TPS79918YZUR | ACTIVE | DSBGA | YZU | 5 | 3000 | Green (RoHS & no Sb/Br) | SNAGCU | Level-1-260C-UNLIM | -40 to 125 | EB | Samples |
| TPS79918YZUT | ACTIVE | DSBGA | YZU | 5 | 250 | Green (RoHS & no Sb/Br) | SNAGCU | Level-1-260C-UNLIM | -40 to 125 | EB | Samples |
| TPS799195DRVR | ACTIVE | WSON | DRV | 6 | 3000 | Green (RoHS & no Sb/Br) | NIPDAU | Level-1-260C-UNLIM | -40 to 125 | BTP | Samples |
| TPS799195DRVRG4 | ACTIVE | WSON | DRV | 6 | 3000 | Green (RoHS & no Sb/Br) | NIPDAU | Level-1-260C-UNLIM | -40 to 125 | BTP | Samples |
| TPS799195DRVT | ACTIVE | WSON | DRV | 6 | 250 | Green (RoHS & no Sb/Br) | NIPDAU | Level-1-260C-UNLIM | -40 to 125 | BTP | Samples |
| TPS799195YZUR | ACTIVE | DSBGA | YZU | 5 | 3000 | Green (RoHS & no Sb/Br) | SNAGCU | Level-1-260C-UNLIM | -40 to 125 | AO | Samples |
| TPS799195YZUT | ACTIVE | DSBGA | YZU | 5 | 250 | Green (RoHS & no Sb/Br) | SNAGCU | Level-1-260C-UNLIM | -40 to 125 | AO | Samples |
| TPS79919YZUT | ACTIVE | DSBGA | YZU | 5 | 250 | Green (RoHS & no Sb/Br) | SNAGCU | Level-1-260C-UNLIM | -40 to 125 | F6 | Samples |
| TPS79920YZUT | ACTIVE | DSBGA | YZU | 5 | 250 | Green (RoHS & no Sb/Br) | SNAGCU | Level-1-260C-UNLIM | -40 to 125 | GA | Samples |
| TPS79921YZUR | ACTIVE | DSBGA | YZU | 5 | 3000 | Green (RoHS & no Sb/Br) | SNAGCU | Level-1-260C-UNLIM | -40 to 125 | G7 | Samples |
| TPS79925DDCR | ACTIVE | SOT-23-THIN | DDC | 5 | 3000 | Green (RoHS & no Sb/Br) | NIPDAU | Level-1-260C-UNLIM | -40 to 125 | AWW | Samples |
| TPS79925DDCT | ACTIVE | SOT-23-THIN | DDC | 5 | 250 | Green (RoHS & no Sb/Br) | NIPDAU | Level-1-260C-UNLIM | -40 to 125 | AWW | Samples |
| TPS79925YZUR | ACTIVE | DSBGA | YZU | 5 | 3000 | Green (RoHS & no Sb/Br) | SNAGCU | Level-1-260C-UNLIM | -40 to 125 | EC | Samples |
| TPS79925YZUT | ACTIVE | DSBGA | YZU | 5 | 250 | Green (RoHS & no Sb/Br) | SNAGCU | Level-1-260C-UNLIM | -40 to 125 | EC | Samples |

| Orderable Device | Status (1) | Package Type | Package Drawing | Pins | Package Qty | Eco Plan (2) | Lead/Ball Finish (6) | MSL Peak Temp (3) | Op Temp (°C) | Device Marking (4/5) | Samples |
|------------------|---------------|--------------|-----------------|------|-------------|-------------------------|-------------------------|----------------------|--------------|-------------------------|-------------------------|
| TPS79926YZUR | ACTIVE | DSBGA | YZU | 5 | 3000 | Green (RoHS & no Sb/Br) | SNAGCU | Level-1-260C-UNLIM | -40 to 125 | F3 | Samples |
| TPS79926YZUT | ACTIVE | DSBGA | YZU | 5 | 250 | Green (RoHS & no Sb/Br) | SNAGCU | Level-1-260C-UNLIM | -40 to 125 | F3 | Samples |
| TPS79927DDCR | ACTIVE | SOT-23-THIN | DDC | 5 | 3000 | Green (RoHS & no Sb/Br) | NIPDAU | Level-1-260C-UNLIM | -40 to 125 | BWE | Samples |
| TPS79927DDCT | ACTIVE | SOT-23-THIN | DDC | 5 | 250 | Green (RoHS & no Sb/Br) | NIPDAU | Level-1-260C-UNLIM | -40 to 125 | BWE | Samples |
| TPS79927DRVR | ACTIVE | WSON | DRV | 6 | 3000 | Green (RoHS & no Sb/Br) | NIPDAU | Level-1-260C-UNLIM | -40 to 125 | BPM | Samples |
| TPS79927DRVT | ACTIVE | WSON | DRV | 6 | 250 | Green (RoHS & no Sb/Br) | NIPDAU | Level-1-260C-UNLIM | -40 to 125 | BPM | Samples |
| TPS79927YZUT | ACTIVE | DSBGA | YZU | 5 | 250 | Green (RoHS & no Sb/Br) | SNAGCU | Level-1-260C-UNLIM | -40 to 125 | F5 | Samples |
| TPS799285DDCR | ACTIVE | SOT-23-THIN | DDC | 5 | 3000 | Green (RoHS & no Sb/Br) | NIPDAU | Level-1-260C-UNLIM | -40 to 125 | AXY | Samples |
| TPS799285DDCRG4 | ACTIVE | SOT-23-THIN | DDC | 5 | 3000 | Green (RoHS & no Sb/Br) | NIPDAU | Level-1-260C-UNLIM | -40 to 125 | AXY | Samples |
| TPS799285DDCT | ACTIVE | SOT-23-THIN | DDC | 5 | 250 | Green (RoHS & no Sb/Br) | NIPDAU | Level-1-260C-UNLIM | -40 to 125 | AXY | Samples |
| TPS799285DDCTG4 | ACTIVE | SOT-23-THIN | DDC | 5 | 250 | Green (RoHS & no Sb/Br) | NIPDAU | Level-1-260C-UNLIM | -40 to 125 | AXY | Samples |
| TPS799285DRVR | ACTIVE | WSON | DRV | 6 | 3000 | Green (RoHS & no Sb/Br) | NIPDAU | Level-1-260C-UNLIM | -40 to 125 | BST | Samples |
| TPS799285DRVT | ACTIVE | WSON | DRV | 6 | 250 | Green (RoHS & no Sb/Br) | NIPDAU | Level-1-260C-UNLIM | -40 to 125 | BST | Samples |
| TPS799285YZUR | ACTIVE | DSBGA | YZU | 5 | 3000 | Green (RoHS & no Sb/Br) | SNAGCU | Level-1-260C-UNLIM | -40 to 125 | EE | Samples |
| TPS79928DDCR | ACTIVE | SOT-23-THIN | DDC | 5 | 3000 | Green (RoHS & no Sb/Br) | NIPDAU | Level-1-260C-UNLIM | -40 to 125 | AWX | Samples |
| TPS79928DDCT | ACTIVE | SOT-23-THIN | DDC | 5 | 250 | Green (RoHS & no Sb/Br) | NIPDAU | Level-1-260C-UNLIM | -40 to 125 | AWX | Samples |
| TPS79928DRVR | ACTIVE | WSON | DRV | 6 | 3000 | Green (RoHS & no Sb/Br) | NIPDAU | Level-1-260C-UNLIM | -40 to 125 | AWX | Samples |
| TPS79928DRVT | ACTIVE | WSON | DRV | 6 | 250 | Green (RoHS & no Sb/Br) | NIPDAU | Level-1-260C-UNLIM | -40 to 125 | AWX | Samples |

| Orderable Device | Status (1) | Package Type | Package Drawing | Pins | Package Qty | Eco Plan (2) | Lead/Ball Finish (6) | MSL Peak Temp (3) | Op Temp (°C) | Device Marking (4/5) | Samples |
|------------------|---------------|--------------|-----------------|------|-------------|-------------------------|-------------------------|----------------------|--------------|-------------------------|-------------------------|
| TPS79928YZUR | ACTIVE | DSBGA | YZU | 5 | 3000 | Green (RoHS & no Sb/Br) | SNAGCU | Level-1-260C-UNLIM | -40 to 125 | ED | Samples |
| TPS79928YZUT | ACTIVE | DSBGA | YZU | 5 | 250 | Green (RoHS & no Sb/Br) | SNAGCU | Level-1-260C-UNLIM | -40 to 125 | ED | Samples |
| TPS79930DDCR | ACTIVE | SOT-23-THIN | DDC | 5 | 3000 | Green (RoHS & no Sb/Br) | NIPDAU | Level-1-260C-UNLIM | -40 to 125 | AXZ | Samples |
| TPS79930DDCRG4 | ACTIVE | SOT-23-THIN | DDC | 5 | 3000 | Green (RoHS & no Sb/Br) | NIPDAU | Level-1-260C-UNLIM | -40 to 125 | AXZ | Samples |
| TPS79930DDCT | ACTIVE | SOT-23-THIN | DDC | 5 | 250 | Green (RoHS & no Sb/Br) | NIPDAU | Level-1-260C-UNLIM | -40 to 125 | AXZ | Samples |
| TPS79930DDCTG4 | ACTIVE | SOT-23-THIN | DDC | 5 | 250 | Green (RoHS & no Sb/Br) | NIPDAU | Level-1-260C-UNLIM | -40 to 125 | AXZ | Samples |
| TPS79930YZUR | ACTIVE | DSBGA | YZU | 5 | 3000 | Green (RoHS & no Sb/Br) | SNAGCU | Level-1-260C-UNLIM | -40 to 125 | EF | Samples |
| TPS79930YZUT | ACTIVE | DSBGA | YZU | 5 | 250 | Green (RoHS & no Sb/Br) | SNAGCU | Level-1-260C-UNLIM | -40 to 125 | EF | Samples |
| TPS799315DDCR | ACTIVE | SOT-23-THIN | DDC | 5 | 3000 | Green (RoHS & no Sb/Br) | NIPDAU | Level-1-260C-UNLIM | -40 to 125 | CGQ | Samples |
| TPS799315DDCRG4 | ACTIVE | SOT-23-THIN | DDC | 5 | 3000 | Green (RoHS & no Sb/Br) | NIPDAU | Level-1-260C-UNLIM | -40 to 125 | CGQ | Samples |
| TPS799315DDCT | ACTIVE | SOT-23-THIN | DDC | 5 | 250 | Green (RoHS & no Sb/Br) | NIPDAU | Level-1-260C-UNLIM | -40 to 125 | CGQ | Samples |
| TPS799315YZUR | ACTIVE | DSBGA | YZU | 5 | 3000 | Green (RoHS & no Sb/Br) | SNAGCU | Level-1-260C-UNLIM | -40 to 125 | GP | Samples |
| TPS799315YZUT | ACTIVE | DSBGA | YZU | 5 | 250 | Green (RoHS & no Sb/Br) | SNAGCU | Level-1-260C-UNLIM | -40 to 125 | GP | Samples |
| TPS79932YZUR | ACTIVE | DSBGA | YZU | 5 | 3000 | Green (RoHS & no Sb/Br) | SNAGCU | Level-1-260C-UNLIM | -40 to 125 | (F4, FY) | Samples |
| TPS79933DDCR | ACTIVE | SOT-23-THIN | DDC | 5 | 3000 | Green (RoHS & no Sb/Br) | NIPDAU | Level-1-260C-UNLIM | -40 to 125 | AXX | Samples |
| TPS79933DDCRG4 | ACTIVE | SOT-23-THIN | DDC | 5 | 3000 | Green (RoHS & no Sb/Br) | NIPDAU | Level-1-260C-UNLIM | -40 to 125 | AXX | Samples |
| TPS79933DDCT | ACTIVE | SOT-23-THIN | DDC | 5 | 250 | Green (RoHS & no Sb/Br) | NIPDAU | Level-1-260C-UNLIM | -40 to 125 | AXX | Samples |
| TPS79933DDCTG4 | ACTIVE | SOT-23-THIN | DDC | 5 | 250 | Green (RoHS & no Sb/Br) | NIPDAU | Level-1-260C-UNLIM | -40 to 125 | AXX | Samples |

| Orderable Device | Status (1) | Package Type | Package Drawing | Pins | Package Qty | Eco Plan (2) | Lead/Ball Finish (6) | MSL Peak Temp (3) | Op Temp (°C) | Device Marking (4/5) | Samples |
|------------------|---------------|--------------|-----------------|------|-------------|-------------------------|-------------------------|----------------------|--------------|-------------------------|-------------------------|
| TPS79933DRVR | ACTIVE | WSON | DRV | 6 | 3000 | Green (RoHS & no Sb/Br) | NIPDAU | Level-1-260C-UNLIM | -40 to 125 | AXX | Samples |
| TPS79933DRVRG4 | ACTIVE | WSON | DRV | 6 | 3000 | Green (RoHS & no Sb/Br) | NIPDAU | Level-1-260C-UNLIM | -40 to 125 | AXX | Samples |
| TPS79933DRVT | ACTIVE | WSON | DRV | 6 | 250 | Green (RoHS & no Sb/Br) | NIPDAU | Level-1-260C-UNLIM | -40 to 125 | AXX | Samples |
| TPS79933DRVTG4 | ACTIVE | WSON | DRV | 6 | 250 | Green (RoHS & no Sb/Br) | NIPDAU | Level-1-260C-UNLIM | -40 to 125 | AXX | Samples |
| TPS79933YZUR | ACTIVE | DSBGA | YZU | 5 | 3000 | Green (RoHS & no Sb/Br) | SNAGCU | Level-1-260C-UNLIM | -40 to 125 | EG | Samples |
| TPS79933YZUT | ACTIVE | DSBGA | YZU | 5 | 250 | Green (RoHS & no Sb/Br) | SNAGCU | Level-1-260C-UNLIM | -40 to 125 | EG | Samples |
| TPS79942DDCR | ACTIVE | SOT-23-THIN | DDC | 5 | 3000 | Green (RoHS & no Sb/Br) | NIPDAU | Level-1-260C-UNLIM | -40 to 125 | CJQ | Samples |
| TPS79942DDCRG4 | ACTIVE | SOT-23-THIN | DDC | 5 | 3000 | Green (RoHS & no Sb/Br) | NIPDAU | Level-1-260C-UNLIM | -40 to 125 | CJQ | Samples |
| TPS79942DDCT | ACTIVE | SOT-23-THIN | DDC | 5 | 250 | Green (RoHS & no Sb/Br) | NIPDAU | Level-1-260C-UNLIM | -40 to 125 | CJQ | Samples |
| TPS79945YZUR | ACTIVE | DSBGA | YZU | 5 | 3000 | Green (RoHS & no Sb/Br) | SNAGCU | Level-1-260C-UNLIM | -40 to 125 | FK | Samples |
| TPS79945YZUT | ACTIVE | DSBGA | YZU | 5 | 250 | Green (RoHS & no Sb/Br) | SNAGCU | Level-1-260C-UNLIM | -40 to 125 | FK | Samples |

(1) The marketing status values are defined as follows:

ACTIVE: Product device recommended for new designs.

LIFEBUY: TI has announced that the device will be discontinued, and a lifetime-buy period is in effect.

NRND: Not recommended for new designs. Device is in production to support existing customers, but TI does not recommend using this part in a new design.

PREVIEW: Device has been announced but is not in production. Samples may or may not be available.

OBSELETE: TI has discontinued the production of the device.

(2) **RoHS:** TI defines "RoHS" to mean semiconductor products that are compliant with the current EU RoHS requirements for all 10 RoHS substances, including the requirement that RoHS substance do not exceed 0.1% by weight in homogeneous materials. Where designed to be soldered at high temperatures, "RoHS" products are suitable for use in specified lead-free processes. TI may reference these types of products as "Pb-Free".

RoHS Exempt: TI defines "RoHS Exempt" to mean products that contain lead but are compliant with EU RoHS pursuant to a specific EU RoHS exemption.

Green: TI defines "Green" to mean the content of Chlorine (Cl) and Bromine (Br) based flame retardants meet JS709B low halogen requirements of <=1000ppm threshold. Antimony trioxide based flame retardants must also meet the <=1000ppm threshold requirement.

(3) MSL, Peak Temp. - The Moisture Sensitivity Level rating according to the JEDEC industry standard classifications, and peak solder temperature.

(4) There may be additional marking, which relates to the logo, the lot trace code information, or the environmental category on the device.

(5) Multiple Device Markings will be inside parentheses. Only one Device Marking contained in parentheses and separated by a "~" will appear on a device. If a line is indented then it is a continuation of the previous line and the two combined represent the entire Device Marking for that device.

(6) Lead/Ball Finish - Orderable Devices may have multiple material finish options. Finish options are separated by a vertical ruled line. Lead/Ball Finish values may wrap to two lines if the finish value exceeds the maximum column width.

Important Information and Disclaimer:The information provided on this page represents TI's knowledge and belief as of the date that it is provided. TI bases its knowledge and belief on information provided by third parties, and makes no representation or warranty as to the accuracy of such information. Efforts are underway to better integrate information from third parties. TI has taken and continues to take reasonable steps to provide representative and accurate information but may not have conducted destructive testing or chemical analysis on incoming materials and chemicals. TI and TI suppliers consider certain information to be proprietary, and thus CAS numbers and other limited information may not be available for release.

In no event shall TI's liability arising out of such information exceed the total purchase price of the TI part(s) at issue in this document sold by TI to Customer on an annual basis.

OTHER QUALIFIED VERSIONS OF TPS799 :

- Automotive: [TPS799-Q1](#)

NOTE: Qualified Version Definitions:

- Automotive - Q100 devices qualified for high-reliability automotive applications targeting zero defects

TAPE AND REEL INFORMATION



QUADRANT ASSIGNMENTS FOR PIN 1 ORIENTATION IN TAPE



*All dimensions are nominal

| Device | Package Type | Package Drawing | Pins | SPQ | Reel Diameter (mm) | Reel Width W1 (mm) | A0 (mm) | B0 (mm) | K0 (mm) | P1 (mm) | W (mm) | Pin1 Quadrant |
|---------------|--------------|-----------------|------|------|--------------------|--------------------|---------|---------|---------|---------|--------|---------------|
| TPS79901DDCR | SOT-23-THIN | DDC | 5 | 3000 | 180.0 | 8.4 | 3.1 | 3.05 | 1.1 | 4.0 | 8.0 | Q3 |
| TPS79901DDCR | SOT-23-THIN | DDC | 5 | 3000 | 179.0 | 8.4 | 3.2 | 3.2 | 1.4 | 4.0 | 8.0 | Q3 |
| TPS79901DDCT | SOT-23-THIN | DDC | 5 | 250 | 179.0 | 8.4 | 3.2 | 3.2 | 1.4 | 4.0 | 8.0 | Q3 |
| TPS79901DDCT | SOT-23-THIN | DDC | 5 | 250 | 180.0 | 8.4 | 3.1 | 3.05 | 1.1 | 4.0 | 8.0 | Q3 |
| TPS79901DRVR | WSO | DRV | 6 | 3000 | 179.0 | 8.4 | 2.2 | 2.2 | 1.2 | 4.0 | 8.0 | Q2 |
| TPS79901DRVT | WSO | DRV | 6 | 250 | 179.0 | 8.4 | 2.2 | 2.2 | 1.2 | 4.0 | 8.0 | Q2 |
| TPS79901YZUR | DSBGA | YZU | 5 | 3000 | 180.0 | 8.4 | 1.07 | 1.42 | 0.74 | 4.0 | 8.0 | Q1 |
| TPS79901YZUT | DSBGA | YZU | 5 | 250 | 180.0 | 8.4 | 1.07 | 1.42 | 0.74 | 4.0 | 8.0 | Q1 |
| TPS799125YZUR | DSBGA | YZU | 5 | 3000 | 180.0 | 8.4 | 1.07 | 1.42 | 0.74 | 4.0 | 8.0 | Q1 |
| TPS799125YZUT | DSBGA | YZU | 5 | 250 | 180.0 | 8.4 | 1.07 | 1.42 | 0.74 | 4.0 | 8.0 | Q1 |
| TPS79912DDCR | SOT-23-THIN | DDC | 5 | 3000 | 179.0 | 8.4 | 3.2 | 3.2 | 1.4 | 4.0 | 8.0 | Q3 |
| TPS79912DDCT | SOT-23-THIN | DDC | 5 | 250 | 179.0 | 8.4 | 3.2 | 3.2 | 1.4 | 4.0 | 8.0 | Q3 |
| TPS79912DRVR | WSO | DRV | 6 | 3000 | 179.0 | 8.4 | 2.2 | 2.2 | 1.2 | 4.0 | 8.0 | Q2 |
| TPS79912DRVT | WSO | DRV | 6 | 250 | 179.0 | 8.4 | 2.2 | 2.2 | 1.2 | 4.0 | 8.0 | Q2 |

| Device | Package Type | Package Drawing | Pins | SPQ | Reel Diameter (mm) | Reel Width W1 (mm) | A0 (mm) | B0 (mm) | K0 (mm) | P1 (mm) | W (mm) | Pin1 Quadrant |
|---------------|--------------|-----------------|------|------|--------------------|--------------------|---------|---------|---------|---------|--------|---------------|
| TPS79912YZUR | DSBGA | YZU | 5 | 3000 | 180.0 | 8.4 | 1.07 | 1.42 | 0.74 | 4.0 | 8.0 | Q1 |
| TPS79912YZUT | DSBGA | YZU | 5 | 250 | 180.0 | 8.4 | 1.07 | 1.42 | 0.74 | 4.0 | 8.0 | Q1 |
| TPS79913DDCR | SOT-23-THIN | DDC | 5 | 3000 | 179.0 | 8.4 | 3.2 | 3.2 | 1.4 | 4.0 | 8.0 | Q3 |
| TPS79913DDCT | SOT-23-THIN | DDC | 5 | 250 | 179.0 | 8.4 | 3.2 | 3.2 | 1.4 | 4.0 | 8.0 | Q3 |
| TPS79913YZUR | DSBGA | YZU | 5 | 3000 | 180.0 | 8.4 | 1.07 | 1.42 | 0.74 | 4.0 | 8.0 | Q1 |
| TPS79915DDCR | SOT-23-THIN | DDC | 5 | 3000 | 179.0 | 8.4 | 3.2 | 3.2 | 1.4 | 4.0 | 8.0 | Q3 |
| TPS79915DDCT | SOT-23-THIN | DDC | 5 | 250 | 179.0 | 8.4 | 3.2 | 3.2 | 1.4 | 4.0 | 8.0 | Q3 |
| TPS79915YZUR | DSBGA | YZU | 5 | 3000 | 180.0 | 8.4 | 1.07 | 1.42 | 0.74 | 4.0 | 8.0 | Q1 |
| TPS79915YZUT | DSBGA | YZU | 5 | 250 | 180.0 | 8.4 | 1.07 | 1.42 | 0.74 | 4.0 | 8.0 | Q1 |
| TPS799185DDCR | SOT-23-THIN | DDC | 5 | 3000 | 179.0 | 8.4 | 3.2 | 3.2 | 1.4 | 4.0 | 8.0 | Q3 |
| TPS799185DDCT | SOT-23-THIN | DDC | 5 | 250 | 179.0 | 8.4 | 3.2 | 3.2 | 1.4 | 4.0 | 8.0 | Q3 |
| TPS799185YZUR | DSBGA | YZU | 5 | 3000 | 180.0 | 8.4 | 1.07 | 1.42 | 0.74 | 4.0 | 8.0 | Q1 |
| TPS799185YZUT | DSBGA | YZU | 5 | 250 | 180.0 | 8.4 | 1.07 | 1.42 | 0.74 | 4.0 | 8.0 | Q1 |
| TPS79918DDCR | SOT-23-THIN | DDC | 5 | 3000 | 179.0 | 8.4 | 3.2 | 3.2 | 1.4 | 4.0 | 8.0 | Q3 |
| TPS79918DDCT | SOT-23-THIN | DDC | 5 | 250 | 179.0 | 8.4 | 3.2 | 3.2 | 1.4 | 4.0 | 8.0 | Q3 |
| TPS79918DRVR | WSON | DRV | 6 | 3000 | 179.0 | 8.4 | 2.2 | 2.2 | 1.2 | 4.0 | 8.0 | Q2 |
| TPS79918DRVT | WSON | DRV | 6 | 250 | 179.0 | 8.4 | 2.2 | 2.2 | 1.2 | 4.0 | 8.0 | Q2 |
| TPS79918YZUR | DSBGA | YZU | 5 | 3000 | 180.0 | 8.4 | 1.07 | 1.42 | 0.74 | 4.0 | 8.0 | Q1 |
| TPS79918YZUT | DSBGA | YZU | 5 | 250 | 180.0 | 8.4 | 1.07 | 1.42 | 0.74 | 4.0 | 8.0 | Q1 |
| TPS799195DRVR | WSON | DRV | 6 | 3000 | 179.0 | 8.4 | 2.2 | 2.2 | 1.2 | 4.0 | 8.0 | Q2 |
| TPS799195DRVT | WSON | DRV | 6 | 250 | 179.0 | 8.4 | 2.2 | 2.2 | 1.2 | 4.0 | 8.0 | Q2 |
| TPS799195YZUR | DSBGA | YZU | 5 | 3000 | 180.0 | 8.4 | 1.07 | 1.42 | 0.74 | 4.0 | 8.0 | Q1 |
| TPS799195YZUT | DSBGA | YZU | 5 | 250 | 180.0 | 8.4 | 1.07 | 1.42 | 0.74 | 4.0 | 8.0 | Q1 |
| TPS79919YZUT | DSBGA | YZU | 5 | 250 | 180.0 | 8.4 | 1.07 | 1.42 | 0.74 | 4.0 | 8.0 | Q1 |
| TPS79920YZUT | DSBGA | YZU | 5 | 250 | 180.0 | 8.4 | 1.07 | 1.42 | 0.74 | 4.0 | 8.0 | Q1 |
| TPS79921YZUR | DSBGA | YZU | 5 | 3000 | 180.0 | 8.4 | 1.07 | 1.42 | 0.74 | 4.0 | 8.0 | Q1 |
| TPS79925DDCR | SOT-23-THIN | DDC | 5 | 3000 | 179.0 | 8.4 | 3.2 | 3.2 | 1.4 | 4.0 | 8.0 | Q3 |
| TPS79925DDCT | SOT-23-THIN | DDC | 5 | 250 | 179.0 | 8.4 | 3.2 | 3.2 | 1.4 | 4.0 | 8.0 | Q3 |
| TPS79925YZUR | DSBGA | YZU | 5 | 3000 | 180.0 | 8.4 | 1.07 | 1.42 | 0.74 | 4.0 | 8.0 | Q1 |
| TPS79925YZUT | DSBGA | YZU | 5 | 250 | 180.0 | 8.4 | 1.07 | 1.42 | 0.74 | 4.0 | 8.0 | Q1 |
| TPS79926YZUR | DSBGA | YZU | 5 | 3000 | 180.0 | 8.4 | 1.07 | 1.42 | 0.74 | 4.0 | 8.0 | Q1 |
| TPS79926YZUT | DSBGA | YZU | 5 | 250 | 180.0 | 8.4 | 1.07 | 1.42 | 0.74 | 4.0 | 8.0 | Q1 |
| TPS79927DDCR | SOT-23-THIN | DDC | 5 | 3000 | 179.0 | 8.4 | 3.2 | 3.2 | 1.4 | 4.0 | 8.0 | Q3 |
| TPS79927DDCT | SOT-23-THIN | DDC | 5 | 250 | 179.0 | 8.4 | 3.2 | 3.2 | 1.4 | 4.0 | 8.0 | Q3 |

| Device | Package Type | Package Drawing | Pins | SPQ | Reel Diameter (mm) | Reel Width W1 (mm) | A0 (mm) | B0 (mm) | K0 (mm) | P1 (mm) | W (mm) | Pin1 Quadrant |
|---------------|--------------|-----------------|------|------|--------------------|--------------------|---------|---------|---------|---------|--------|---------------|
| TPS79927DRVR | WSON | DRV | 6 | 3000 | 179.0 | 8.4 | 2.2 | 2.2 | 1.2 | 4.0 | 8.0 | Q2 |
| TPS79927DRVT | WSON | DRV | 6 | 250 | 179.0 | 8.4 | 2.2 | 2.2 | 1.2 | 4.0 | 8.0 | Q2 |
| TPS79927YZUT | DSBGA | YZU | 5 | 250 | 180.0 | 8.4 | 1.07 | 1.42 | 0.74 | 4.0 | 8.0 | Q1 |
| TPS799285DDCR | SOT-23-THIN | DDC | 5 | 3000 | 179.0 | 8.4 | 3.2 | 3.2 | 1.4 | 4.0 | 8.0 | Q3 |
| TPS799285DDCT | SOT-23-THIN | DDC | 5 | 250 | 179.0 | 8.4 | 3.2 | 3.2 | 1.4 | 4.0 | 8.0 | Q3 |
| TPS799285DRVR | WSON | DRV | 6 | 3000 | 179.0 | 8.4 | 2.2 | 2.2 | 1.2 | 4.0 | 8.0 | Q2 |
| TPS799285DRVT | WSON | DRV | 6 | 250 | 179.0 | 8.4 | 2.2 | 2.2 | 1.2 | 4.0 | 8.0 | Q2 |
| TPS799285YZUR | DSBGA | YZU | 5 | 3000 | 180.0 | 8.4 | 1.07 | 1.42 | 0.74 | 4.0 | 8.0 | Q1 |
| TPS79928DDCR | SOT-23-THIN | DDC | 5 | 3000 | 179.0 | 8.4 | 3.2 | 3.2 | 1.4 | 4.0 | 8.0 | Q3 |
| TPS79928DDCT | SOT-23-THIN | DDC | 5 | 250 | 179.0 | 8.4 | 3.2 | 3.2 | 1.4 | 4.0 | 8.0 | Q3 |
| TPS79928DRVR | WSON | DRV | 6 | 3000 | 179.0 | 8.4 | 2.2 | 2.2 | 1.2 | 4.0 | 8.0 | Q2 |
| TPS79928DRVT | WSON | DRV | 6 | 250 | 179.0 | 8.4 | 2.2 | 2.2 | 1.2 | 4.0 | 8.0 | Q2 |
| TPS79928YZUR | DSBGA | YZU | 5 | 3000 | 180.0 | 8.4 | 1.07 | 1.42 | 0.74 | 4.0 | 8.0 | Q1 |
| TPS79928YZUT | DSBGA | YZU | 5 | 250 | 180.0 | 8.4 | 1.07 | 1.42 | 0.74 | 4.0 | 8.0 | Q1 |
| TPS79930DDCR | SOT-23-THIN | DDC | 5 | 3000 | 179.0 | 8.4 | 3.2 | 3.2 | 1.4 | 4.0 | 8.0 | Q3 |
| TPS79930DDCR | SOT-23-THIN | DDC | 5 | 3000 | 180.0 | 8.4 | 3.1 | 3.05 | 1.1 | 4.0 | 8.0 | Q3 |
| TPS79930DDCT | SOT-23-THIN | DDC | 5 | 250 | 179.0 | 8.4 | 3.2 | 3.2 | 1.4 | 4.0 | 8.0 | Q3 |
| TPS79930YZUR | DSBGA | YZU | 5 | 3000 | 180.0 | 8.4 | 1.07 | 1.42 | 0.74 | 4.0 | 8.0 | Q1 |
| TPS79930YZUT | DSBGA | YZU | 5 | 250 | 180.0 | 8.4 | 1.07 | 1.42 | 0.74 | 4.0 | 8.0 | Q1 |
| TPS799315DDCR | SOT-23-THIN | DDC | 5 | 3000 | 179.0 | 8.4 | 3.2 | 3.2 | 1.4 | 4.0 | 8.0 | Q3 |
| TPS799315DDCT | SOT-23-THIN | DDC | 5 | 250 | 179.0 | 8.4 | 3.2 | 3.2 | 1.4 | 4.0 | 8.0 | Q3 |
| TPS799315YZUR | DSBGA | YZU | 5 | 3000 | 180.0 | 8.4 | 1.07 | 1.42 | 0.74 | 4.0 | 8.0 | Q1 |
| TPS799315YZUT | DSBGA | YZU | 5 | 250 | 180.0 | 8.4 | 1.07 | 1.42 | 0.74 | 4.0 | 8.0 | Q1 |
| TPS79932YZUR | DSBGA | YZU | 5 | 3000 | 180.0 | 8.4 | 1.07 | 1.42 | 0.74 | 4.0 | 8.0 | Q1 |
| TPS79933DDCR | SOT-23-THIN | DDC | 5 | 3000 | 179.0 | 8.4 | 3.2 | 3.2 | 1.4 | 4.0 | 8.0 | Q3 |
| TPS79933DDCR | SOT-23-THIN | DDC | 5 | 3000 | 180.0 | 8.4 | 3.1 | 3.05 | 1.1 | 4.0 | 8.0 | Q3 |
| TPS79933DDCT | SOT-23-THIN | DDC | 5 | 250 | 180.0 | 8.4 | 3.1 | 3.05 | 1.1 | 4.0 | 8.0 | Q3 |
| TPS79933DDCT | SOT-23-THIN | DDC | 5 | 250 | 179.0 | 8.4 | 3.2 | 3.2 | 1.4 | 4.0 | 8.0 | Q3 |
| TPS79933DRVR | WSON | DRV | 6 | 3000 | 179.0 | 8.4 | 2.2 | 2.2 | 1.2 | 4.0 | 8.0 | Q2 |
| TPS79933DRVT | WSON | DRV | 6 | 250 | 179.0 | 8.4 | 2.2 | 2.2 | 1.2 | 4.0 | 8.0 | Q2 |
| TPS79933YZUR | DSBGA | YZU | 5 | 3000 | 180.0 | 8.4 | 1.07 | 1.42 | 0.74 | 4.0 | 8.0 | Q1 |
| TPS79933YZUT | DSBGA | YZU | 5 | 250 | 180.0 | 8.4 | 1.07 | 1.42 | 0.74 | 4.0 | 8.0 | Q1 |
| TPS79942DDCR | SOT-23-THIN | DDC | 5 | 3000 | 179.0 | 8.4 | 3.2 | 3.2 | 1.4 | 4.0 | 8.0 | Q3 |

| Device | Package Type | Package Drawing | Pins | SPQ | Reel Diameter (mm) | Reel Width W1 (mm) | A0 (mm) | B0 (mm) | K0 (mm) | P1 (mm) | W (mm) | Pin1 Quadrant |
|--------------|--------------|-----------------|------|------|--------------------|--------------------|---------|---------|---------|---------|--------|---------------|
| TPS79942DDCT | SOT-23-THIN | DDC | 5 | 250 | 179.0 | 8.4 | 3.2 | 3.2 | 1.4 | 4.0 | 8.0 | Q3 |
| TPS79945YZUR | DSBGA | YZU | 5 | 3000 | 180.0 | 8.4 | 1.07 | 1.42 | 0.74 | 4.0 | 8.0 | Q1 |
| TPS79945YZUT | DSBGA | YZU | 5 | 250 | 180.0 | 8.4 | 1.07 | 1.42 | 0.74 | 4.0 | 8.0 | Q1 |

TAPE AND REEL BOX DIMENSIONS

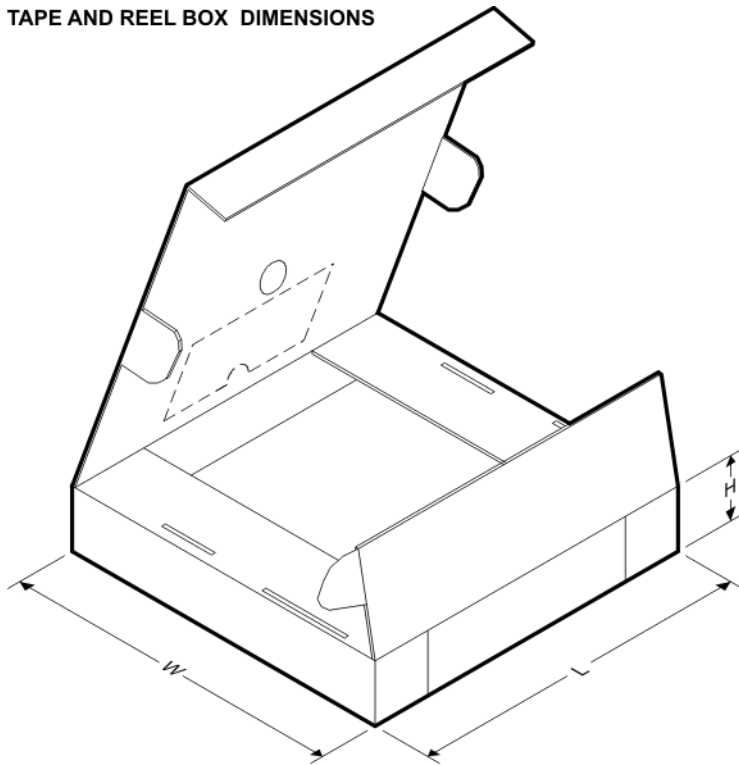

*All dimensions are nominal

| Device | Package Type | Package Drawing | Pins | SPQ | Length (mm) | Width (mm) | Height (mm) |
|---------------|--------------|-----------------|------|------|-------------|------------|-------------|
| TPS79901DDCR | SOT-23-THIN | DDC | 5 | 3000 | 183.0 | 183.0 | 20.0 |
| TPS79901DDCR | SOT-23-THIN | DDC | 5 | 3000 | 203.0 | 203.0 | 35.0 |
| TPS79901DDCT | SOT-23-THIN | DDC | 5 | 250 | 203.0 | 203.0 | 35.0 |
| TPS79901DDCT | SOT-23-THIN | DDC | 5 | 250 | 183.0 | 183.0 | 20.0 |
| TPS79901DRVR | WSON | DRV | 6 | 3000 | 203.0 | 203.0 | 35.0 |
| TPS79901DRVT | WSON | DRV | 6 | 250 | 203.0 | 203.0 | 35.0 |
| TPS79901YZUR | DSBGA | YZU | 5 | 3000 | 182.0 | 182.0 | 20.0 |
| TPS79901YZUT | DSBGA | YZU | 5 | 250 | 182.0 | 182.0 | 20.0 |
| TPS799125YZUR | DSBGA | YZU | 5 | 3000 | 182.0 | 182.0 | 20.0 |
| TPS799125YZUT | DSBGA | YZU | 5 | 250 | 182.0 | 182.0 | 20.0 |
| TPS79912DDCR | SOT-23-THIN | DDC | 5 | 3000 | 203.0 | 203.0 | 35.0 |
| TPS79912DDCT | SOT-23-THIN | DDC | 5 | 250 | 203.0 | 203.0 | 35.0 |
| TPS79912DRVR | WSON | DRV | 6 | 3000 | 203.0 | 203.0 | 35.0 |

| Device | Package Type | Package Drawing | Pins | SPQ | Length (mm) | Width (mm) | Height (mm) |
|---------------|--------------|-----------------|------|------|-------------|------------|-------------|
| TPS79912DRV | WSON | DRV | 6 | 250 | 203.0 | 203.0 | 35.0 |
| TPS79912YZUR | DSBGA | YZU | 5 | 3000 | 182.0 | 182.0 | 20.0 |
| TPS79912YZUT | DSBGA | YZU | 5 | 250 | 210.0 | 185.0 | 35.0 |
| TPS79913DDCR | SOT-23-THIN | DDC | 5 | 3000 | 203.0 | 203.0 | 35.0 |
| TPS79913DDCT | SOT-23-THIN | DDC | 5 | 250 | 203.0 | 203.0 | 35.0 |
| TPS79913YZUR | DSBGA | YZU | 5 | 3000 | 210.0 | 185.0 | 35.0 |
| TPS79915DDCR | SOT-23-THIN | DDC | 5 | 3000 | 203.0 | 203.0 | 35.0 |
| TPS79915DDCT | SOT-23-THIN | DDC | 5 | 250 | 203.0 | 203.0 | 35.0 |
| TPS79915YZUR | DSBGA | YZU | 5 | 3000 | 182.0 | 182.0 | 20.0 |
| TPS79915YZUT | DSBGA | YZU | 5 | 250 | 210.0 | 185.0 | 35.0 |
| TPS799185DDCR | SOT-23-THIN | DDC | 5 | 3000 | 203.0 | 203.0 | 35.0 |
| TPS799185DDCT | SOT-23-THIN | DDC | 5 | 250 | 203.0 | 203.0 | 35.0 |
| TPS799185YZUR | DSBGA | YZU | 5 | 3000 | 182.0 | 182.0 | 20.0 |
| TPS799185YZUT | DSBGA | YZU | 5 | 250 | 182.0 | 182.0 | 20.0 |
| TPS79918DDCR | SOT-23-THIN | DDC | 5 | 3000 | 203.0 | 203.0 | 35.0 |
| TPS79918DDCT | SOT-23-THIN | DDC | 5 | 250 | 203.0 | 203.0 | 35.0 |
| TPS79918DRV | WSON | DRV | 6 | 3000 | 203.0 | 203.0 | 35.0 |
| TPS79918DRV | WSON | DRV | 6 | 250 | 203.0 | 203.0 | 35.0 |
| TPS79918YZUR | DSBGA | YZU | 5 | 3000 | 182.0 | 182.0 | 20.0 |
| TPS79918YZUT | DSBGA | YZU | 5 | 250 | 182.0 | 182.0 | 20.0 |
| TPS799195DRV | WSON | DRV | 6 | 3000 | 203.0 | 203.0 | 35.0 |
| TPS799195DRV | WSON | DRV | 6 | 250 | 203.0 | 203.0 | 35.0 |
| TPS799195YZUR | DSBGA | YZU | 5 | 3000 | 182.0 | 182.0 | 20.0 |
| TPS799195YZUT | DSBGA | YZU | 5 | 250 | 182.0 | 182.0 | 20.0 |
| TPS79919YZUT | DSBGA | YZU | 5 | 250 | 210.0 | 185.0 | 35.0 |
| TPS79920YZUT | DSBGA | YZU | 5 | 250 | 210.0 | 185.0 | 35.0 |
| TPS79921YZUR | DSBGA | YZU | 5 | 3000 | 210.0 | 185.0 | 35.0 |
| TPS79925DDCR | SOT-23-THIN | DDC | 5 | 3000 | 203.0 | 203.0 | 35.0 |
| TPS79925DDCT | SOT-23-THIN | DDC | 5 | 250 | 203.0 | 203.0 | 35.0 |
| TPS79925YZUR | DSBGA | YZU | 5 | 3000 | 210.0 | 185.0 | 35.0 |
| TPS79925YZUT | DSBGA | YZU | 5 | 250 | 182.0 | 182.0 | 20.0 |
| TPS79926YZUR | DSBGA | YZU | 5 | 3000 | 182.0 | 182.0 | 20.0 |
| TPS79926YZUT | DSBGA | YZU | 5 | 250 | 182.0 | 182.0 | 20.0 |
| TPS79927DDCR | SOT-23-THIN | DDC | 5 | 3000 | 203.0 | 203.0 | 35.0 |
| TPS79927DDCT | SOT-23-THIN | DDC | 5 | 250 | 203.0 | 203.0 | 35.0 |
| TPS79927DRV | WSON | DRV | 6 | 3000 | 203.0 | 203.0 | 35.0 |
| TPS79927DRV | WSON | DRV | 6 | 250 | 203.0 | 203.0 | 35.0 |
| TPS79927YZUT | DSBGA | YZU | 5 | 250 | 210.0 | 185.0 | 35.0 |
| TPS799285DDCR | SOT-23-THIN | DDC | 5 | 3000 | 203.0 | 203.0 | 35.0 |
| TPS799285DDCT | SOT-23-THIN | DDC | 5 | 250 | 203.0 | 203.0 | 35.0 |
| TPS799285DRV | WSON | DRV | 6 | 3000 | 203.0 | 203.0 | 35.0 |
| TPS799285DRV | WSON | DRV | 6 | 250 | 203.0 | 203.0 | 35.0 |
| TPS799285YZUR | DSBGA | YZU | 5 | 3000 | 210.0 | 185.0 | 35.0 |
| TPS79928DDCR | SOT-23-THIN | DDC | 5 | 3000 | 203.0 | 203.0 | 35.0 |

| Device | Package Type | Package Drawing | Pins | SPQ | Length (mm) | Width (mm) | Height (mm) |
|---------------|--------------|-----------------|------|------|-------------|------------|-------------|
| TPS79928DDCT | SOT-23-THIN | DDC | 5 | 250 | 203.0 | 203.0 | 35.0 |
| TPS79928DRVR | WSON | DRV | 6 | 3000 | 203.0 | 203.0 | 35.0 |
| TPS79928DRVT | WSON | DRV | 6 | 250 | 203.0 | 203.0 | 35.0 |
| TPS79928YZUR | DSBGA | YZU | 5 | 3000 | 182.0 | 182.0 | 20.0 |
| TPS79928YZUT | DSBGA | YZU | 5 | 250 | 210.0 | 185.0 | 35.0 |
| TPS79930DDCR | SOT-23-THIN | DDC | 5 | 3000 | 203.0 | 203.0 | 35.0 |
| TPS79930DDCR | SOT-23-THIN | DDC | 5 | 3000 | 183.0 | 183.0 | 20.0 |
| TPS79930DDCT | SOT-23-THIN | DDC | 5 | 250 | 203.0 | 203.0 | 35.0 |
| TPS79930YZUR | DSBGA | YZU | 5 | 3000 | 182.0 | 182.0 | 20.0 |
| TPS79930YZUT | DSBGA | YZU | 5 | 250 | 210.0 | 185.0 | 35.0 |
| TPS799315DDCR | SOT-23-THIN | DDC | 5 | 3000 | 203.0 | 203.0 | 35.0 |
| TPS799315DDCT | SOT-23-THIN | DDC | 5 | 250 | 203.0 | 203.0 | 35.0 |
| TPS799315YZUR | DSBGA | YZU | 5 | 3000 | 182.0 | 182.0 | 20.0 |
| TPS799315YZUT | DSBGA | YZU | 5 | 250 | 210.0 | 185.0 | 35.0 |
| TPS79932YZUR | DSBGA | YZU | 5 | 3000 | 182.0 | 182.0 | 20.0 |
| TPS79933DDCR | SOT-23-THIN | DDC | 5 | 3000 | 203.0 | 203.0 | 35.0 |
| TPS79933DDCR | SOT-23-THIN | DDC | 5 | 3000 | 183.0 | 183.0 | 20.0 |
| TPS79933DDCT | SOT-23-THIN | DDC | 5 | 250 | 183.0 | 183.0 | 20.0 |
| TPS79933DDCT | SOT-23-THIN | DDC | 5 | 250 | 203.0 | 203.0 | 35.0 |
| TPS79933DRVR | WSON | DRV | 6 | 3000 | 203.0 | 203.0 | 35.0 |
| TPS79933DRVT | WSON | DRV | 6 | 250 | 203.0 | 203.0 | 35.0 |
| TPS79933YZUR | DSBGA | YZU | 5 | 3000 | 182.0 | 182.0 | 20.0 |
| TPS79933YZUT | DSBGA | YZU | 5 | 250 | 182.0 | 182.0 | 20.0 |
| TPS79942DDCR | SOT-23-THIN | DDC | 5 | 3000 | 203.0 | 203.0 | 35.0 |
| TPS79942DDCT | SOT-23-THIN | DDC | 5 | 250 | 203.0 | 203.0 | 35.0 |
| TPS79945YZUR | DSBGA | YZU | 5 | 3000 | 182.0 | 182.0 | 20.0 |
| TPS79945YZUT | DSBGA | YZU | 5 | 250 | 210.0 | 185.0 | 35.0 |

GENERIC PACKAGE VIEW

DRV 6

WSON - 0.8 mm max height

PLASTIC SMALL OUTLINE - NO LEAD



Images above are just a representation of the package family, actual package may vary.
Refer to the product data sheet for package details.

4206925/F



4222173/B 04/2018

NOTES:

1. All linear dimensions are in millimeters. Any dimensions in parenthesis are for reference only. Dimensioning and tolerancing per ASME Y14.5M.
2. This drawing is subject to change without notice.
3. The package thermal pad must be soldered to the printed circuit board for thermal and mechanical performance.

EXAMPLE BOARD LAYOUT

DRV0006A

WSON - 0.8 mm max height

PLASTIC SMALL OUTLINE - NO LEAD



LAND PATTERN EXAMPLE
SCALE:25X



SOLDER MASK DETAILS

4222173/B 04/2018

NOTES: (continued)

4. This package is designed to be soldered to a thermal pad on the board. For more information, see Texas Instruments literature number SLUA271 (www.ti.com/lit/sluea271).
5. Vias are optional depending on application, refer to device data sheet. If some or all are implemented, recommended via locations are shown.

EXAMPLE STENCIL DESIGN

DRV0006A

WSON - 0.8 mm max height

PLASTIC SMALL OUTLINE - NO LEAD



SOLDER PASTE EXAMPLE
BASED ON 0.125 mm THICK STENCIL

EXPOSED PAD #7
88% PRINTED SOLDER COVERAGE BY AREA UNDER PACKAGE
SCALE:30X

4222173/B 04/2018

NOTES: (continued)

6. Laser cutting apertures with trapezoidal walls and rounded corners may offer better paste release. IPC-7525 may have alternate design recommendations.

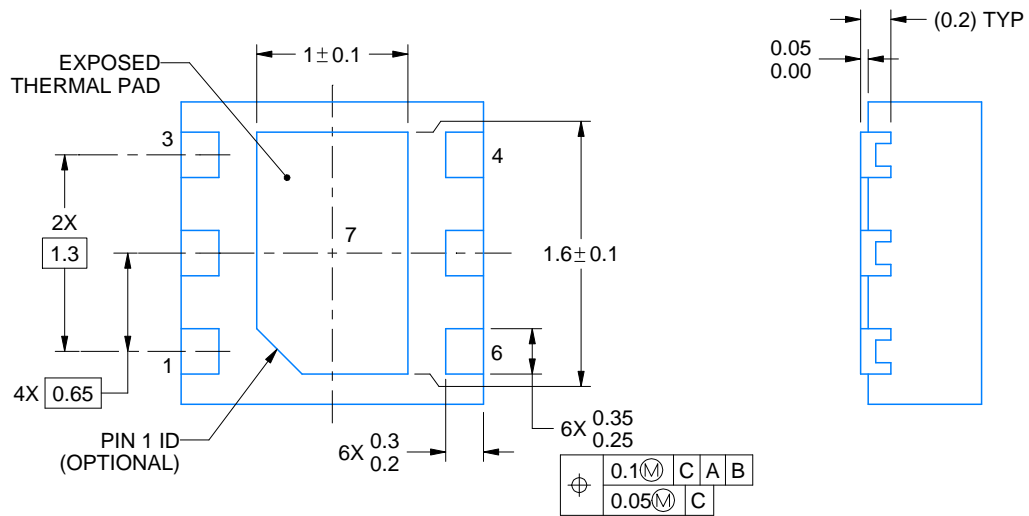
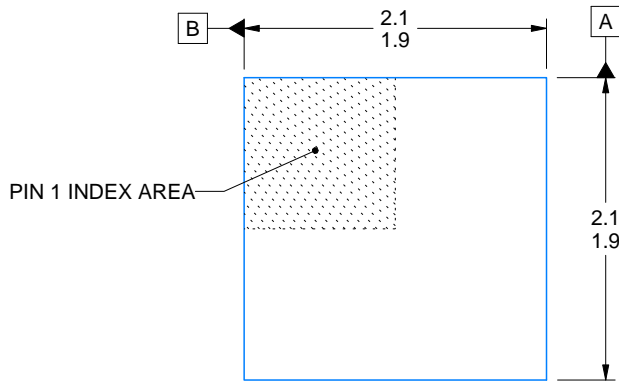
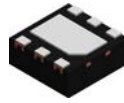

4225563/A 12/2019

NOTES:

1. All linear dimensions are in millimeters. Any dimensions in parenthesis are for reference only. Dimensioning and tolerancing per ASME Y14.5M.
2. This drawing is subject to change without notice.
3. The package thermal pad must be soldered to the printed circuit board for thermal and mechanical performance.

EXAMPLE BOARD LAYOUT

DRV0006D

WSON - 0.8 mm max height

PLASTIC SMALL OUTLINE - NO LEAD



LAND PATTERN EXAMPLE
EXPOSED METAL SHOWN
SCALE:25X



SOLDER MASK DETAILS

4225563/A 12/2019

NOTES: (continued)

4. This package is designed to be soldered to a thermal pad on the board. For more information, see Texas Instruments literature number SLUA271 (www.ti.com/lit/sluea271).
5. Vias are optional depending on application, refer to device data sheet. If some or all are implemented, recommended via locations are shown.

EXAMPLE STENCIL DESIGN

DRV0006D

WSON - 0.8 mm max height

PLASTIC SMALL OUTLINE - NO LEAD



SOLDER PASTE EXAMPLE
BASED ON 0.125 mm THICK STENCIL

EXPOSED PAD #7
88% PRINTED SOLDER COVERAGE BY AREA UNDER PACKAGE
SCALE:30X

4225563/A 12/2019

NOTES: (continued)

6. Laser cutting apertures with trapezoidal walls and rounded corners may offer better paste release. IPC-7525 may have alternate design recommendations.

DDC (R-PDSO-G5)

PLASTIC SMALL-OUTLINE

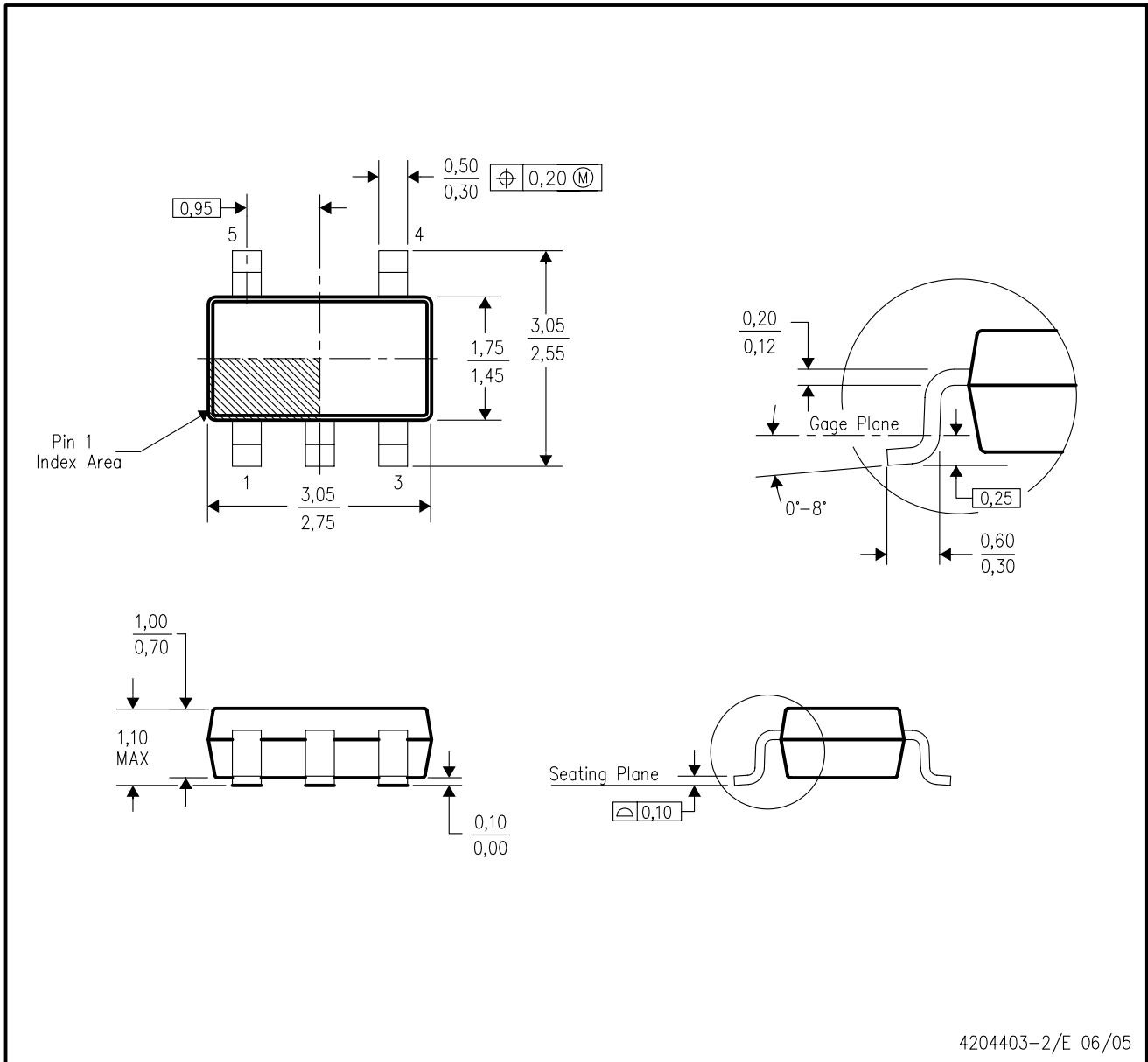

- NOTES:
- A. All linear dimensions are in millimeters.
 - B. This drawing is subject to change without notice.
 - C. Body dimensions do not include mold flash or protrusion.
 - D. Falls within JEDEC MO-193 variation AB (5 pin).

DDC (R-PDSO-G5)

PLASTIC SMALL OUTLINE

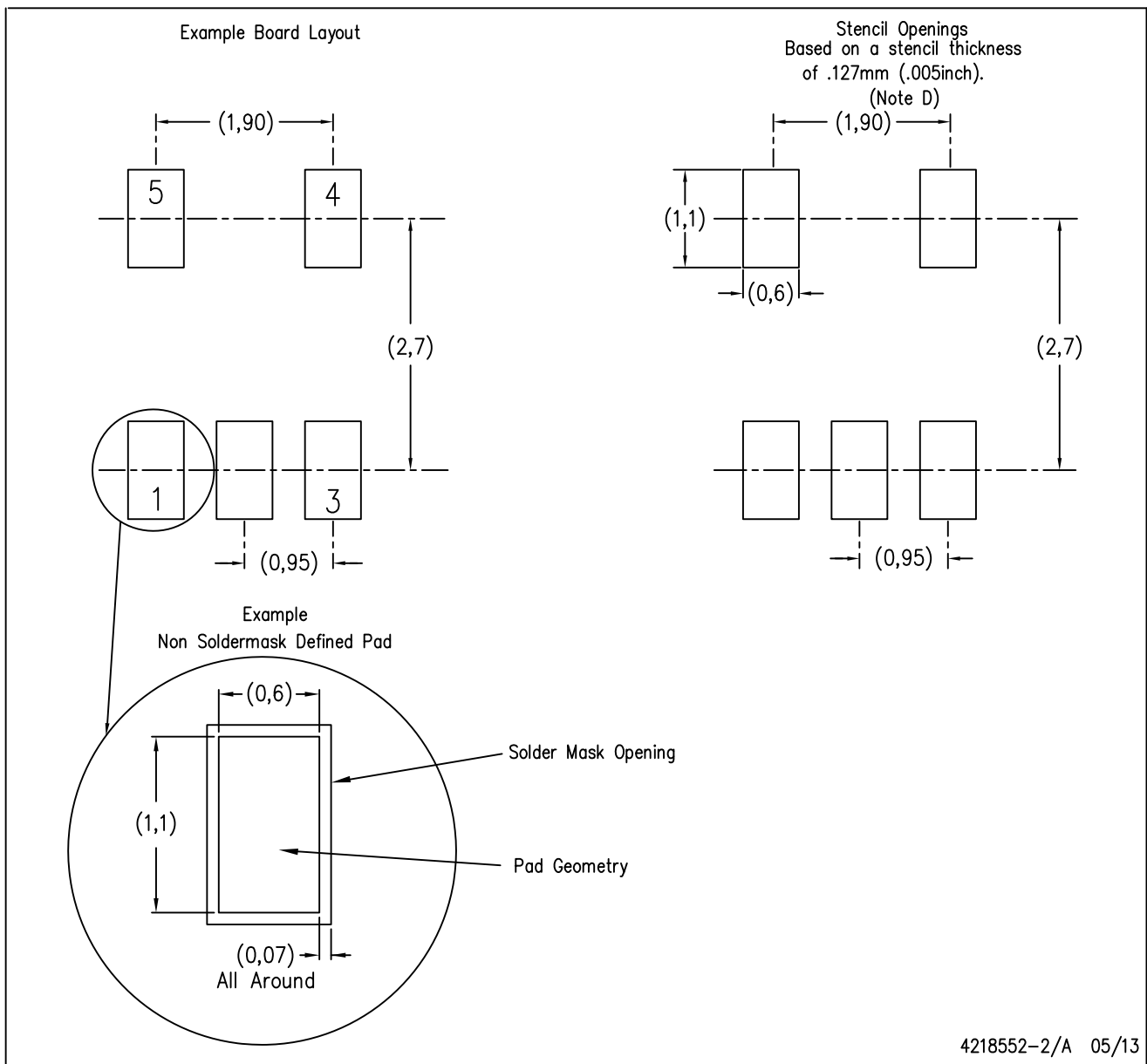

- NOTES:
- All linear dimensions are in millimeters.
 - This drawing is subject to change without notice.
 - Publication IPC-7351 is recommended for alternate designs.
 - Laser cutting apertures with trapezoidal walls and also rounding corners will offer better paste release. Customers should contact their board assembly site for stencil design recommendations. Example stencil design based on a 50% volumetric metal load solder paste. Refer to IPC-7525 for other stencil recommendations.

YZU0005

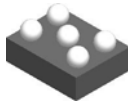

PACKAGE OUTLINE

DSBGA - 0.625 mm max height

DIE SIZE BALL GRID ARRAY

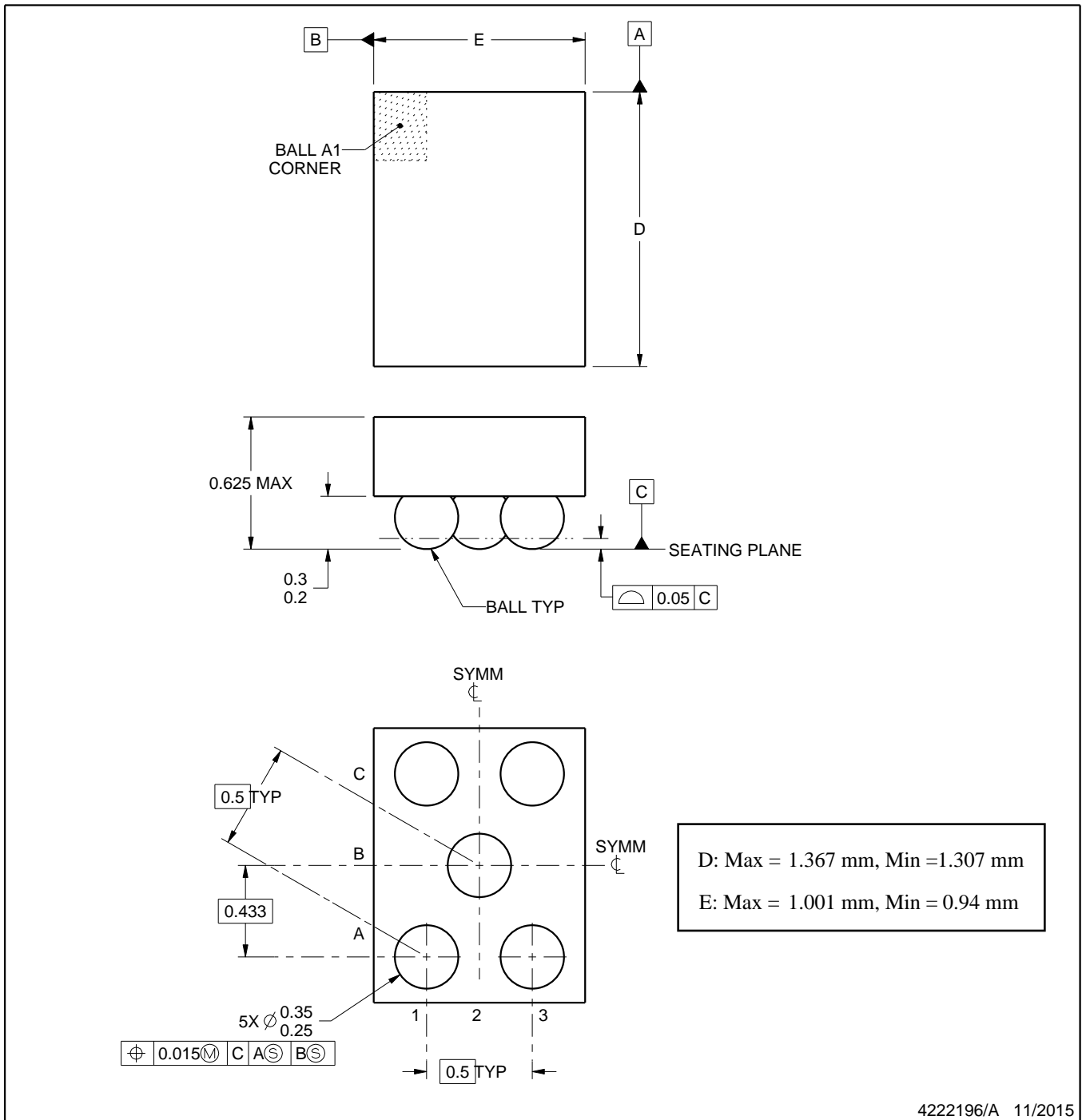

NOTES:

1. All linear dimensions are in millimeters. Any dimensions in parenthesis are for reference only. Dimensioning and tolerancing per ASME Y14.5M.
2. This drawing is subject to change without notice.

EXAMPLE BOARD LAYOUT

YZU0005

DSBGA - 0.625 mm max height

DIE SIZE BALL GRID ARRAY

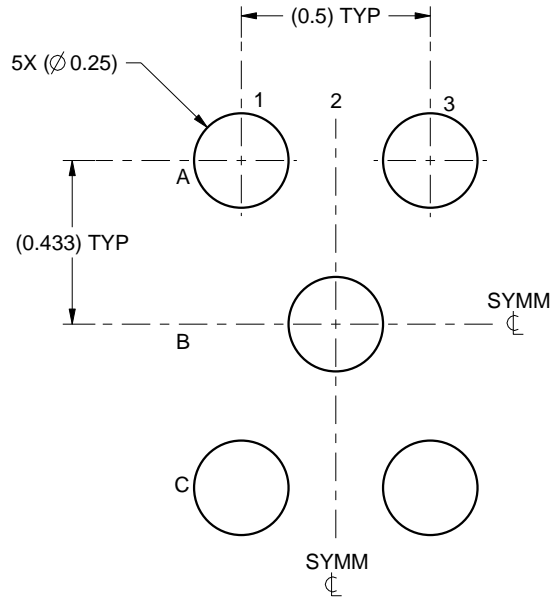

LAND PATTERN EXAMPLE
SCALE:50X

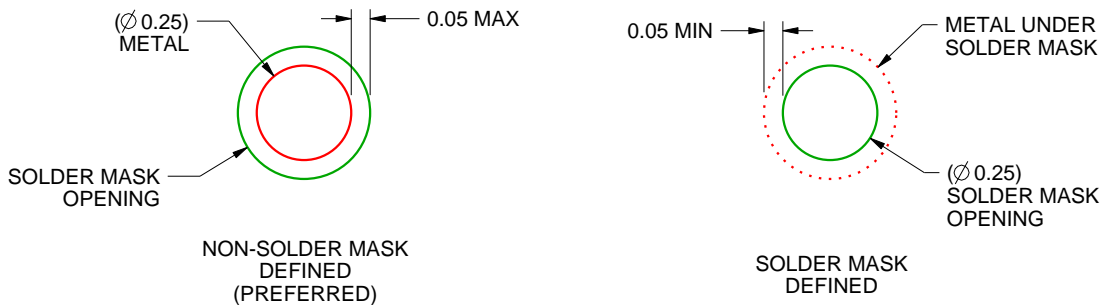

SOLDER MASK DETAILS
NOT TO SCALE

4222196/A 11/2015

NOTES: (continued)

3. Final dimensions may vary due to manufacturing tolerance considerations and also routing constraints. Refer to Texas Instruments Literature No. SNVA009 (www.ti.com/lit/snva009).

EXAMPLE STENCIL DESIGN

YZU0005

DSBGA - 0.625 mm max height

DIE SIZE BALL GRID ARRAY

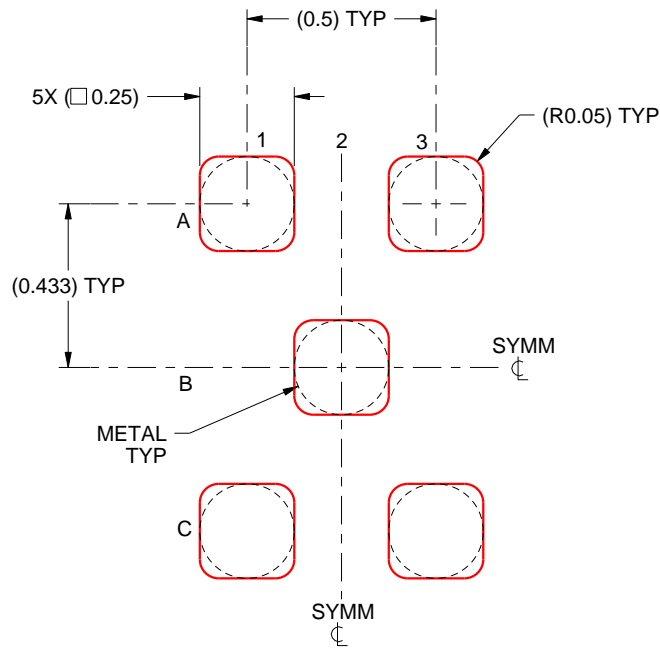

SOLDER PASTE EXAMPLE
BASED ON 0.1 mm THICK STENCIL
SCALE:50X

4222196/A 11/2015

NOTES: (continued)

4. Laser cutting apertures with trapezoidal walls and rounded corners may offer better paste release.

IMPORTANT NOTICE AND DISCLAIMER

TI PROVIDES TECHNICAL AND RELIABILITY DATA (INCLUDING DATASHEETS), DESIGN RESOURCES (INCLUDING REFERENCE DESIGNS), APPLICATION OR OTHER DESIGN ADVICE, WEB TOOLS, SAFETY INFORMATION, AND OTHER RESOURCES "AS IS" AND WITH ALL FAULTS, AND DISCLAIMS ALL WARRANTIES, EXPRESS AND IMPLIED, INCLUDING WITHOUT LIMITATION ANY IMPLIED WARRANTIES OF MERCHANTABILITY, FITNESS FOR A PARTICULAR PURPOSE OR NON-INFRINGEMENT OF THIRD PARTY INTELLECTUAL PROPERTY RIGHTS.

These resources are intended for skilled developers designing with TI products. You are solely responsible for (1) selecting the appropriate TI products for your application, (2) designing, validating and testing your application, and (3) ensuring your application meets applicable standards, and any other safety, security, or other requirements. These resources are subject to change without notice. TI grants you permission to use these resources only for development of an application that uses the TI products described in the resource. Other reproduction and display of these resources is prohibited. No license is granted to any other TI intellectual property right or to any third party intellectual property right. TI disclaims responsibility for, and you will fully indemnify TI and its representatives against, any claims, damages, costs, losses, and liabilities arising out of your use of these resources.

TI's products are provided subject to TI's Terms of Sale (www.ti.com/legal/termsofsale.html) or other applicable terms available either on ti.com or provided in conjunction with such TI products. TI's provision of these resources does not expand or otherwise alter TI's applicable warranties or warranty disclaimers for TI products.

Mailing Address: Texas Instruments, Post Office Box 655303, Dallas, Texas 75265
Copyright © 2020, Texas Instruments Incorporated