

# Type FCP Surface Mount Film Capacitors

## Stable Stacked Metallized Film (PPS) Chips for Reflow Soldering

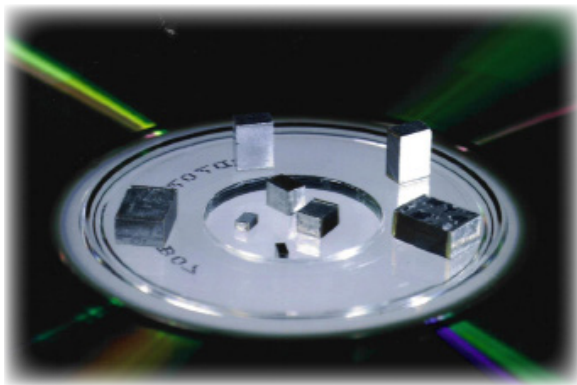

The Type FCP's combination of high capacitance density and excellent high frequency response makes it a great choice for wireless and instrumentation applications.

Type FCP stacked metallized polyphenylene sulfide (PPS) film capacitors offer high capacitance per unit volume, stable capacitance and DF over a wide temperature range, and excellent high frequency performance. Type FCP capacitors conform to standard EIA 0603, 0805, 1206, 1210, 1913 & 2416 surface mount case sizes and are packaged on tape and reel.

### Highlights

- Stacked metallized polyphenylene sulfide (PPS) film.
- High operating temperature to +125 °C
- High capacitance per unit volume
- Excellent high frequency performance
- Typical  $\Delta C$  from -55 °C to 105 °C  $\leq \pm 1.5\%$
- Stable cap and DF over wide temperature range

### Specifications

Capacitance Range	100 pF to 0.22 $\mu$ F (1kHz at $\leq 5$ Vrms)
Capacitance Tolerance	$\pm 5\%$ (J) Standard, $\pm 2\%$ (G) Optional
Rated Voltage	16 Vdc and 50 Vdc
Dissipation Factor (Tan $\delta$ )	0.6% Max. (1 kHz at $\leq 5$ Vrms)
Operating Temperature Range	-55 °C to +125 °C (See Voltage derating chart for 0.12 - 0.22 $\mu$ F above 105 °C)
Dielectric Strength	150% of rated Vdc for 60 s
Insulation Resistance	3000 M $\Omega$ Min. at 20 °C, after 60 s (16 Vdc rated, test 10 Vdc; 50 Vdc rated, test 50 Vdc)
Construction	Stacked metallized polyphenylene sulfide (PPS) film. Terminations are lead free with a Sn-Ag-Cu solder finish.
Life Test	Capacitors subjected to 1000 hours of maximum rated temperature and 125% of the rated voltage will not have any significant visual damage, the capacitance will be within $\pm 2\%$ of the initial measured value, DF will be a maximum of 0.66%, and IR will be a minimum of 1000 Megohms.
Resistance to Soldering Heat	Capacitors subjected to a maximum of 260 °C reflow soldering process will not have any significant visual damage, the dielectric strength will be as specified, the capacitance will be within $\pm 3\%$ of the initial measured value, DF will be a maximum of .66%, and IR will be a minimum of 1000 Megohms.
Moisture Resistance	Capacitors subjected to 1000 h at 40 °C and 90% to 95% RH and rated voltage will not have any significant visual damage, will withstand 1.3 times the rated voltage for one minute, the capacitance will be within $\pm 2\%$ of the initial measured value, DF will be a maximum of 0.9%, and IR will be a minimum of 1000 Megohms.

[RoHS Compliant](#)

# Type FCP Surface Mount Film Capacitors

## Stable Stacked Metallized Film (PPS) Chips for Reflow Soldering

### Ratings

Capacitance			16 Vdc		50 Vdc	
( $\mu$ F)	(nF)	(pF)	Catalog Part Number	Case Code	Catalog Part Number	Case Code
.00010	.10	100	FCP0603C101J-K1	0603	FCP0805H101J-J1	0805
.00012	.12	120	FCP0603C121J-K1		FCP0805H121J-J1	
.00015	.15	150	FCP0603C151J-K1		FCP0805H151J-J1	
.00018	.18	180	FCP0603C181J-K1		FCP0805H181J-J1	
.00022	.22	220	FCP0603C221J-K1		FCP0805H221J-J1	
.00027	.27	270	FCP0603C271J-K1		FCP0805H271J-J1	
.00033	.33	330	FCP0603C331J-K1		FCP0805H331J-J1	
.00039	.39	390	FCP0603C391J-K1		FCP0805H391J-J1	
.00047	.47	470	FCP0603C471J-K1		FCP0805H471J-J1	
.00056	.56	560	FCP0603C561J-K1		FCP0805H561J-J1	
.00068	.68	680	FCP0603C681J-K1		FCP0805H681J-J1	
.00082	.82	820	FCP0603C821J-K1		FCP0805H821J-J1	
.0010	1.00	1000	FCP0603C102J-K1		FCP0805H102J-J1	
.0012	1.20	1200	FCP0603C122J-K1		FCP0805H122J-J1	
.0015	1.50	1500	FCP0603C152J-K1		FCP0805H152J-J1	
.0018	1.80	1800	FCP0603C182J-K1	FCP0805H182J-J1		
.0022	2.20	2200	FCP0603C222J-K1	FCP0805H222J-J1		
.0027	2.70	2700	FCP0603C272J-K1	FCP0805H272J-J1		
.0033	3.30	3300	FCP0805C332J-J1	805	FCP1206H332J-H1	1206
.0039	3.90	3900	FCP0805C392J-J1		FCP1206H392J-H1	
.0047	4.70	4700	FCP0805C472J-J1		FCP1206H472J-H1	
.0056	5.60	5600	FCP0805C562J-J1		FCP1206H562J-H1	
.0068	6.80	6800	FCP0805C682J-J1		FCP1206H682J-H1	
.0082	8.20	8200	FCP0805C822J-J2		FCP1206H822J-H2	
.010	10	10000	FCP0805C103J-J2	FCP1206H103J-H2		
.012	12	12000	FCP1206C123J-H1	1206	FCP1210H123J-G1	1210
.015	15	15000	FCP1206C153J-H1		FCP1210H153J-G1	
.018	18	18000	FCP1206C183J-H1		FCP1210H183J-G2	
.022	22	22000	FCP1206C223J-H1		FCP1210H223J-G2	
.027	27	27000	FCP1206C273J-H2		FCP1210H273J-G2	
.033	33	33000	FCP1206C333J-H2		FCP1210H333J-G3	
.039	39	39000	FCP1206C393J-H3		FCP1210H393J-G3	
.047	47	47000	FCP1206C473J-H3	FCP1913H473J-E1	1913	
.056	56	56000	FCP1210C563J-G2	FCP1913H563J-E1		
.068	68	68000	FCP1210C683J-G2	FCP1913H683J-E1		
.082	82	82000	FCP1210C823J-G3	FCP1913H823J-E2		
.100	100	100000	FCP1210C104J-G3	FCP1913H104J-E2		
.12	120	120000		FCP2416H124J-D1	2416	
.15	150	150000		FCP2416H154J-D1		
.18	180	180000		FCP2416H184J-D3		
.22	220	220000		FCP2416H224J-D4		

# Type FCP Surface Mount Film Capacitors

## Stable Stacked Metallized Film (PPS) Chips for Reflow Soldering

### Typical Temperature Characteristics

### Typical Frequency Characteristics

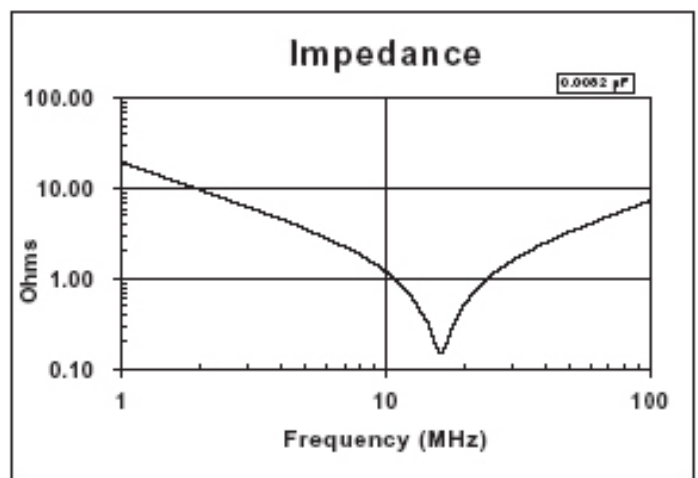
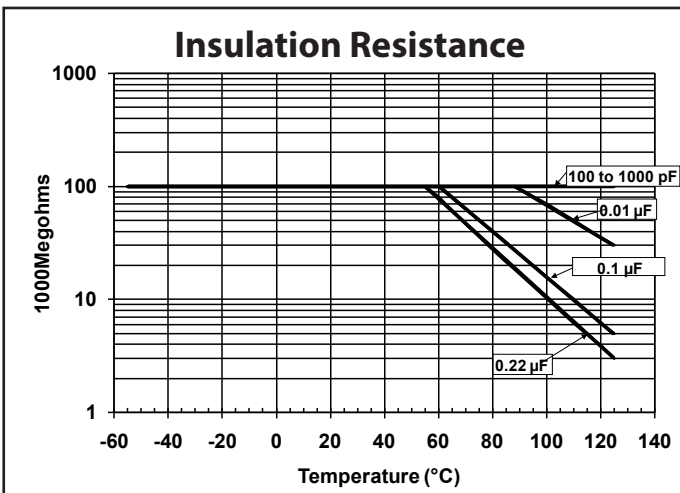
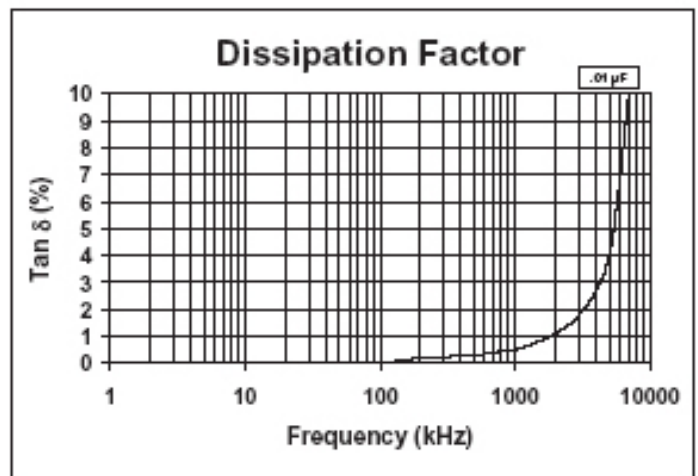
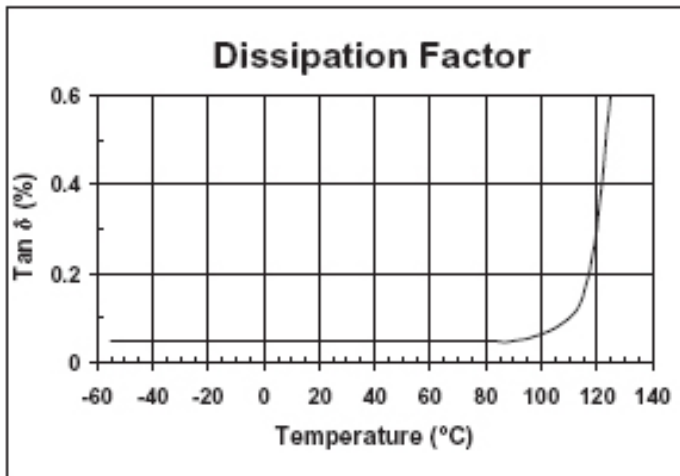
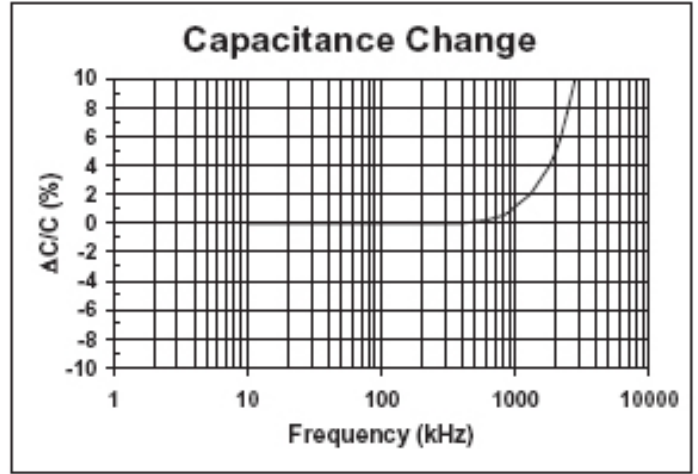
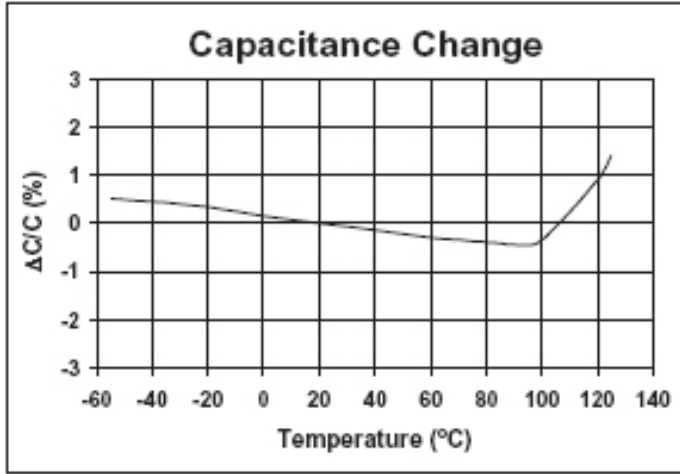

# Type FCP Surface Mount Film Capacitors

## Stable Stacked Metallized Film (PPS) Chips for Reflow Soldering

### Outline Dimensions

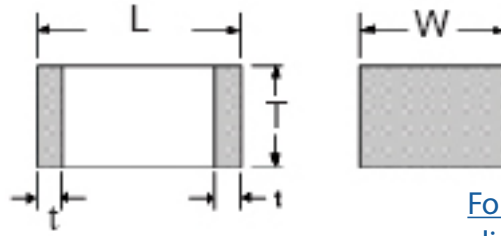

For packaging codes/dimensions please [click here for Application Guide](#)

Case Code	Outline Dimensions (in.)				Case Code (metric)	Outline Dimensions (mm)				Packaging Code
	L ±0.008	W	T ±0.008	t		L ±0.2	W	T ±0.2	t	
0603	0.063	0.032±0.006	0.028±0.006	0.014±0.008	1608	1.6	0.80±0.15	0.70±0.15	0.35±0.2	K1
0805	0.079	0.049±0.008	0.035	0.018±0.010	2012	2.0	1.25±0.2	0.9	0.45±0.25	J1
			0.043					1.1		
1206	0.126	0.063±0.008	0.035	0.026±0.012	3216	3.2	1.6±0.2	0.9	0.65±0.3	H1
			0.043					1.1		
			0.059					1.5		
1210	0.126	0.098±0.008	0.043	0.026±0.012	3225	3.2	2.5±0.2	1.1	0.65±0.3	G1
			0.059					1.5		
			0.083					2.1		
1913	0.189	0.130±0.012	0.059	0.031±0.012	4833	4.8	3.3±0.3	1.5	0.80±0.3	E1
			0.083					2.1		
2416	0.236	0.161±0.012	0.075	0.031±0.012	6041	6.0	4.1±0.3	1.9	0.80±0.3	D1
			0.098					2.5		
			0.110					2.8		

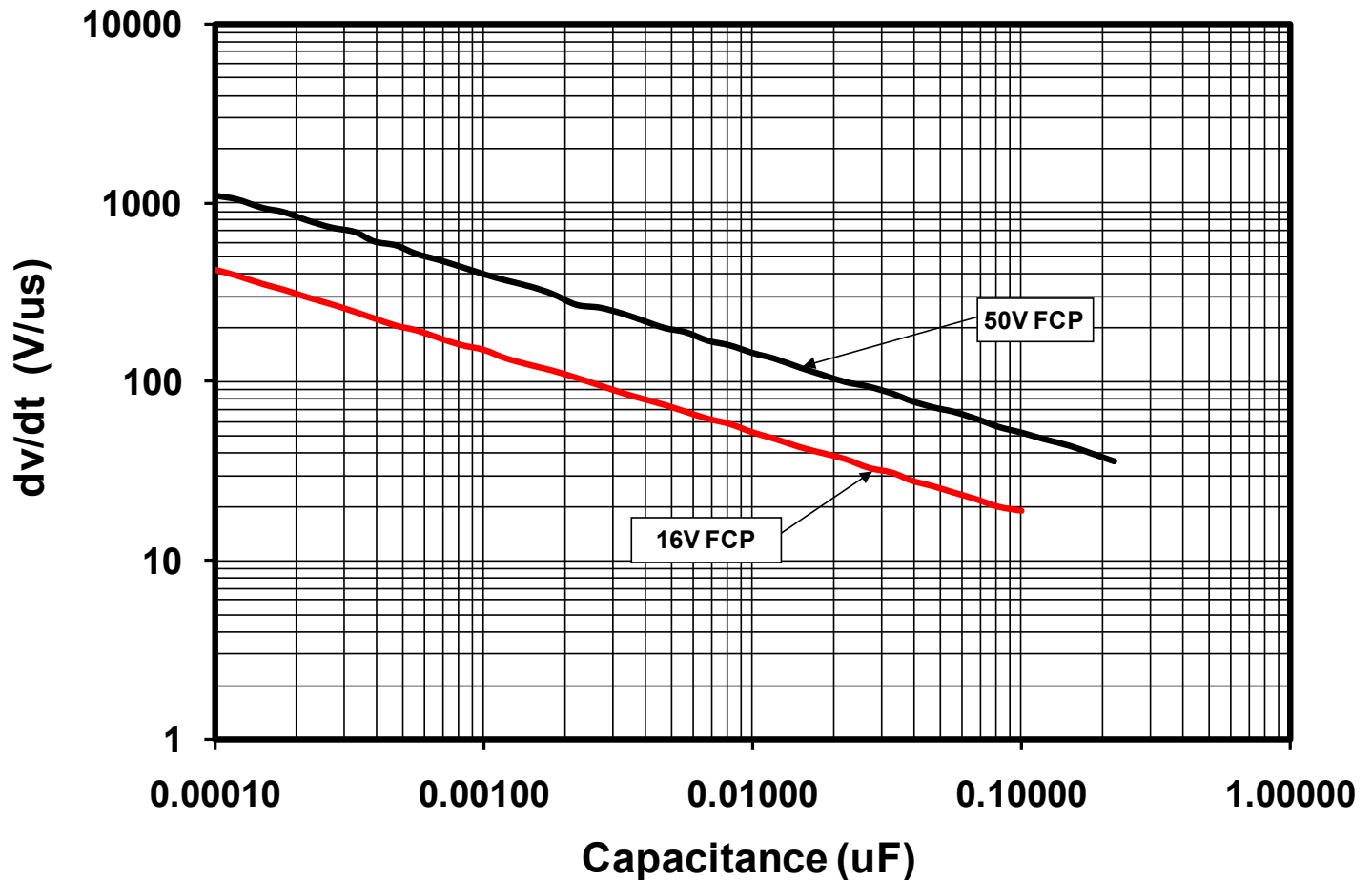

# Type FCP Surface Mount Film Capacitors

## Stable Stacked Metallized Film (PPS) Chips for Reflow Soldering

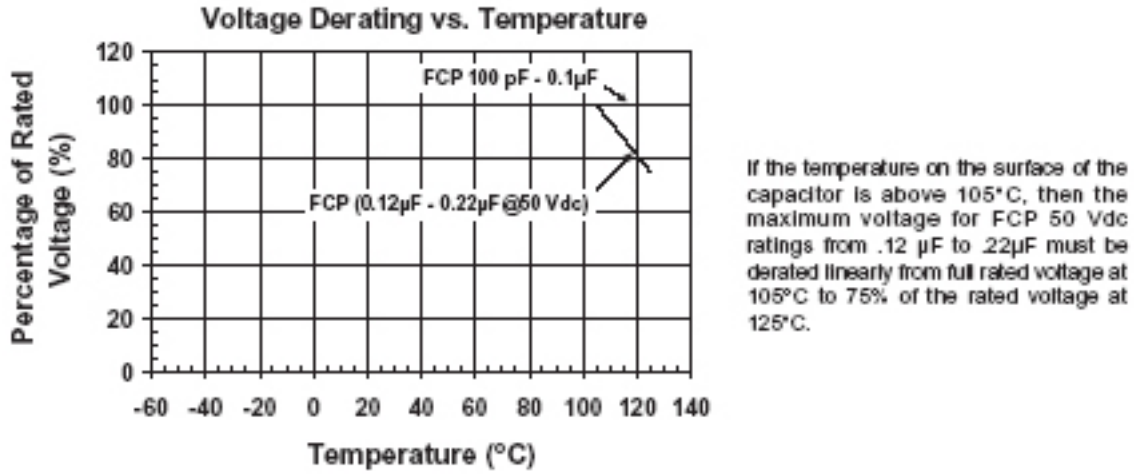

### FCP 0805 50 Vdc Rating Vrms and Arms vs. Frequency

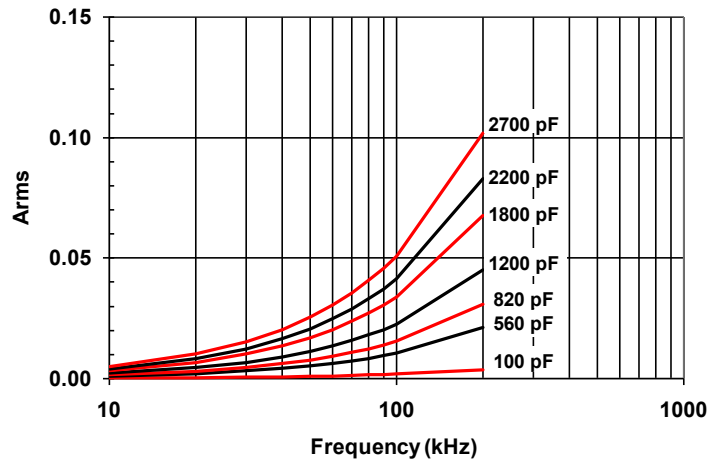
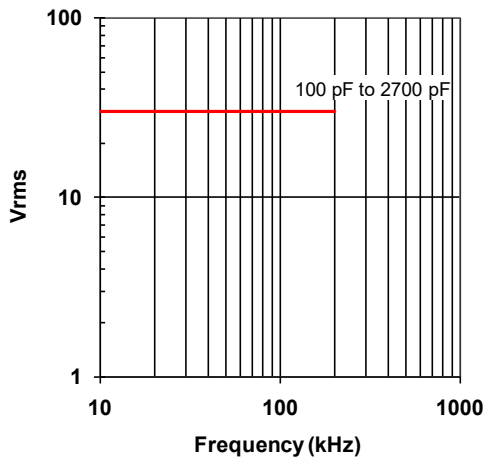

### FCP 1206 50 Vdc Rating Vrms and Arms vs. Frequency

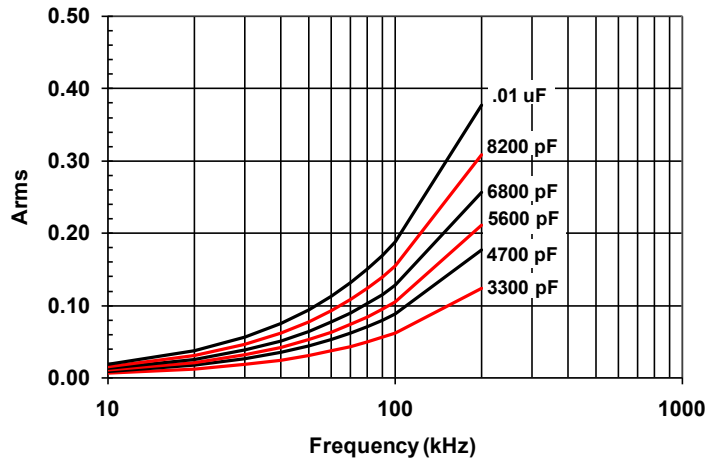
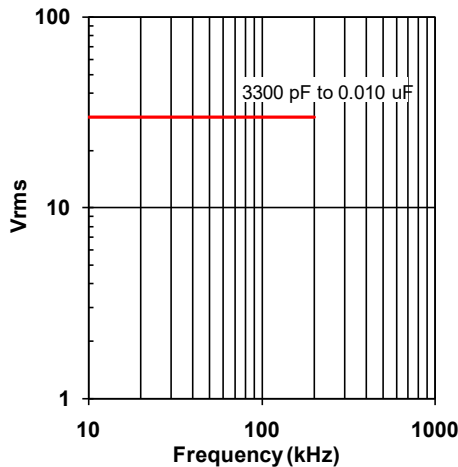

# Type FCP Surface Mount Film Capacitors

## Stable Stacked Metallized Film (PPS) Chips for Reflow Soldering

### FCP 1210 50 Vdc Rating Vrms and Arms vs. Frequency

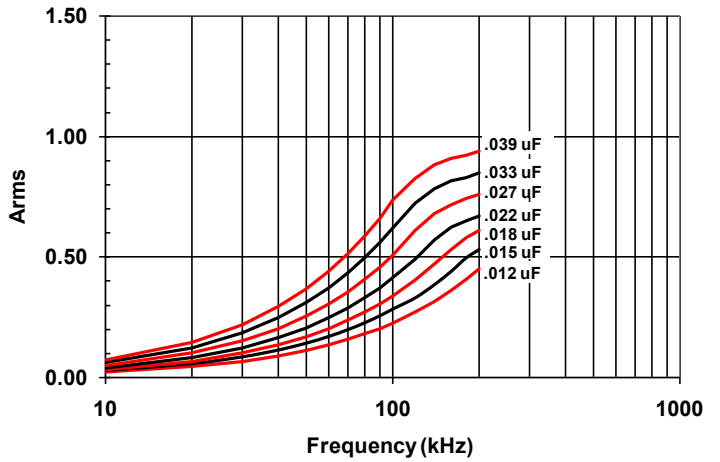
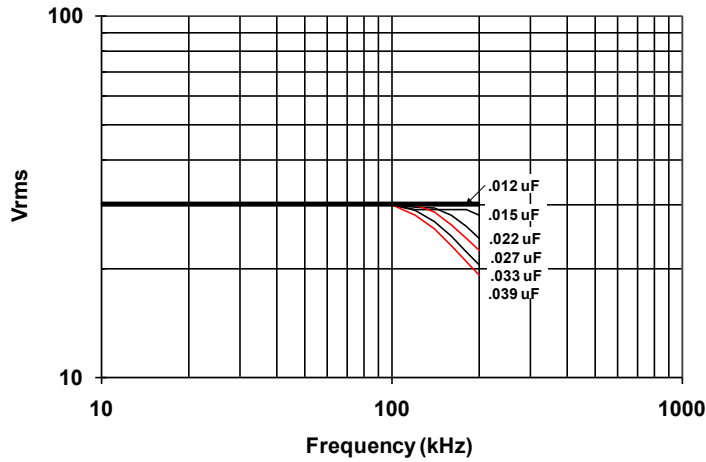

### FCP 1913 & 2416 50 Vdc Rating Vrms and Arms vs. Frequency

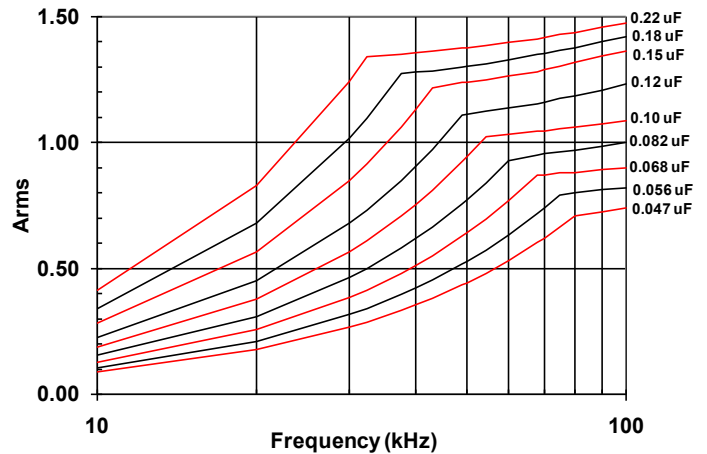
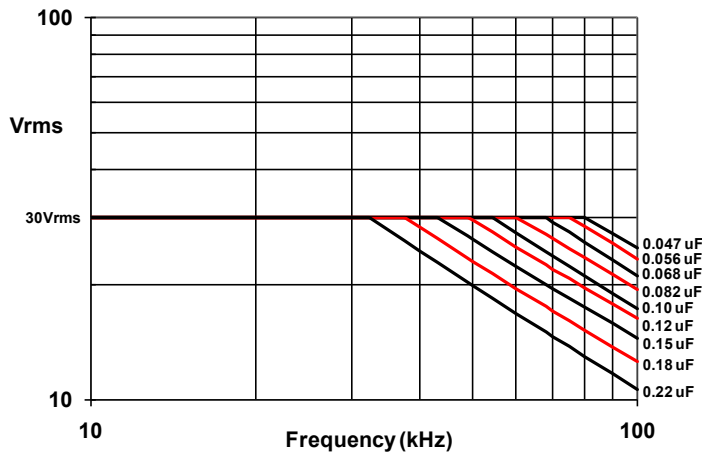

### Maximum AC Voltage FCP 16Vdc Series

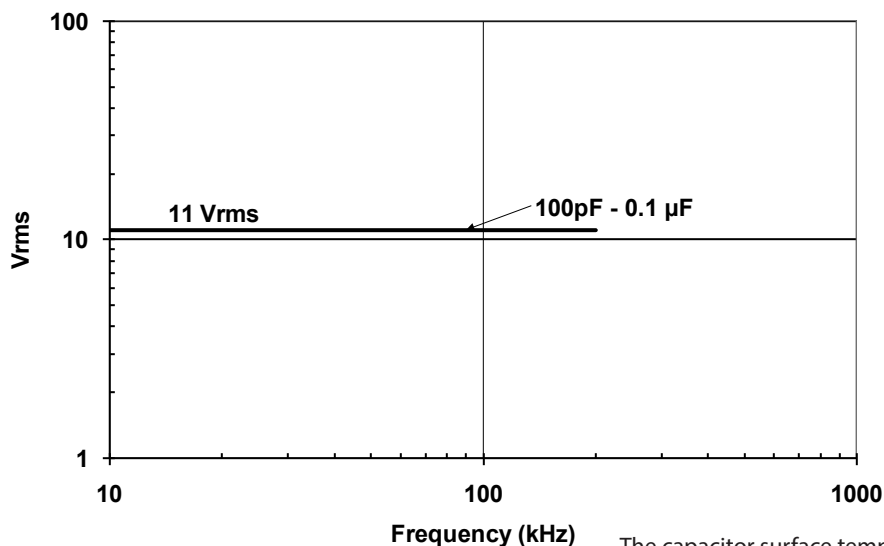

The capacitor surface temperature should not exceed 125 °C.

# Type FCP Surface Mount Film Capacitors

## Stable Stacked Metallized Film (PPS) Chips for Reflow Soldering

### Typical Applications

#### Filtering Capacitor for xDSL:

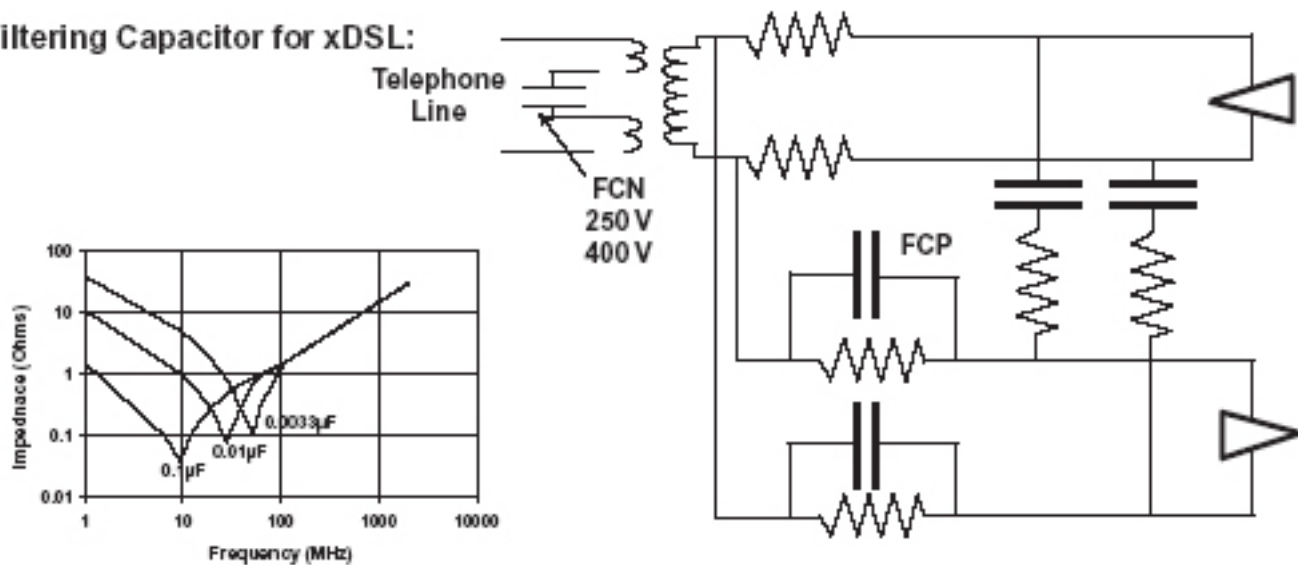

#### Capacitance Change vs. Bias Voltage

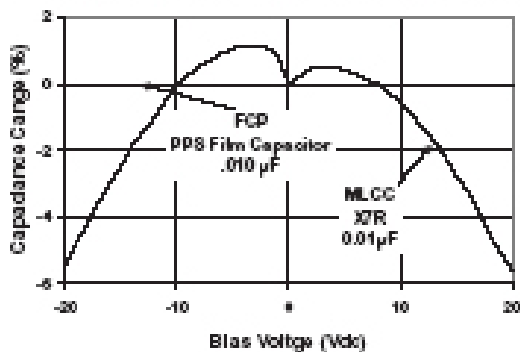

#### Capacitance Change vs. Temperature

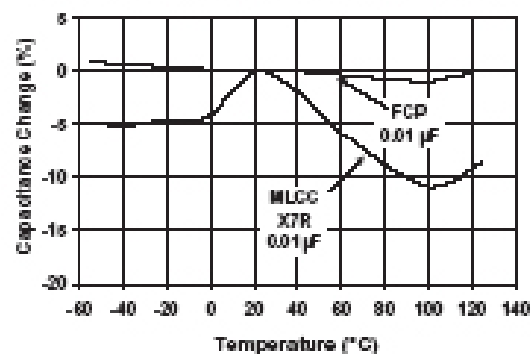

The capacitance of SMT film chips is much more stable with applied voltage and with changes in temperature than multilayer ceramic capacitors. Add in the low ESR characteristics of film chips and the final result is improved performance in filter circuit applications.

#### PLL Circuit: Cellular phone, Blue Tooth, Data Communication Cards

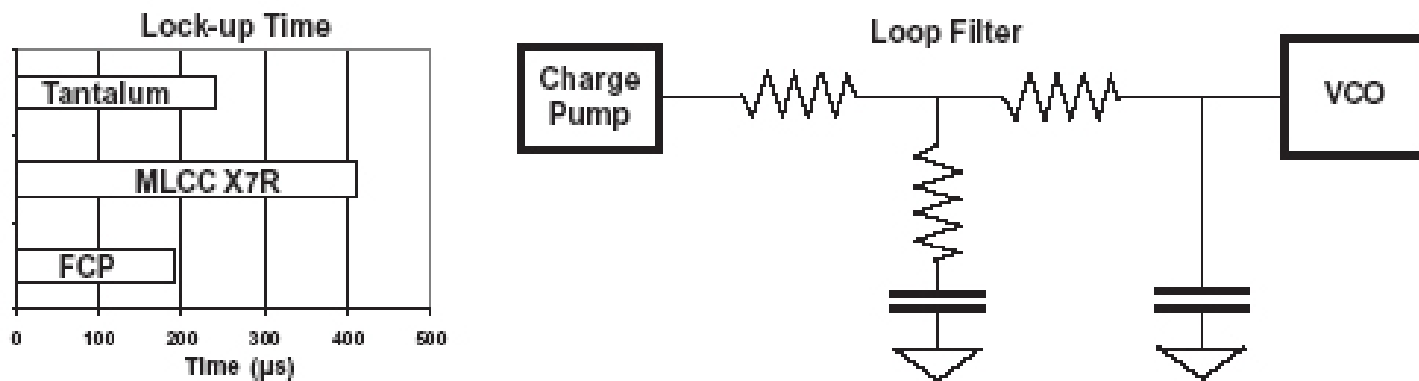

In PLL circuit applications, FCP SMT film capacitor advantages are tight tolerance on the capacitance value, stable capacitance with temperature, faster lock-up times, and no noise due to piezoelectric effects.

**Notice and Disclaimer:** All product drawings, descriptions, specifications, statements, information and data (collectively, the "Information") in this datasheet or other publication are subject to change. The customer is responsible for checking, confirming and verifying the extent to which the Information contained in this datasheet or other publication is applicable to an order at the time the order is placed. All Information given herein is believed to be accurate and reliable, but it is presented without any guarantee, warranty, representation or responsibility of any kind, expressed or implied. Statements of suitability for certain applications are based on the knowledge that the Cornell Dubilier company providing such statements ("Cornell Dubilier") has of operating conditions that such Cornell Dubilier company regards as typical for such applications, but are not intended to constitute any guarantee, warranty or representation regarding any such matter – and Cornell Dubilier specifically and expressly disclaims any guarantee, warranty or representation concerning the suitability for a specific customer application, use, storage, transportation, or operating environment. The Information is intended for use only by customers who have the requisite experience and capability to determine the correct products for their application. Any technical advice inferred from this Information or otherwise provided by Cornell Dubilier with reference to the use of any Cornell Dubilier products is given gratis (unless otherwise specified by Cornell Dubilier), and Cornell Dubilier assumes no obligation or liability for the advice given or results obtained. Although Cornell Dubilier strives to apply the most stringent quality and safety standards regarding the design and manufacturing of its products, in light of the current state of the art, isolated component failures may still occur. Accordingly, customer applications which require a high degree of reliability or safety should employ suitable designs or other safeguards (such as installation of protective circuitry or redundancies or other appropriate protective measures) in order to ensure that the failure of an electrical component does not result in a risk of personal injury or property damage. Although all product-related warnings, cautions and notes must be observed, the customer should not assume that all safety measures are indicated in such warnings, cautions and notes, or that other safety measures may not be required.