



Features

- Output voltage $5\text{ V} \pm 2\%$
- Very low current consumption
- Power-on and undervoltage reset
- Reset low down to $V_Q = 1\text{ V}$
- Very low-drop voltage
- Short-circuit-proof
- Reverse polarity proof
- Suitable for use in automotive electronics
- ESD protection $> 4\text{ kV}$
- Green Product (RoHS compliant) version of TLE 4275
- AEC qualified

Functional Description

The TLE 4275 is a monolithic integrated low-drop voltage regulator in a 5-pin TO-package. An input voltage up to 45 V is regulated to $V_{Q,nom} = 5.0\text{ V}$. The IC is able to drive loads up to 450 mA and is short-circuit proof. At overtemperature the TLE 4275 is turned off by the incorporated temperature protection. A reset signal is generated for an output voltage $V_{Q,rt}$ of typ. 4.65 V. The delay time can be programmed by the external delay capacitor.

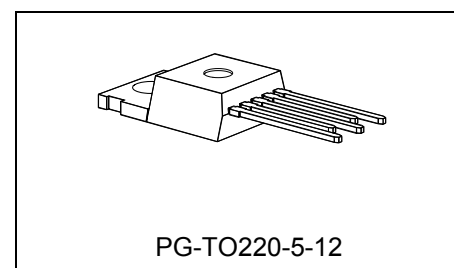
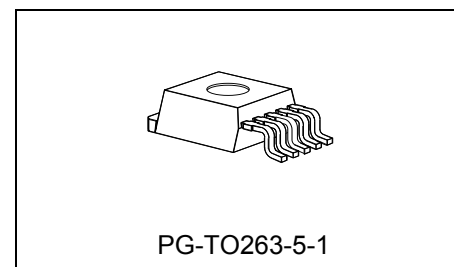
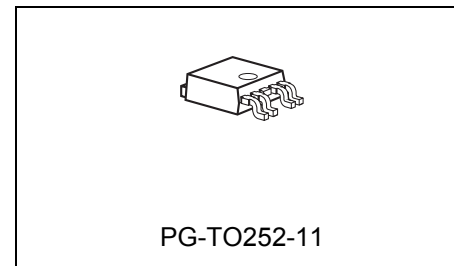
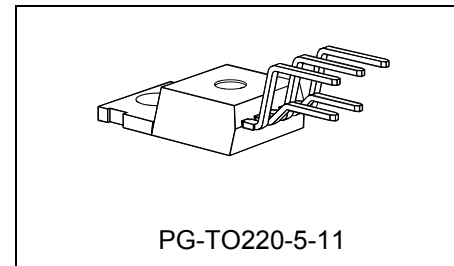

Type	Package
TLE 4275	PG-TO220-5-11 (RoHS compliant)
TLE 4275 D	PG-TO252-5-11 (RoHS compliant)
TLE 4275 G	PG-TO263-5-1 (RoHS compliant)
TLE 4275 S	PG-TO220-5-12 (RoHS compliant)

Dimensioning Information on External Components

The input capacitor C_I is necessary for compensation of line influences. Using a resistor of approx. 1Ω in series with C_I , the oscillating of input inductivity and input capacitance can be damped. The output capacitor C_Q is necessary for the stability of the regulation circuit. Stability is guaranteed at values $C_Q \geq 22 \mu\text{F}$ and an ESR of $\leq 5 \Omega$ within the operating temperature range.

Circuit Description

The control amplifier compares a reference voltage to a voltage that is proportional to the output voltage and drives the base of the series transistor via a buffer. Saturation control as a function of the load current prevents any oversaturation of the power element. The IC also incorporates a number of internal circuits for protection against:

- Overload
- Overtemperature
- Reverse polarity

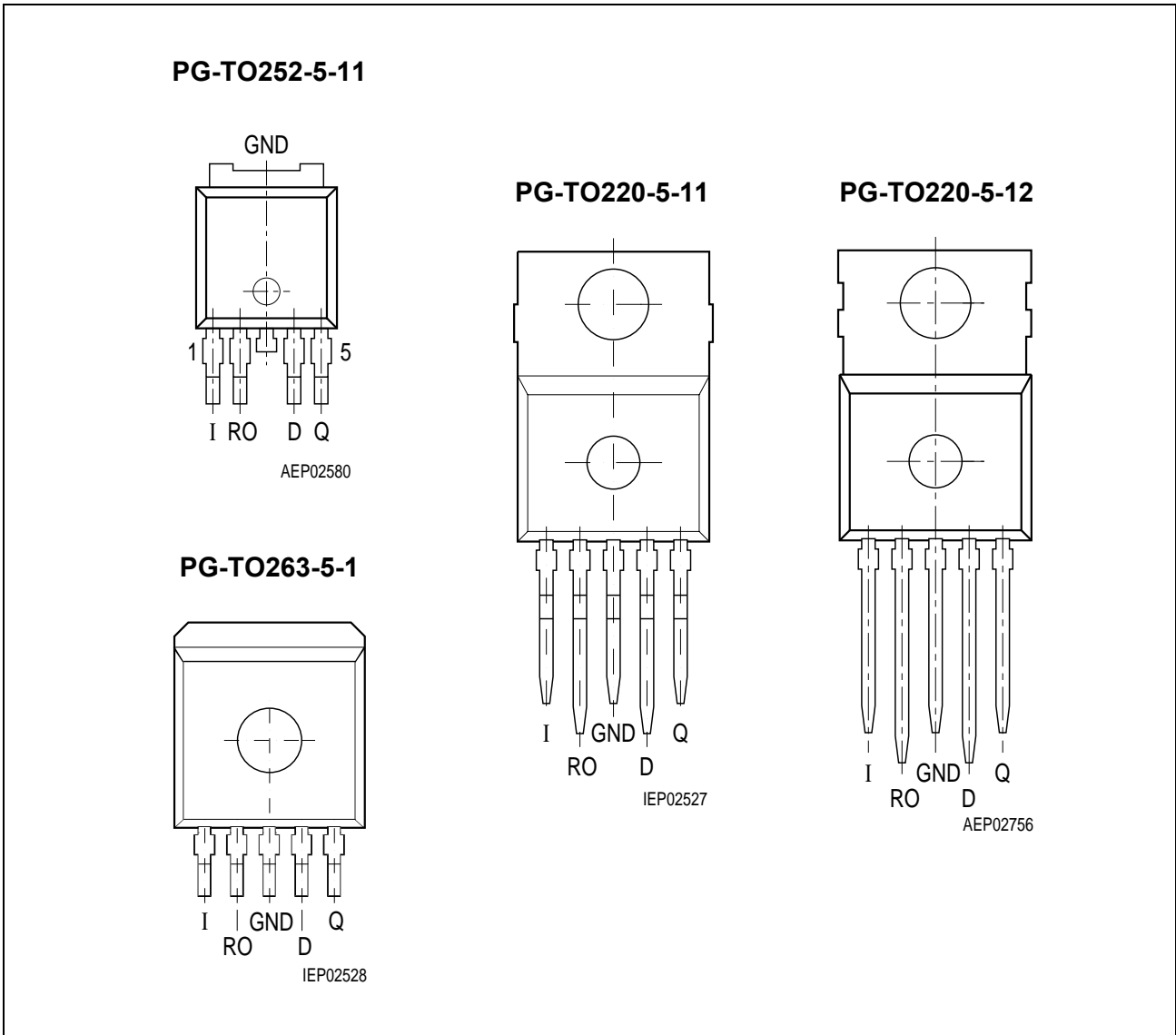

Figure 1 Pin Configuration (top view)

Table 1 Pin Definitions and Functions

Pin No.	Symbol	Function
1	I	Input ; block to ground directly at the IC by a ceramic capacitor.
2	RO	Reset Output ; open collector output
3	GND	Ground ; Pin 3 internally connected to heatsink
4	D	Reset Delay ; connect capacitor to GND for setting delay time
5	Q	Output ; block to ground with a $\geq 22 \mu\text{F}$ capacitor, ESR < 5 Ω at 10 kHz.

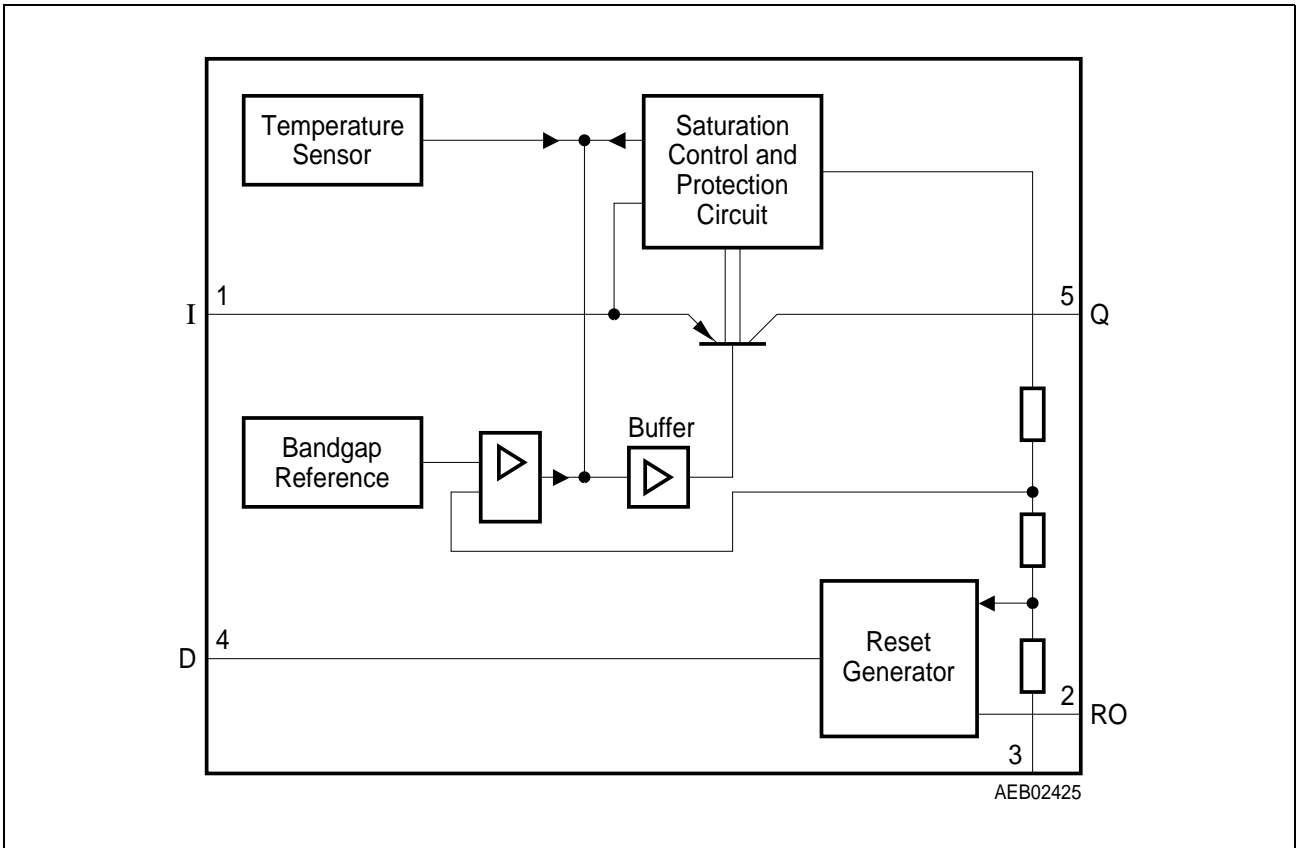

Figure 2 Block Diagram

Table 2 Absolute Maximum Ratings

Parameter	Symbol	Limit Values		Unit	Test Condition
		Min.	Max.		
Input					
Voltage	V_I	-42	45	V	–
Current	I_I	–	–	–	Internally limited
Output					
Voltage	V_Q	-1.0	16	V	–
Current	I_Q	–	–	–	Internally limited
Reset Output					
Voltage	V_{RO}	-0.3	25	V	–
Current	I_{RO}	– 5	5	mA	–
Reset Delay					
Voltage	V_D	-0.3	7	V	–
Current	I_D	-2	2	mA	–
Temperature					
Junction temperature	T_j	-40	150	°C	–
Storage temperature	T_{stg}	-50	150	°C	–

Note: Maximum ratings are absolute ratings; exceeding any one of these values may cause irreversible damage to the integrated circuit.

Table 3 Operating Range

Parameter	Symbol	Limit Values		Unit	Remarks
		Min.	Max.		
Input voltage	V_I	5.5	42	V	–
Junction temperature	T_j	-40	150	°C	–
Thermal Resistance					
Junction case	R_{thjc}	–	4	K/W	–
Junction ambient	R_{thj-a}	–	53	K/W	TO263 ¹⁾
Junction ambient	R_{thj-a}	–	78	K/W	TO252 ¹⁾
Junction ambient	R_{thj-a}	–	65	K/W	TO220

1) Worst case, regarding peak temperature; zero airflow; mounted on a PCB FR4, 80 × 80 × 1.5 mm³, heat sink area 300 mm²

Table 4 Characteristics
 $V_I = 13.5 \text{ V}; -40 \text{ }^\circ\text{C} < T_j < 150 \text{ }^\circ\text{C}$ (unless otherwise specified)

Parameter	Symbol	Limit Values			Unit	Measuring Condition
		Min.	Typ.	Max.		
Output						
Output voltage	V_Q	4.9	5.0	5.1	V	$5 \text{ mA} < I_Q < 400 \text{ mA}$ $6 \text{ V} < V_I < 28 \text{ V}$
Output voltage	V_Q	4.9	5.0	5.1	V	$5 \text{ mA} < I_Q < 200 \text{ mA}$ $6 \text{ V} < V_I < 40 \text{ V}$
Output current limitation ¹⁾	I_Q	450	700	–	mA	–
Current consumption; $I_q = I_I - I_Q$	I_q	–	150	200	μA	$I_Q = 1 \text{ mA};$ $T_j = 25 \text{ }^\circ\text{C}$
Current consumption; $I_q = I_I - I_Q$	I_q	–	150	220	μA	$I_Q = 1 \text{ mA};$ $T_j \leq 85 \text{ }^\circ\text{C}$
Current consumption; $I_q = I_I - I_Q$	I_q	–	5	10	mA	$I_Q = 250 \text{ mA}$
Current consumption; $I_q = I_I - I_Q$	I_q	–	12	22	mA	$I_Q = 400 \text{ mA}$
Drop voltage ¹⁾	V_{dr}	–	250	500	mV	$I_Q = 300 \text{ mA};$ $V_{\text{dr}} = V_I - V_Q$
Load regulation	ΔV_Q	–	15	30	mV	$I_Q = 5 \text{ mA to } 400 \text{ mA}$
Line regulation	ΔV_Q	-15	5	15	mV	$\Delta V_I = 8 \text{ V to } 32 \text{ V}$ $I_Q = 5 \text{ mA}$
Power supply ripple rejection	$PSRR$	–	60	–	dB	$f_r = 100 \text{ Hz};$ $V_r = 0.5 \text{ Vpp}$
Temperature output voltage drift	dV_Q/dT	–	0.5	–	mV/K	–

Table 4 Characteristics (cont'd)
 $V_I = 13.5 \text{ V}; -40 \text{ }^\circ\text{C} < T_j < 150 \text{ }^\circ\text{C}$ (unless otherwise specified)

Parameter	Symbol	Limit Values			Unit	Measuring Condition
		Min.	Typ.	Max.		
Reset Timing D and Output RO						
Reset switching threshold	$V_{Q,rt}$	4.5	4.65	4.8	V	–
Reset output low voltage	V_{ROL}	–	0.2	0.4	V	$R_{ext} \geq 5 \text{ k}\Omega;$ $V_Q > 1 \text{ V}$
Reset output leakage current	I_{ROH}	–	0	10	μA	$V_{ROH} = 5 \text{ V}$
Reset charging current	$I_{D,c}$	3.0	5.5	9.0	μA	$V_D = 1 \text{ V}$
Upper timing threshold	V_{DU}	1.5	1.8	2.2	V	–
Lower timing threshold	V_{DRL}	0.2	0.4	0.7	V	–
Reset delay time	t_{rd}	10	16	22	ms	$C_D = 47 \text{ nF}$
Reset reaction time	t_{rr}	–	0.5	2	μs	$C_D = 47 \text{ nF}$

 1) Measured when the output voltage V_Q has dropped 100 mV from the nominal value obtained at $V_I = 13.5 \text{ V}$.

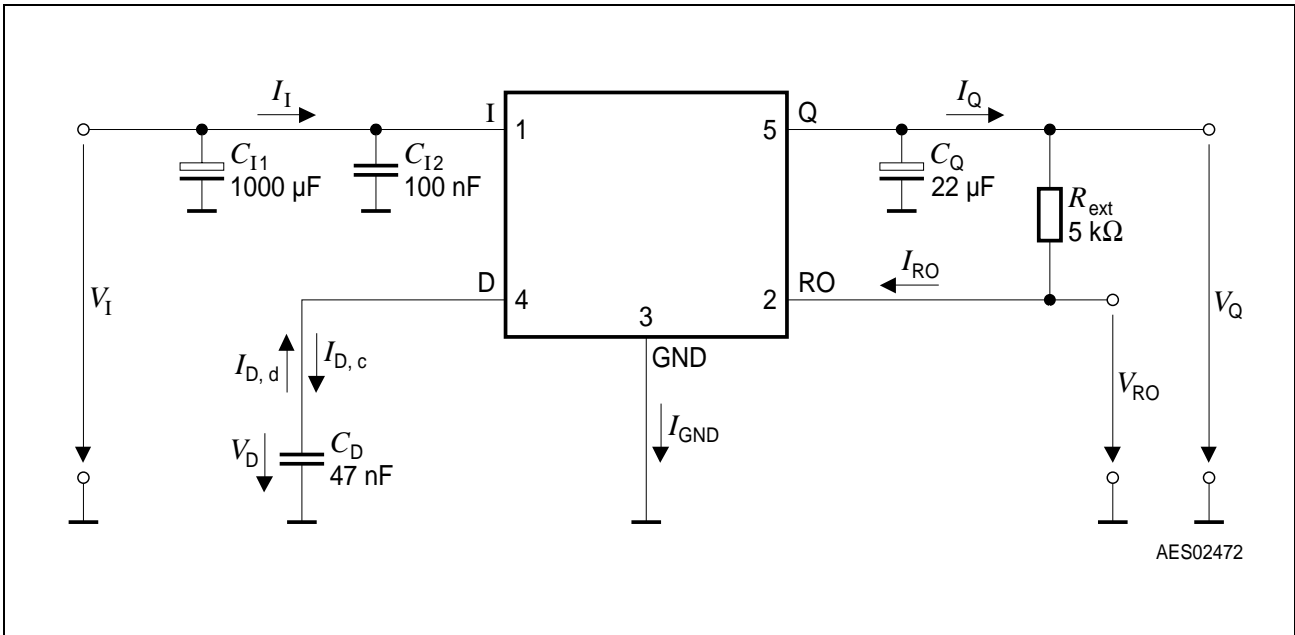

Figure 3 Test Circuit

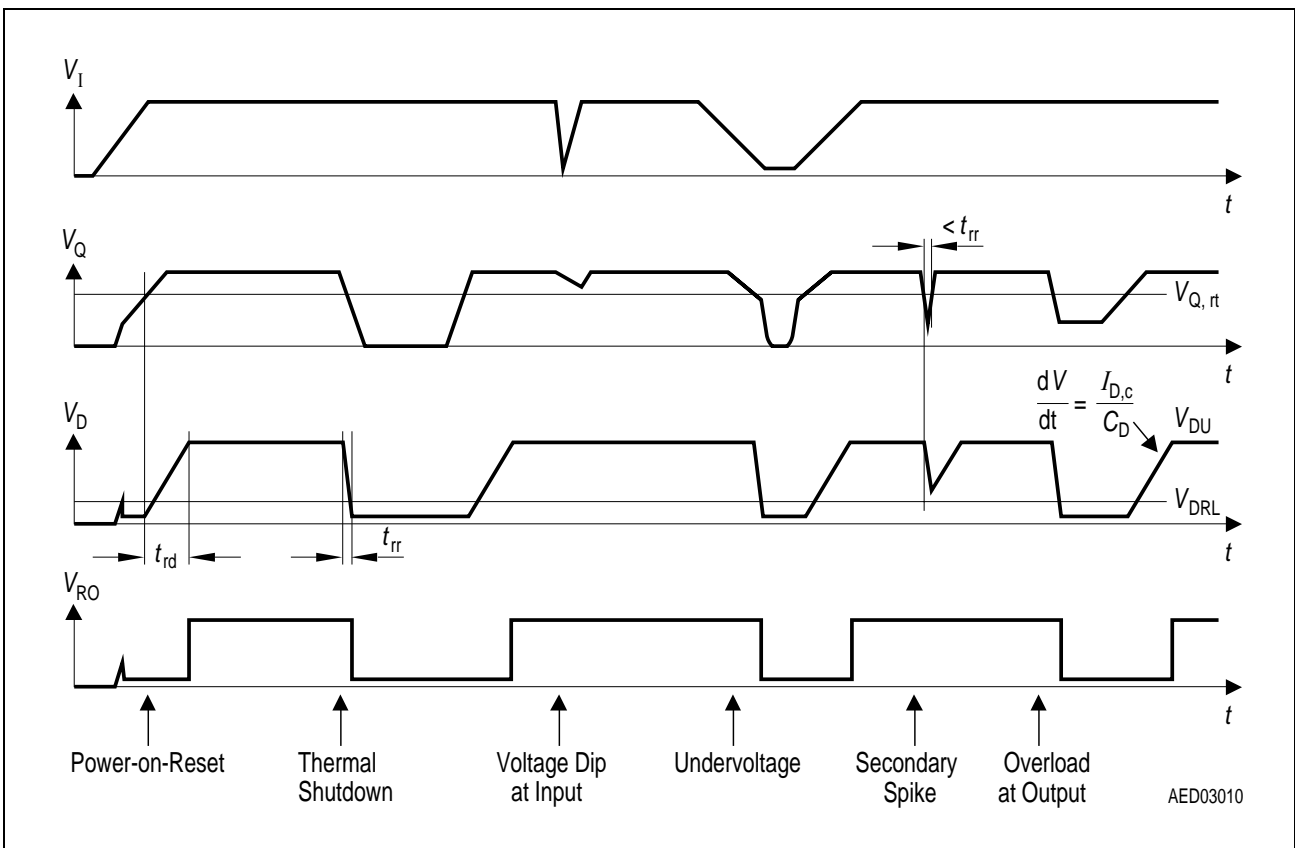
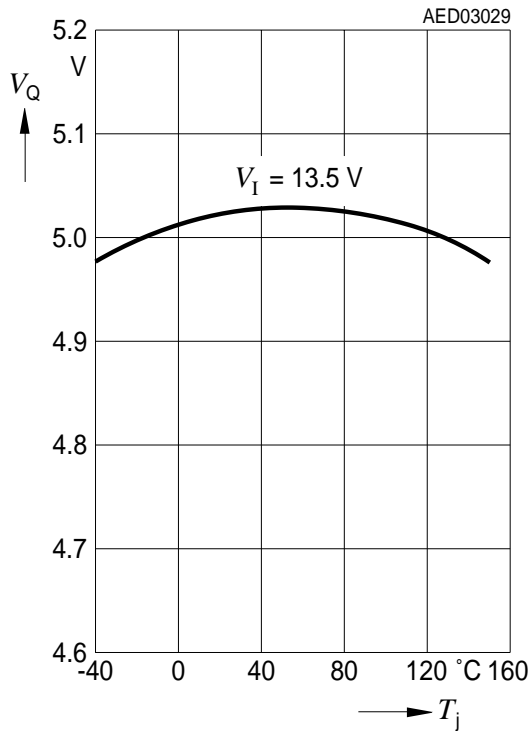
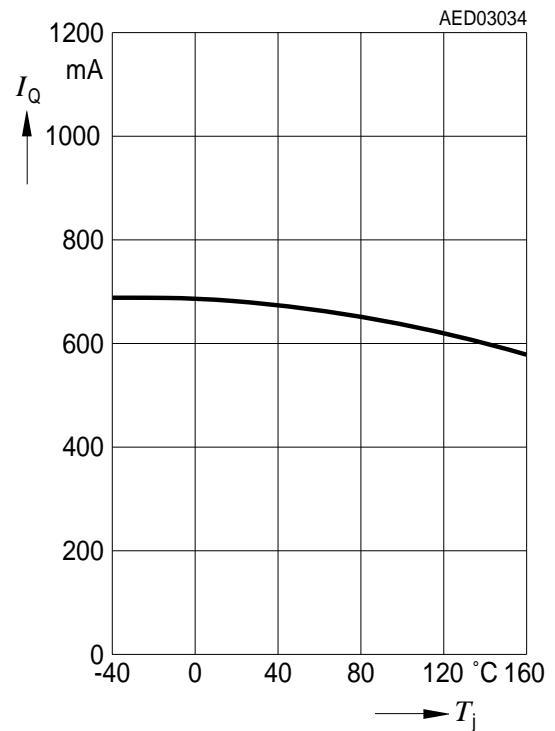

Figure 4 Reset Timing

Output Voltage V_Q versus Temperature T_j



Output Current I_Q versus Temperature T_j



Output Voltage V_Q versus Temperature T_j

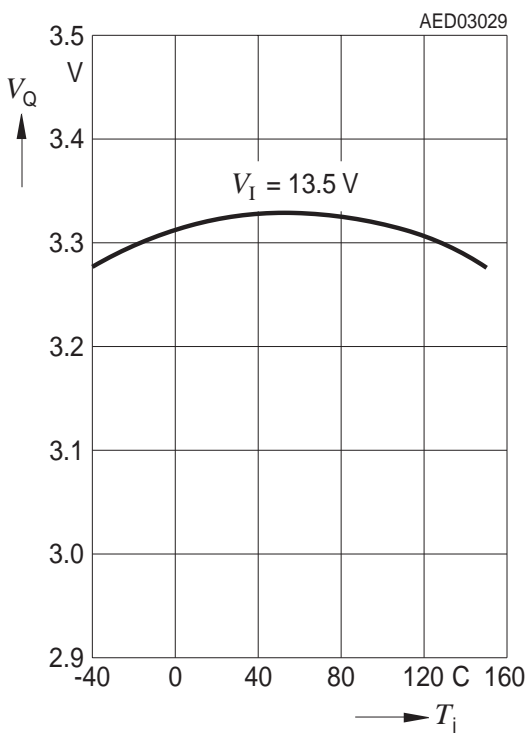

Output Voltage V_Q versus Input Voltage V_I

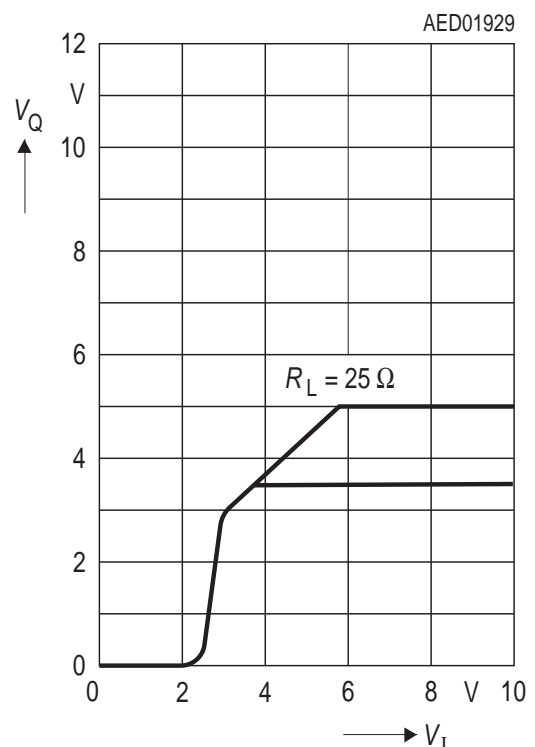

Output Current I_Q versus Input Voltage V_I

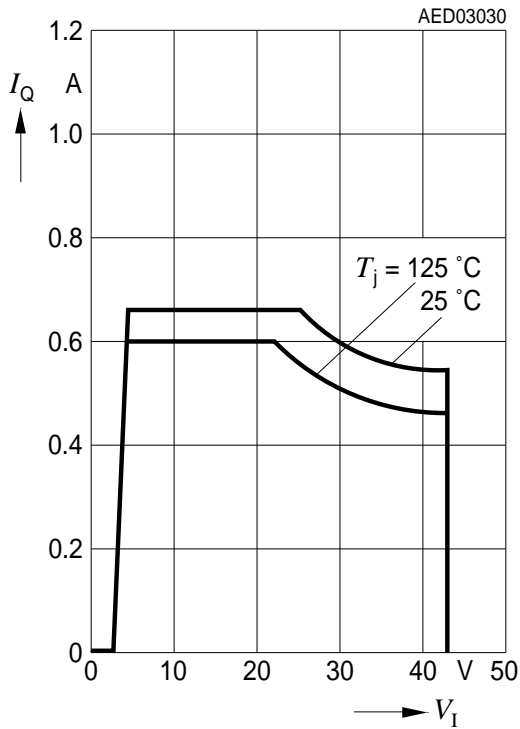

Current Consumption I_q versus Output Current I_Q

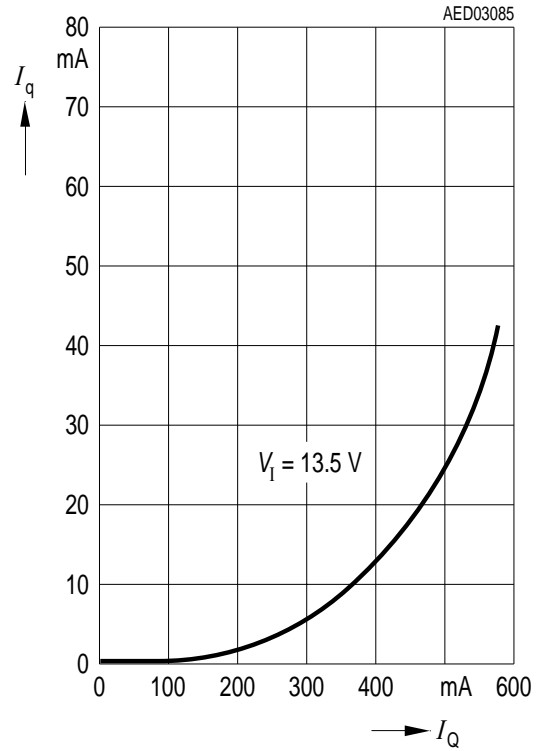

Current Consumption I_q versus Output Current I_Q

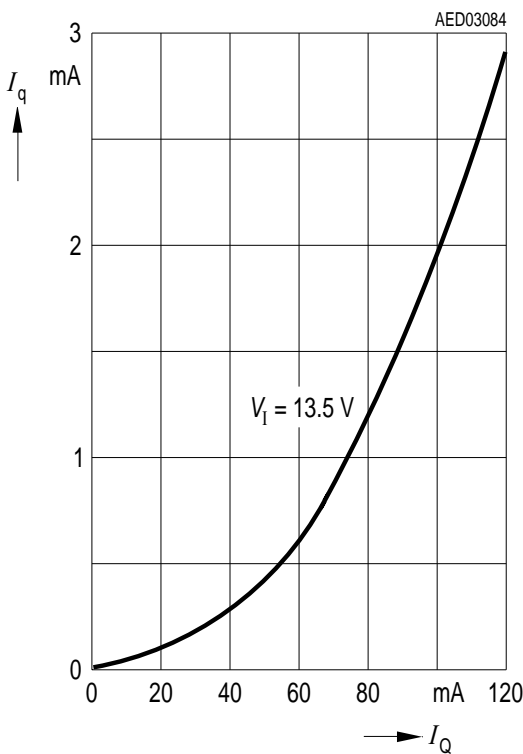

Drop Voltage V_{dr} versus Output Current I_Q

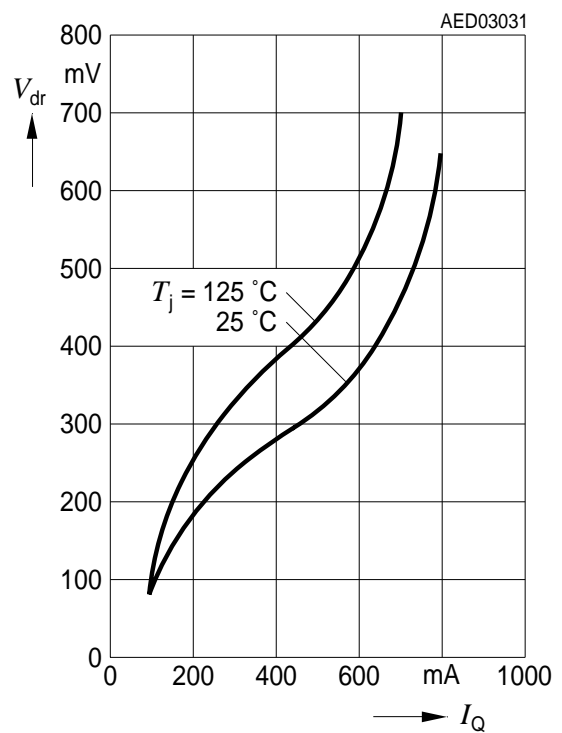

**Charge Current $I_{D,c}$
versus Temperature T_j**

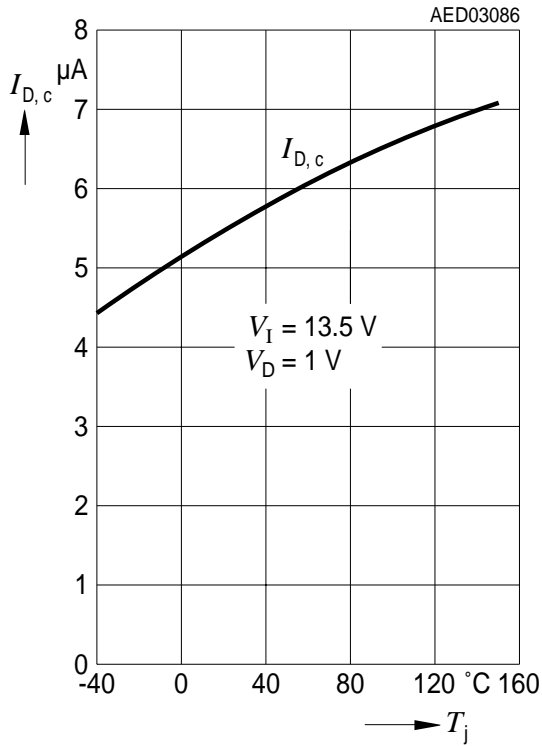

**Delay Switching Threshold V_{DU} , V_{DRL}
versus Temperature T_j**

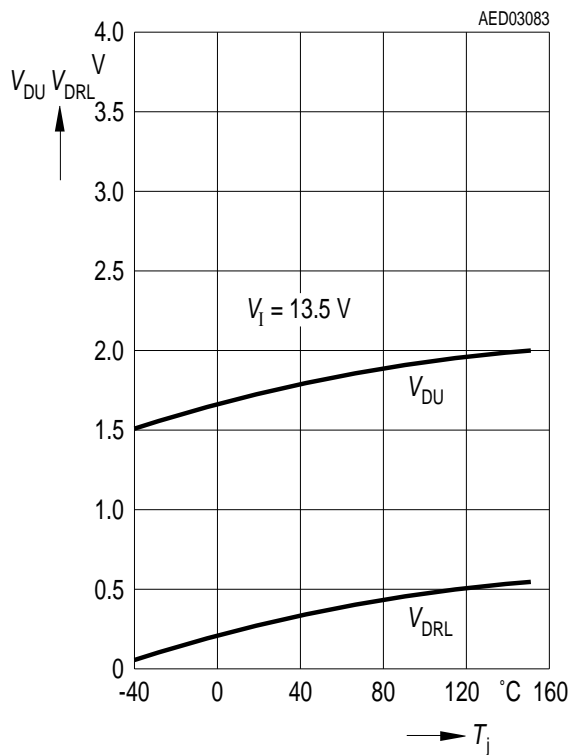

Package Outlines

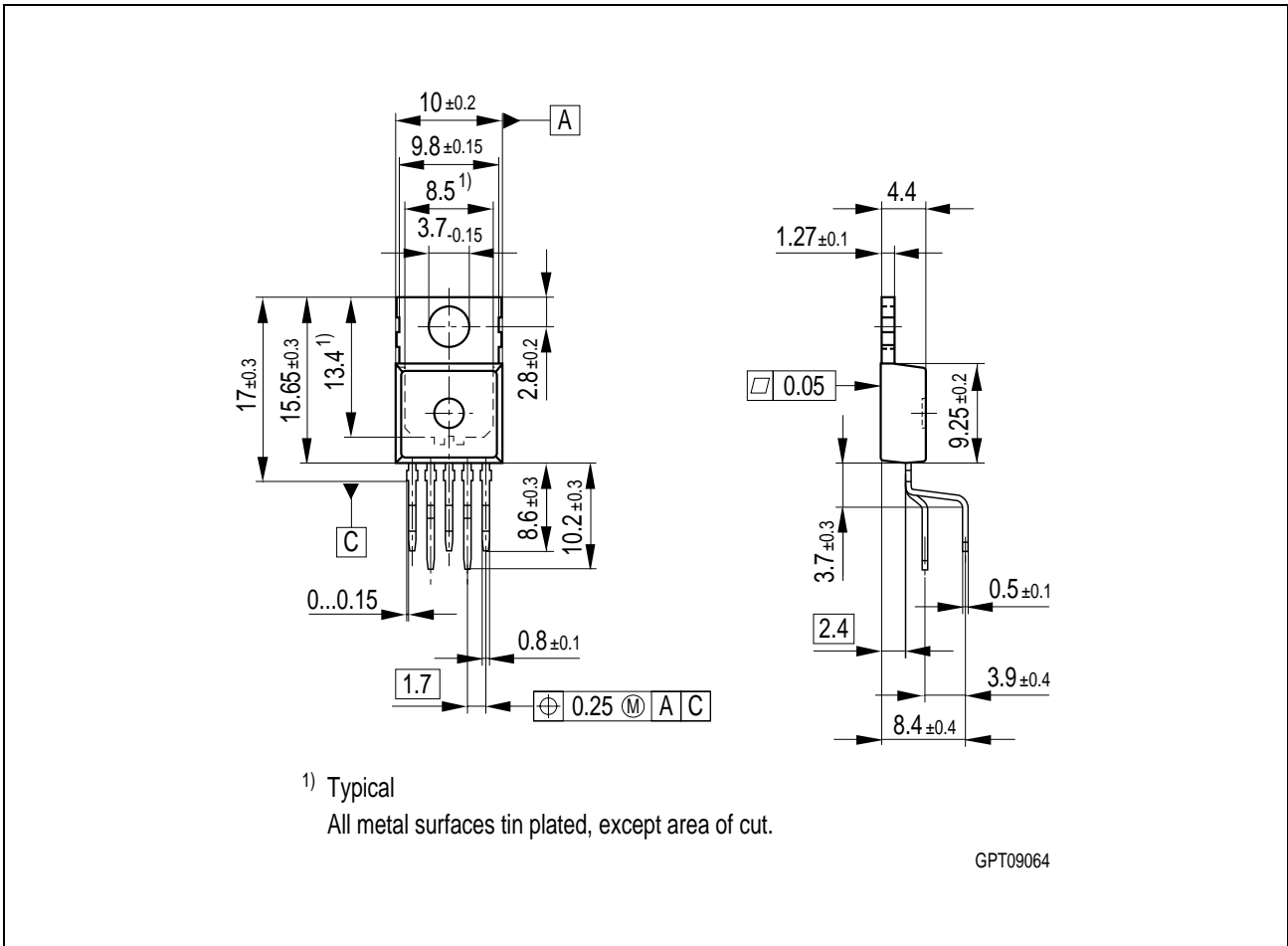

Figure 5 PG-TO220-5-11 (Plastic Transistor Single Outline)

Green Product (RoHS compliant)

To meet the world-wide customer requirements for environmentally friendly products and to be compliant with government regulations the device is available as a green product. Green products are RoHS-Compliant (i.e Pb-free finish on leads and suitable for Pb-free soldering according to IPC/JEDEC J-STD-020).

You can find all of our packages, sorts of packing and others in our Infineon Internet Page "Products": <http://www.infineon.com/products>.

SMD = Surface Mounted Device

Dimensions in mm

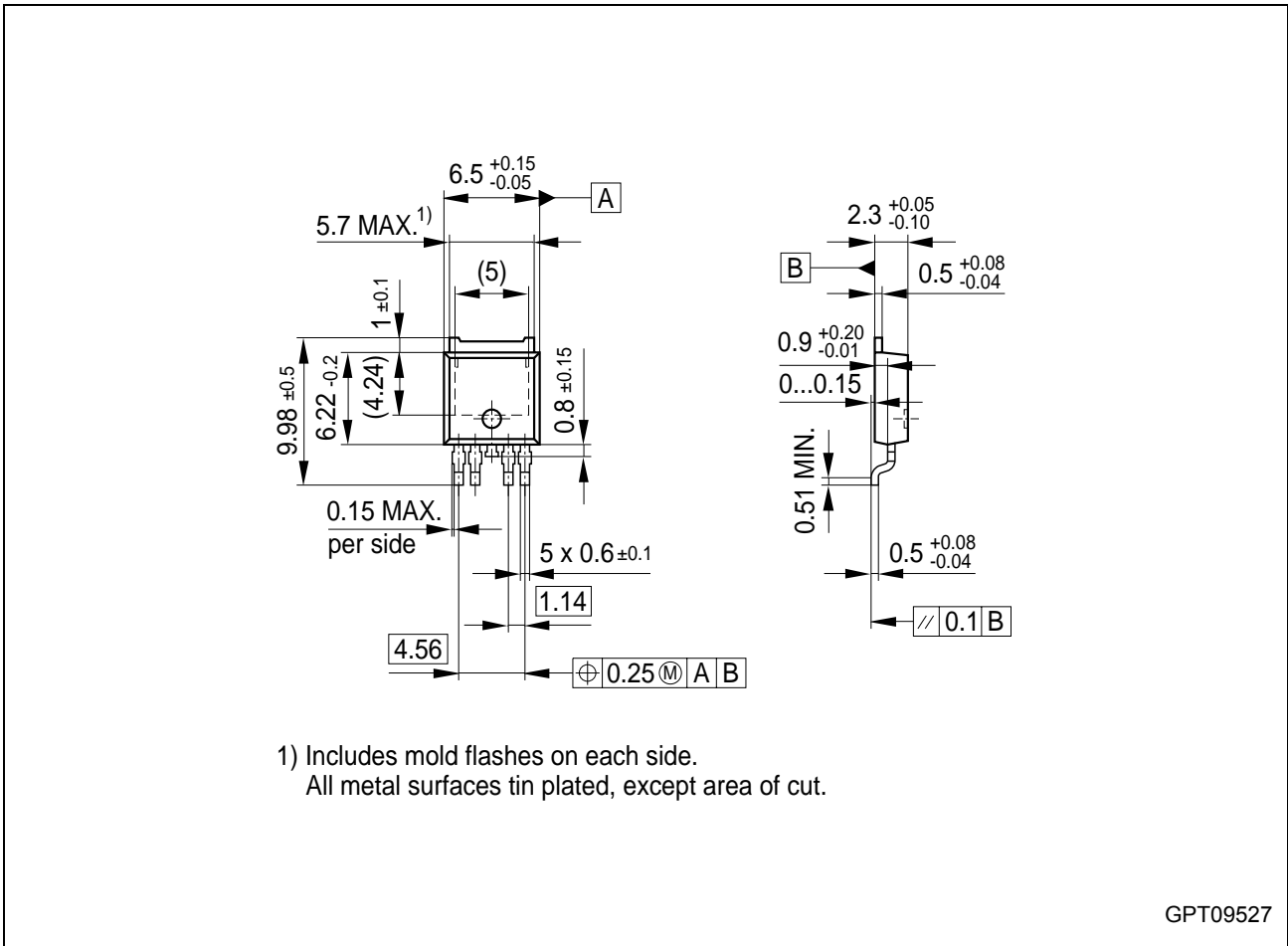

Figure 6 PG-TO252-5-11 (Plastic Transistor Single Outline)

Green Product (RoHS compliant)

To meet the world-wide customer requirements for environmentally friendly products and to be compliant with government regulations the device is available as a green product. Green products are RoHS-Compliant (i.e Pb-free finish on leads and suitable for Pb-free soldering according to IPC/JEDEC J-STD-020).

You can find all of our packages, sorts of packing and others in our Infineon Internet Page "Products": <http://www.infineon.com/products>.

SMD = Surface Mounted Device

Dimensions in mm

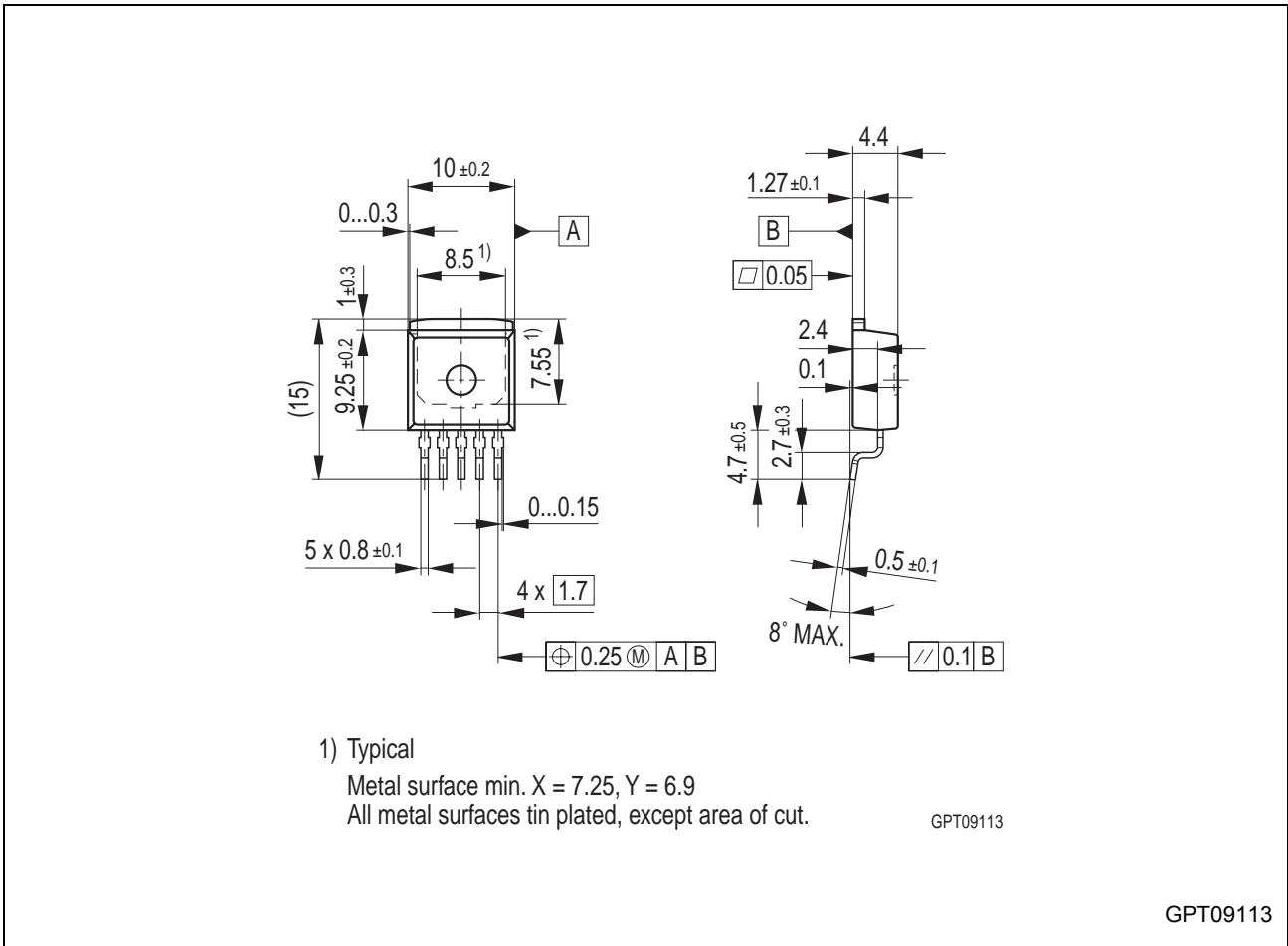

Figure 7 PG-TO263-5-1 (Plastic Transistor Single Outline)

Green Product (RoHS compliant)

To meet the world-wide customer requirements for environmentally friendly products and to be compliant with government regulations the device is available as a green product. Green products are RoHS-Compliant (i.e Pb-free finish on leads and suitable for Pb-free soldering according to IPC/JEDEC J-STD-020).

You can find all of our packages, sorts of packing and others in our Infineon Internet Page "Products": <http://www.infineon.com/products>.

SMD = Surface Mounted Device

Dimensions in mm

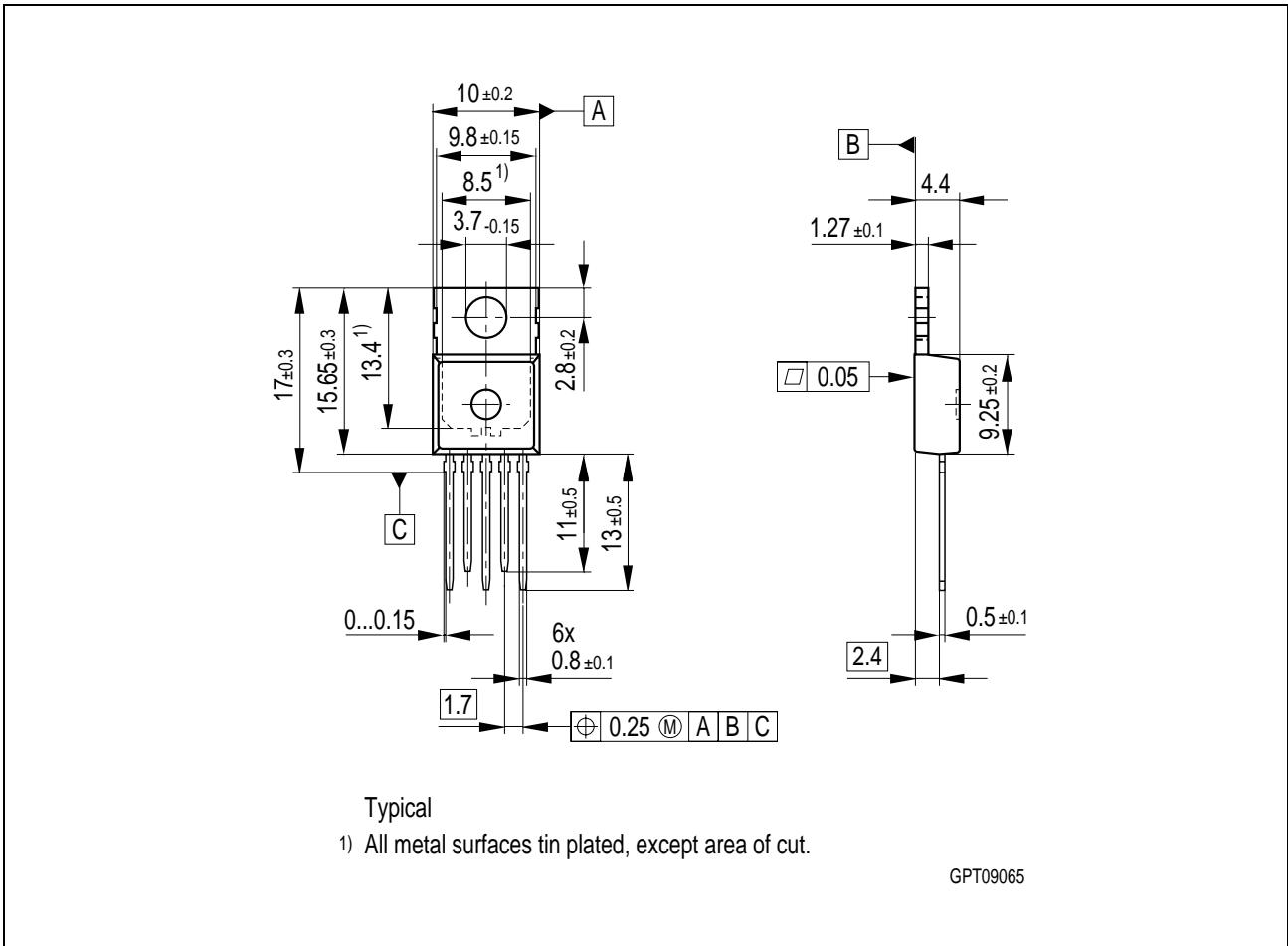

Figure 8 PG-TO220-5-12 (Plastic Transistor Single Outline)

Green Product (RoHS compliant)

To meet the world-wide customer requirements for environmentally friendly products and to be compliant with government regulations the device is available as a green product. Green products are RoHS-Compliant (i.e Pb-free finish on leads and suitable for Pb-free soldering according to IPC/JEDEC J-STD-020).

You can find all of our packages, sorts of packing and others in our Infineon Internet Page "Products": <http://www.infineon.com/products>.

SMD = Surface Mounted Device

Dimensions in mm

TLE 4275**Revision History:** **2007-02-19** Rev. 1.7

Previous Version: 1.6

Page	Subjects (major changes since last revision)
general	Removed all information related to the TLE4275v33 Product Proposal. (See separate datasheet for the TLE4275v33)
general	Updated Infineon logo
#1	Added "AEC" and "Green" logo
#1	Added "Green Product" and "AEC qualified" to the feature list
#1	Updated Package Names to "PG-xxx"
general	Removed leadframe variant "P-TO-252-1"
#12 to #15	Added "Green Product" remark
#17	Disclaimer Update

Edition 2007-02-19

**Published by
Infineon Technologies AG
81726 München, Germany
© Infineon Technologies AG 2007.
All Rights Reserved.**

Legal Disclaimer

The information given in this document shall in no event be regarded as a guarantee of conditions or characteristics ("Beschaffenheitsgarantie"). With respect to any examples or hints given herein, any typical values stated herein and/or any information regarding the application of the device, Infineon Technologies hereby disclaims any and all warranties and liabilities of any kind, including without limitation warranties of non-infringement of intellectual property rights of any third party.

Information

For further information on technology, delivery terms and conditions and prices please contact your nearest Infineon Technologies Office (www.infineon.com).

Warnings

Due to technical requirements components may contain dangerous substances. For information on the types in question please contact your nearest Infineon Technologies Office.

Infineon Technologies Components may only be used in life-support devices or systems with the express written approval of Infineon Technologies, if a failure of such components can reasonably be expected to cause the failure of that life-support device or system, or to affect the safety or effectiveness of that device or system. Life support devices or systems are intended to be implanted in the human body, or to support and/or maintain and sustain and/or protect human life. If they fail, it is reasonable to assume that the health of the user or other persons may be endangered.

Mouser Electronics

Authorized Distributor

Click to View Pricing, Inventory, Delivery & Lifecycle Information:

[Infineon:](#)

[TLE42754D](#) [TLE4275](#) [TLE4275D](#) [TLE4275G](#) [TLE4275S](#) [TLE4275DXT](#)