

COMPLEMENTARY NPN / PNP SMALL SIGNAL TRANSISTOR IN SOT363

Features

- Epitaxial Planar Die Construction
- Complementary Pair: 1 5551 Type NPN
1 5401 Type PNP
- Ideal for Medium Power Amplification and Switching
- Ultra-Small Surface Mount Package
- **Totally Lead-Free & Fully RoHS Compliant (Notes 1 & 2)**
- **Halogen and Antimony Free. "Green" Device (Note 3)**
- **Qualified to AEC-Q101 Standards for High Reliability**

Mechanical Data

- Case: SOT363
- Case Material: Molded Plastic, "Green" Molding Compound, UL Flammability Classification Rating 94V-0
- Moisture Sensitivity: Level 1 per J-STD-020
- Terminals: Finish — Matte Tin Finish. Solderable per MIL-STD-202, Method 208 
- Weight: 0.006 grams (Approximate)



Top View

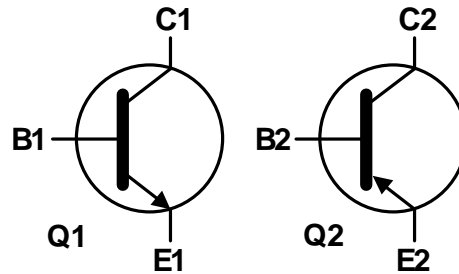

Device Symbol

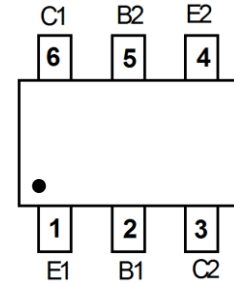

Top View Pin-Out

Ordering Information (Note 4)

Part Number	Compliance	Marking	Reel Size (inches)	Tape Width (mm)	Quantity Per Reel
MMDT5451-7-F	AEC-Q101	KNM	7	8	3,000

- Notes:
1. No purposely added lead. Fully EU Directive 2002/95/EC (RoHS), 2011/65/EU (RoHS 2) & 2015/863/EU (RoHS 3) compliant.
 2. See <https://www.diodes.com/quality/lead-free/> for more information about Diodes Incorporated's definitions of Halogen- and Antimony-free, "Green" and Lead-free.
 3. Halogen- and Antimony-free "Green" products are defined as those which contain <900ppm bromine, <900ppm chlorine (<1500ppm total Br + Cl) and <1000ppm antimony compounds.
 4. For packaging details, go to our website at <https://www.diodes.com/design/support/packaging/diodes-packaging/>.

Marking Information

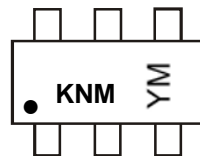

KNM = Product Type Marking Code
 YM = Date Code Marking
 Y = Year (ex: F = 2018)
 M = Month (ex: 9 = September)

Date Code Key

Year	2017	2018	2019	2020	2021	2022	2023	2024	2025
Code	E	F	G	H	I	J	K	L	M

Month	Jan	Feb	Mar	Apr	May	Jun	Jul	Aug	Sep	Oct	Nov	Dec
Code	1	2	3	4	5	6	7	8	9	O	N	D

Absolute Maximum Ratings – NPN 5551 Section (@T_A = +25°C, unless otherwise specified.)

Characteristic	Symbol	Value	Unit
Collector-Base Voltage	V _{CBO}	180	V
Collector-Emitter Voltage	V _{CEO}	160	V
Emitter-Base Voltage	V _{EBO}	6	V
Continuous Collector Current	I _C	200	mA

Absolute Maximum Ratings – PNP 5401 Section (@T_A = +25°C, unless otherwise specified.)

Characteristic	Symbol	Value	Unit
Collector-Base Voltage	V _{CBO}	-160	V
Collector-Emitter Voltage	V _{CEO}	-150	V
Emitter-Base Voltage	V _{EBO}	-6	V
Continuous Collector Current	I _C	-200	mA

Thermal Characteristics (@T_A = +25°C, unless otherwise specified.)

Characteristic	Symbol	Value	Unit
Power Dissipation	P _D	(Note 5)	200
		(Notes 6 & 7)	320
Thermal Resistance, Junction to Ambient	R _{θJA}	(Note 5)	625
		(Notes 6 & 7)	390
Thermal Resistance, Junction to Case	R _{θJC}	140	°C/W
Operating and Storage Temperature Range	T _J , T _{STG}	-55 to +150	

- Notes:
5. For a device mounted on minimum recommended pad layout 1oz weight copper that is on a single-sided FR-4 PCB; device is measured under still air conditions whilst operating in a steady-state.
 6. Same as Note 5, except the device is mounted on 25mm X 25mm 2oz copper.
 7. Maximum combined dissipation.
 8. Thermal resistance from junction to the top of package.

Electrical Characteristics – NPN 5551 Section (@T_A = +25°C, unless otherwise specified.)

Characteristic	Symbol	Min	Typ	Max	Unit	Test Condition
OFF CHARACTERISTICS						
Collector-Base Breakdown Voltage	BV _{CBO}	180	—	—	V	I _C = 100μA, I _E = 0
Collector-Emitter Breakdown Voltage (Note 9)	BV _{CEO}	160	—	—	V	I _C = 1mA, I _B = 0
Emitter-Base Breakdown Voltage	BV _{EBO}	6	—	—	V	I _E = 10μA, I _C = 0
Collector-Base Cutoff Current	I _{CBO}	—	—	50	nA	V _{CB} = 120V, I _E = 0
		—	—	50	μA	V _{CB} = 120V, I _E = 0, T _A = +100°C
Base-Emitter Cutoff Current	I _{EBO}	—	—	50	nA	V _{EB} = 4V, I _C = 0
ON CHARACTERISTICS (Note 9)						
DC Current Gain	h _{FE}	80	—	—	—	I _C = 1.0mA, V _{CE} = 5.0V
		80	—	250	—	I _C = 10mA, V _{CE} = 5.0V
		30	—	—	—	I _C = 50mA, V _{CE} = 5.0V
Collector-Emitter Saturation Voltage	V _{CE(SAT)}	—	—	0.15	V	I _C = 10mA, I _B = 1.0mA
		—	—	0.20	V	I _C = 50mA, I _B = 5.0mA
Base-Emitter Saturation Voltage	V _{BE(SAT)}	—	—	1.0	V	I _C = 10mA, I _B = 1.0mA
		—	—	1.0	V	I _C = 50mA, I _B = 5.0mA
SMALL SIGNAL CHARACTERISTICS						
Output Capacitance	C _{obo}	—	—	6.0	pF	V _{CB} = 10V, f = 1.0MHz, I _E = 0
Small Signal Current Gain	h _{fe}	50	—	250	—	I _C = 1mA, V _{CE} = 10V, f = 1.0MHz
Current Gain-Bandwidth Product	f _T	100	—	300	MHz	I _C = 10mA, V _{CE} = 10V, f = 100MHz
Noise Figure	NF	—	—	8.0	dB	V _{CE} = 5.0V, I _C = 200μA, R _S = 1kΩ, f = 1.0kHz

Electrical Characteristics – PNP 5401 Section (@T_A = +25°C, unless otherwise specified.)

Characteristic	Symbol	Min	Typ	Max	Unit	Test Condition
OFF CHARACTERISTICS						
Collector-Base Breakdown Voltage	BV _{CBO}	-160	—	—	V	I _C = -100μA, I _E = 0
Collector-Emitter Breakdown Voltage (Note 9)	BV _{CEO}	-150	—	—	V	I _C = -1mA, I _B = 0
Emitter-Base Breakdown Voltage	BV _{EBO}	-6	—	—	V	I _E = -10μA, I _C = 0
Collector-Base Cutoff Current	I _{CBO}	—	—	-50	nA	V _{CB} = -120V, I _E = 0
		—	—	-50	μA	V _{CB} = -120V, I _E = 0, T _A = +100°C
Base-Emitter Cutoff Current	I _{EBO}	—	—	-50	nA	V _{EB} = -4V, I _C = 0
ON CHARACTERISTICS (Note 9)						
DC Current Gain	h _{FE}	50	—	—	—	I _C = -1.0mA, V _{CE} = -5.0V
		60	—	240	—	I _C = -10mA, V _{CE} = -5.0V
		50	—	—	—	I _C = -50mA, V _{CE} = -5.0V
Collector-Emitter Saturation Voltage	V _{CE(SAT)}	—	—	-0.20	V	I _C = -10mA, I _B = -1.0mA
		—	—	-0.50	V	I _C = -50mA, I _B = -5.0mA
Base-Emitter Saturation Voltage	V _{BE(SAT)}	—	—	-1.0	V	I _C = -10mA, I _B = -1.0mA
		—	—	-1.0	V	I _C = -50mA, I _B = -5.0mA
SMALL SIGNAL CHARACTERISTICS						
Output Capacitance	C _{obo}	—	—	6.0	pF	V _{CB} = -10V, f = 1.0MHz, I _E = 0
Small Signal Current Gain	h _{fe}	40	—	260	—	I _C = -1mA, V _{CE} = -10V, f = 1.0MHz
Current Gain-Bandwidth Product	f _T	100	—	300	MHz	I _C = -10mA, V _{CE} = -10V, f = 100MHz
Noise Figure	NF	—	—	8.0	dB	V _{CE} = -5.0V, I _C = -200μA, R _S = 1Ω, f = 1.0kHz

Note: 9. Measured under pulsed conditions. Pulse width ≤ 300μs. Duty cycle ≤ 2%.

Typical Electrical Characteristics – NPN 5551 Section (@ $T_A = +25^\circ\text{C}$, unless otherwise specified.)

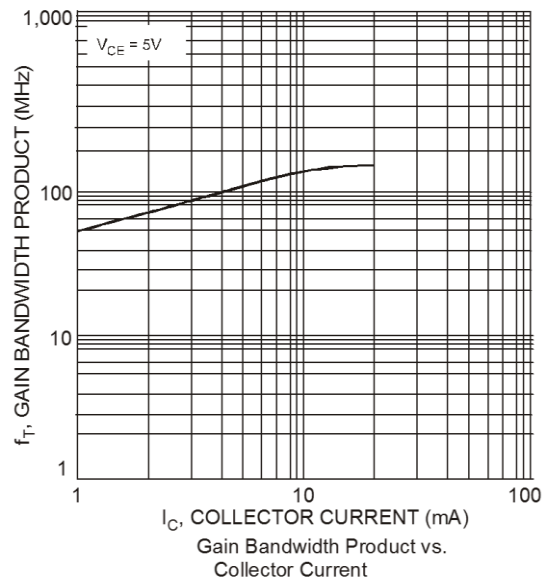
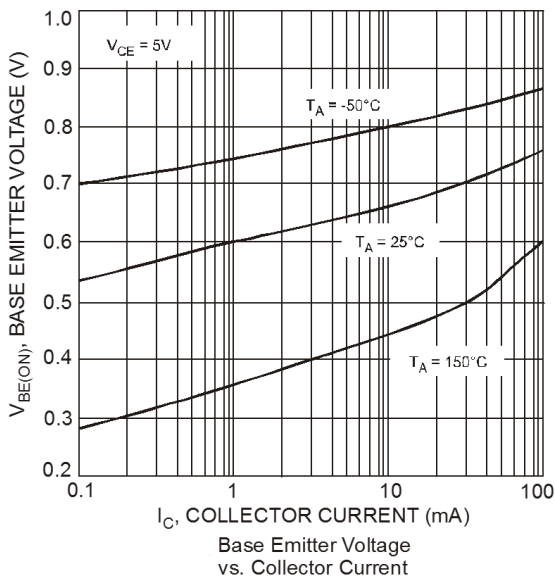
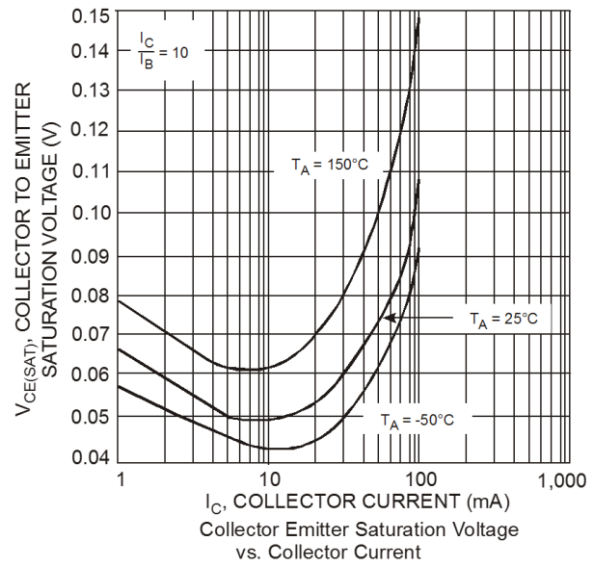
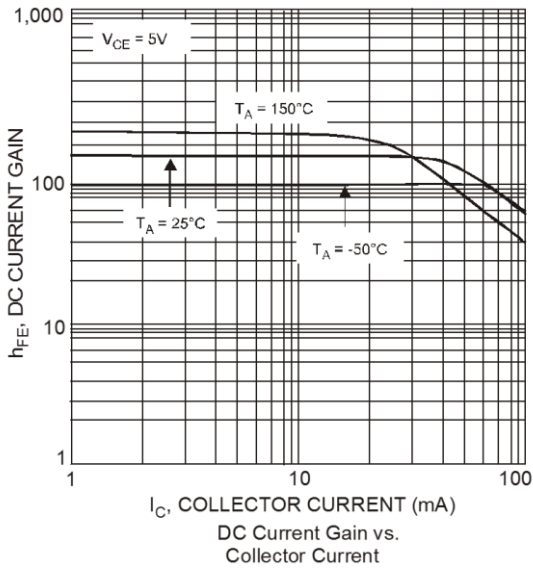

Typical Electrical Characteristics – PNP 5401 Section (@ $T_A = +25^\circ\text{C}$, unless otherwise specified.)

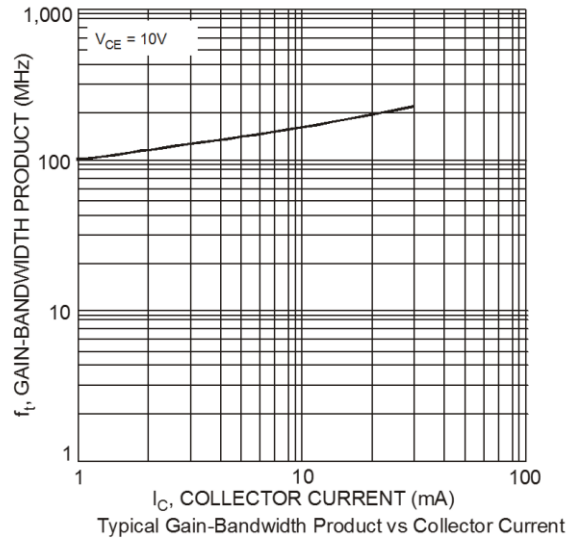
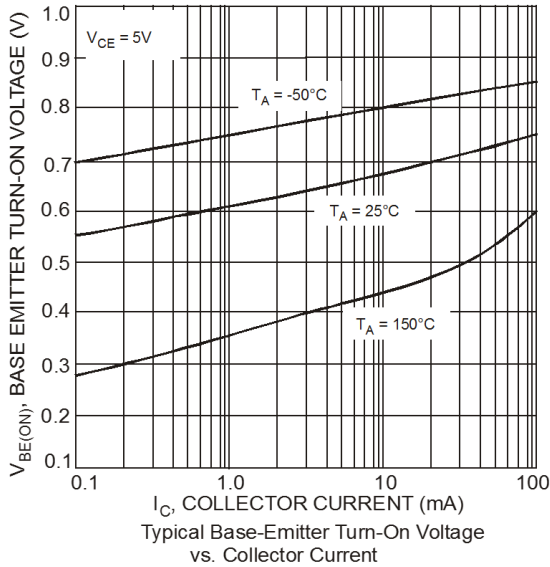
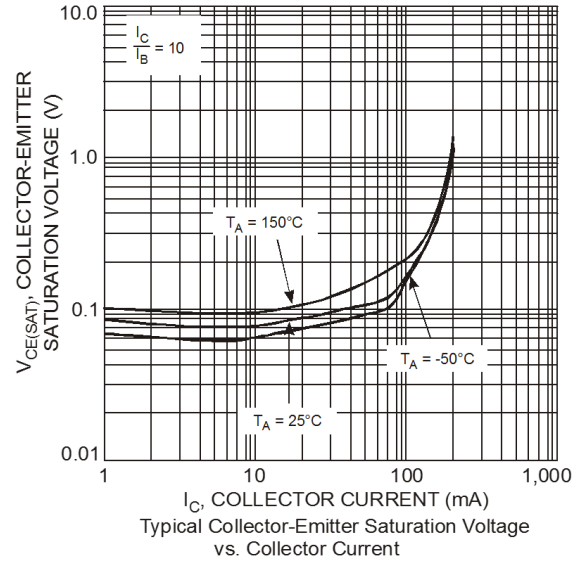
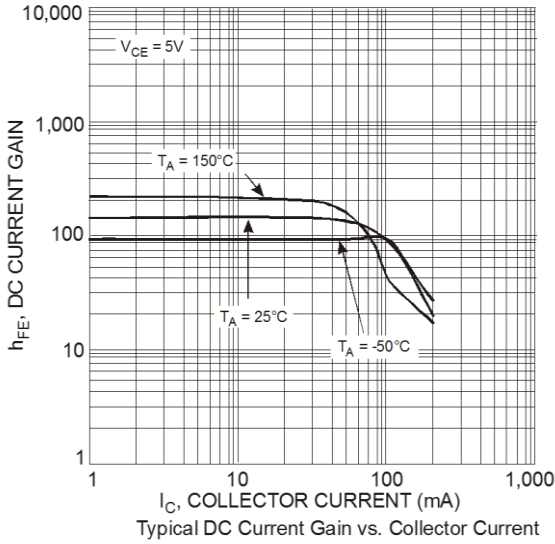

Package Outline Dimensions

Please see <http://www.diodes.com/package-outlines.html> for the latest version.

SOT363

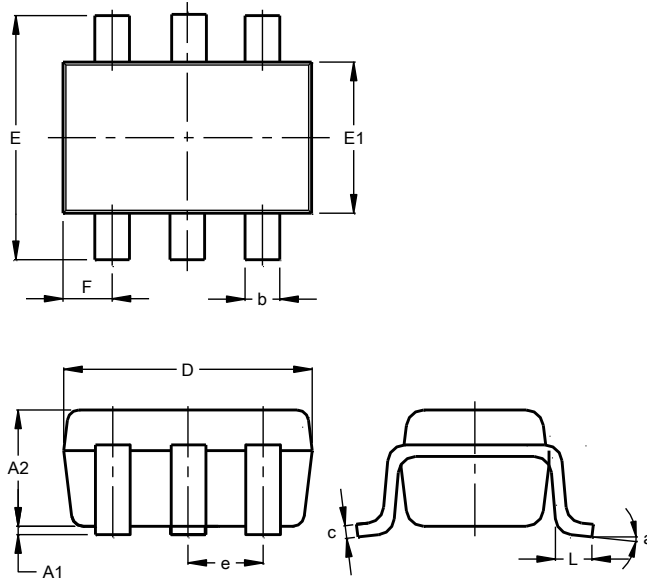

SOT363			
Dim	Min	Max	Typ
A1	0.00	0.10	0.05
A2	0.90	1.00	0.95
b	0.10	0.30	0.25
c	0.10	0.22	0.11
D	1.80	2.20	2.15
E	2.00	2.20	2.10
E1	1.15	1.35	1.30
e	0.650 BSC		
F	0.40	0.45	0.425
L	0.25	0.40	0.30
a	0°	8°	--
All Dimensions in mm			

Suggested Pad Layout

Please see <http://www.diodes.com/package-outlines.html> for the latest version.

SOT363

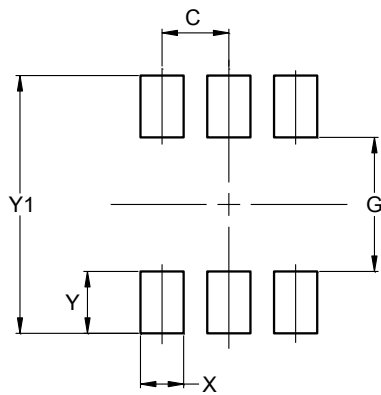

Dimensions	Value (in mm)
C	0.650
G	1.300
X	0.420
Y	0.600
Y1	2.500

Note: For high voltage applications, the appropriate industry sector guidelines should be considered with regards to creepage and clearance distances between device Terminals and PCB tracking.

IMPORTANT NOTICE

DIODES INCORPORATED MAKES NO WARRANTY OF ANY KIND, EXPRESS OR IMPLIED, WITH REGARDS TO THIS DOCUMENT, INCLUDING, BUT NOT LIMITED TO, THE IMPLIED WARRANTIES OF MERCHANTABILITY AND FITNESS FOR A PARTICULAR PURPOSE (AND THEIR EQUIVALENTS UNDER THE LAWS OF ANY JURISDICTION).

Diodes Incorporated and its subsidiaries reserve the right to make modifications, enhancements, improvements, corrections or other changes without further notice to this document and any product described herein. Diodes Incorporated does not assume any liability arising out of the application or use of this document or any product described herein; neither does Diodes Incorporated convey any license under its patent or trademark rights, nor the rights of others. Any Customer or user of this document or products described herein in such applications shall assume all risks of such use and will agree to hold Diodes Incorporated and all the companies whose products are represented on Diodes Incorporated website, harmless against all damages.

Diodes Incorporated does not warrant or accept any liability whatsoever in respect of any products purchased through unauthorized sales channel. Should Customers purchase or use Diodes Incorporated products for any unintended or unauthorized application, Customers shall indemnify and hold Diodes Incorporated and its representatives harmless against all claims, damages, expenses, and attorney fees arising out of, directly or indirectly, any claim of personal injury or death associated with such unintended or unauthorized application.

Products described herein may be covered by one or more United States, international or foreign patents pending. Product names and markings noted herein may also be covered by one or more United States, international or foreign trademarks.

This document is written in English but may be translated into multiple languages for reference. Only the English version of this document is the final and determinative format released by Diodes Incorporated.

LIFE SUPPORT

Diodes Incorporated products are specifically not authorized for use as critical components in life support devices or systems without the express written approval of the Chief Executive Officer of Diodes Incorporated. As used herein:

A. Life support devices or systems are devices or systems which:

1. are intended to implant into the body, or
2. support or sustain life and whose failure to perform when properly used in accordance with instructions for use provided in the labeling can be reasonably expected to result in significant injury to the user.

B. A critical component is any component in a life support device or system whose failure to perform can be reasonably expected to cause the failure of the life support device or to affect its safety or effectiveness.

Customers represent that they have all necessary expertise in the safety and regulatory ramifications of their life support devices or systems, and acknowledge and agree that they are solely responsible for all legal, regulatory and safety-related requirements concerning their products and any use of Diodes Incorporated products in such safety-critical, life support devices or systems, notwithstanding any devices- or systems-related information or support that may be provided by Diodes Incorporated. Further, Customers must fully indemnify Diodes Incorporated and its representatives against any damages arising out of the use of Diodes Incorporated products in such safety-critical, life support devices or systems.

Copyright © 2018, Diodes Incorporated

www.diodes.com

Mouser Electronics

Authorized Distributor

Click to View Pricing, Inventory, Delivery & Lifecycle Information:

[Diodes Incorporated:](#)

[MMDT5451-7-F](#)