

Digital Time Switch H5S

CSM_H5S_DS_E_9_2

Easier, More Convenient Time Switches, with New 4-circuit Output and Yearly Models in Addition to 2-circuit Weekly Models



- Independent Day Keys provide easier operation.
- Temporary holiday setting function makes it easy to turn OFF output for holidays and non-operating days.
- Settings can be made even with the Time Switch turned OFF.
- Test mode enables easy program checking.
- Complies with EMC Directives, UL/CSA, and other safety standards.
- Includes summer time (DST) adjustment. Yearly models also offer automatic switching to DST.
- Set value can be changed both upward and downward for speedier setting.
- Integrated temperature compensation circuit helps keep accurate time over a wide temperature range. (See note 1.)
- Includes time counter and total counter functions with alarm indicator. (See note 2.)
- Bank function allows program switching by an external input. (See note 3.)
- New 4-circuit output models with a compact, 72 × 72-mm DIN size added to the series.

- Note:**
1. Available only on yearly models.
 2. Available only on 2-circuit models.
 3. Available only on weekly models.



For the most recent information on models that have been certified for safety standards, refer to your OMRON website.

Features

Easier and More Convenient to Use

Simple Setting

Independent Day Keys make setting easy.

Up/down set value changing for speedy setting.

Temporary holidays (non-operating days) are also easy to set.

Weekly models: Specify the day.
Yearly models: Specify the date.

Convenient Functions

Time Counter/Total Counter Functions (See note.)

This function makes it possible to monitor the total time that a load has been applied, or the total number of operating cycles. It allows the Time Switch to be used for managing maintenance.

With alarm indicator

Shows total lamp ON time

Time Adjustment Function (See note.)

The time can be set to 00 min 00 s by using an external input. The times on multiple Time Switches can also be easily synchronized.

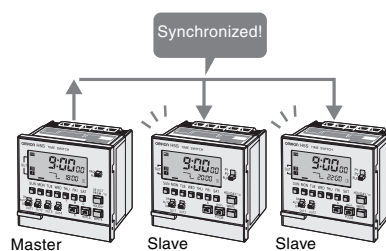

Note: Equipped on 2-circuit models.

More Applications on New Series Models

Yearly Models

Automatic Program Switching by Seasons

The yearly operation can be set to automatically change the weekly program depending on the season. (See note.)

Mar	Apr	May	Jun	Jul	Aug	Sep	Oct	Nov	Dec	Jan	Feb
Spring			Summer			Autumn			Winter		
Season (See note 2.)	Spring	Summer	Autumn	Winter							
Program example	17:30 ON ▼ 21:00 OFF	19:00 ON ▼ 22:00 OFF	18:00 ON ▼ 21:00 OFF	17:00 ON ▼ 21:00 OFF							

Note: Up to four seasons can be set for 4-circuit models, and up to two seasons for 2-circuit models.

Temperature Compensation Circuit Maintains Accurate Time

A temperature compensation circuit is provided in the yearly models to maintain accurate time keeping even when the ambient temperature varies greatly. This ensures precise operation with minimal time lags all year round, regardless of temperature changes.



4-circuit Models

Space-saving, Economical 4-circuit Models Added to the Series

The new 4-circuit models are 72 × 72-mm DIN size. Their space-saving size allows use in more applications.

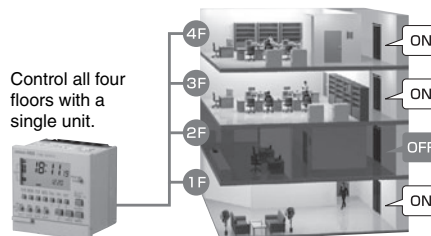

Model Number Structure

Model Number Legend

Note: This model number legend includes combinations that are not available. Please check the “List of Models” for availability.

H5S- □□□□□ - □
1 2 3 4 5 6

1. Control cycle

- W: Weekly
- Y: Yearly

2. Mounting method

- None: Flush mounting
- F: Surface mounting/track mounting

3. Panel language

- B: English
- A: Japanese

4. Number of outputs

- 2: 2 circuits
- 4: 4 circuits

5. Supply voltage

- None: 100 to 240 VAC
- D: 24 VDC

6. Time accuracy

- None: Standard
- X: With temperature compensation

Ordering Information

List of Models

Control cycle	Number of outputs	Mounting method	Supply voltage	Models
Weekly	2 circuits	Flush mounting	100 to 240 VAC	H5S-WB2
			24 VDC	H5S-WB2D
		Surface mounting/ track mounting	100 to 240 VAC	H5S-WFB2
			24 VDC	H5S-WFB2D
Yearly	2 circuits	Flush mounting	100 to 240 VAC	H5S-YB2-X
			24 VDC	H5S-YB2D-X
		Surface mounting/ track mounting	100 to 240 VAC	H5S-YFB2-X
			24 VDC	H5S-YFB2D-X
	4 circuits	Flush mounting	100 to 240 VAC	H5S-YB4-X
			24 VDC	H5S-YB4D-X
		Surface mounting/ track mounting	100 to 240 VAC	H5S-YFB4-X
			24 VDC	H5S-YFB4D-X

Accessories (Order Separately)

Name	Model
Protective Cover	Y92A-72C
Track Mounting Base	Y92F-90
Large Terminal Cover (in pairs)	Y92A-72H

Specifications

Ratings

Item		Weekly 2-circuit Models (H5S-W□2)	Yearly 2-circuit Models (H5S-Y□2)	Yearly 4-circuit Models (H5S-Y□4)
Rated supply voltage		100 to 240 VAC (50/60 Hz), 24 VDC (See note 1.)		
Operating voltage range		AC: 85% to 110% rated supply voltage DC: 85% to 120% rated supply voltage		
Power consumption		Approx. 2.9 VA at 264 VAC 60 Hz Approx. 0.8 W at 28.8 VDC	Approx. 3.2 VA at 264 VAC 60 Hz Approx. 0.9 W at 28.8 VDC	Approx. 3.5 VA at 264 VAC 60 Hz Approx. 1.0 W at 28.8 VDC
Control outputs	Number of circuits	SPST-NO × 2 circuits		SPST-NO × 4 circuits
	Circuits	Power supply circuit and other (no-voltage) circuit		
	Capacity	Resistive load ($\cos\phi = 1$)	15 A at 250 VAC (See note 2.)	
		Inductive load	10 A at 250 VAC ($\cos\phi = 0.7$)	
Ambient operating temperature		-10 to 55°C (with no icing or condensation)		
Ambient operating humidity		25 to 85%		
Storage temperature		-25 to 65°C (with no icing or condensation)		
Case color		Light gray (Munsell 5Y7/1)		

Note: 1. Do not use inverter output as a power supply. For details, refer to *Precautions for Safe Use*, item 24, on page 12.

2. The capacity is 15 A per circuit, but derating of the total current for two circuits is required as shown below depending on the ambient temperature.

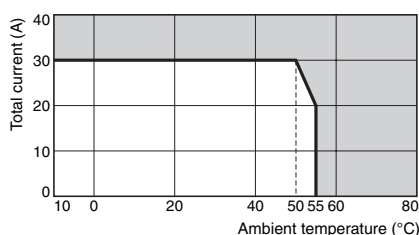

■ Characteristics

Item		Weekly 2-circuit Models (H5S-W□2)	Yearly 2-circuit Models (H5S-Y□2)	Yearly 4-circuit Models (H5S-Y□4)
Accuracy of operating time		±0.01%±0.05 s max. (See note 1.) The ±0.01% value applies to the set time interval.		
Setting error				
Influence of voltage				
Influence of temperature				
Cyclic error		±15 s per month (at 25°C)	±15 s per month (at -10 to 45°C), ±20 s per month (at 45 to 55°C)	
Memory protection		Continuous use: 5 years min. (at 25°C) (See note 2.)		
Insulation resistance		100 MΩ min. (between current-carrying terminals and exposed non-current carrying metal parts, between operation circuit and control output circuit, between control output circuits, and between non-continuous contacts.)		
Dielectric strength		2,950 VAC, 50/60 Hz for 1 min (between current-carrying terminals and exposed non-current carrying metal parts) 2,000 VAC, 50/60 Hz for 1 min (between operation circuit and control output circuit, and between control output circuits) 1,000 VAC, 50/60 Hz for 1 min (between non-continuous contacts)		
Noise immunity		±1,500 V (between power terminals, for AC power models), ±500 V (between power terminals, for DC power models) Square-wave noise by noise simulator (pulse width: 100 ns, for 1 μs, 1-ns rise time)		
Vibration resistance	Destruction	10 to 55 Hz with 0.375-mm single amplitude in 3 directions for 2 hours each		
	Malfunction	10 to 55 Hz with 0.25-mm single amplitude in 3 directions for 10 minutes each		
Shock resistance	Destruction	300 m/s ² 3 times each in x, y, and z axes, 6 directions		
	Malfunction	100 m/s ² 3 times each in x, y, and z axes, 6 directions		
Life expectancy	Mechanical	100,000 operations min.		
	Electrical	50,000 operations min. (15 A at 250 VAC, resistive load) 50,000 operations min. (10 A at 30 VDC, resistive load) 50,000 operations min. (10 A at 250 VAC, inductive load (cosφ = 0.7)) 50,000 operations min. (1 HP at 250 VAC, motor load) 50,000 operations min. (100 W at 100 VAC, lamp load) 10,000 operations min. (300 W at 100 VAC, lamp load)		50,000 operations min. (3 A at 250 VAC, resistive load) 50,000 operations min. (3 A at 30 VDC, resistive load)
Approved standards		cURus: UL 508/CSA C22.2 No.14, Conforms to EN 60730-2-7(Pollution degree 2/overvoltage category II), Conforms to VDE 0106/part100. Conforms to Electrical Appliance and Material Safety Law (for Japan)		
EMC		(EMI) EN 60730-2-7 EMI Radiated: EN 60730-2-7 (CISPR 22 Class B) EMI Conducted (Continuous): EN 60730-2-7 (CISPR 22 Class B) EMI Conducted (Non-continuous): EN 60730-2-7 (CISPR 14-1) Harmonic Current: EN 60730-2-7 (IEC 61000-3-2 Class A) Voltage fluctuation/flicker: EN 60730-2-7 (IEC 61000-3-3) (EMS) EN 60730-2-7 ESD Immunity: EN 60730-2-7 (IEC 61000-4-2): 6 kV contact discharge 8 kV air discharge Radiated Electromagnetic Field Immunity: EN 60730-2-7 (IEC 61000-4-3): 10-V/m AM modulation (80 MHz to 1 GHz, 1.4 GHz to 2 GHz) 10-V/m pulse modulation (900 MHz) Conducted Disturbance Immunity: EN 60730-2-7 (IEC 61000-4-6): 10 V (0.15 to 80 MHz) Burst Immunity: EN 60730-2-7 (IEC 61000-4-4): 2 kV power line 1 kV control line Surge Immunity: EN 60730-2-7 (IEC 61000-4-5): 1 kV line to line (power line, output line) 2 kV line to ground (power line, output line) 0.5 kV line to line (input line) 1 kV line to ground (input line) Voltage Dip/Interrupting Immunity: EN 60730-2-7 (IEC 61000-4-11): 0.5-s cycle, 100% (rated voltage)		
Weight		Approx. 200 g		

Note: 1. The total error including the repeat accuracy, setting error, variation due to voltage change, and variation due to temperature change is ±0.01% ±0.05 s max.

2. The time given for memory protection is the calculated time of when power is not being supplied (including during storage) at an ambient temperature of 25°C. The timer functions and set program are backed up by a lithium battery that is built into the Time Switch. These will be lost if the life of the battery expires. If the lithium battery is replaced (if the PCB is replaced), the stored contents will also be lost.

■ Operation

Item	Weekly 2-circuit Models (H5S-W□2)	Yearly 2-circuit Models (H5S-Y□2)	Yearly 4-circuit Models (H5S-Y□4)
Operation method	Digital quartz		
Operation period	1 week (7 days)	1 year (with integrated calendar to 2099)	
Display	<ul style="list-style-type: none"> Day, hrs (switchable between 24-hr indication and a.m./p.m. 12-hr indication), minutes, seconds (0.00 to 23:59, 0.00 to 11:59 a.m., 0.00 to 11:59 p.m.) Digital indication by LCD (character height: 10 mm) Digital display of operation schedule during operation Timing chart display of operation schedule during operation 		
Min. setting unit	1 min		
Number of steps that can be set	Weekly program (See note 1.)	40 steps/circuit	48 steps/circuit (See note 2.) 24 steps/circuit (per season) (See note 3.)
	Yearly program	---	4 yearly programs/circuit
	Number of settable yearly temporary holiday settings	---	16

Note: 1. Depending the operation, the following steps can be used for weekly programs.

- Timer operation: 2 steps
- Pulse-output operation: 1 step
- Cyclic operation: 4 steps

2. When the season switching setting is not being used.
3. When the season switching setting is being used.

■ Operation Functions

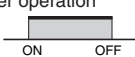
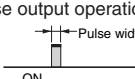
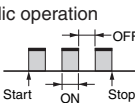
Item	Weekly 2-circuit Models (H5S-W□2)	Yearly 2-circuit Models (H5S-Y□2)	Yearly 4-circuit Models (H5S-Y□4)
Weekly timer operation		Controls the output according to the set time of ON and OFF. <ul style="list-style-type: none"> Min. setting unit: 1 min Multiple-day operation also possible. 	
Weekly pulse-output operation		Output turns ON for a fixed period (pulse width) at the set ON time. <ul style="list-style-type: none"> Pulse width: 1 to 59 s (in 1-s increments), or 1 to 60 min (in 1-min increments) The pulse width can be set for each step. 	
Weekly cyclic operation		Repeatedly turns ON and OFF during the period from the cyclic start time to the stop time. Independent ON- and OFF-time settings are possible. <ul style="list-style-type: none"> Min. setting unit: 1 min (The ON time width and OFF time width can each be set to between 1 minute and 11 hours 59 minutes.) <p>(The timer operation repeatedly turns the signal ON and OFF for the time widths specified by the ON time and OFF time during the period from the day of the week and time that are set for the cyclic start time to the day of the week and time that are set for the stop time.)</p>	
Yearly timer operation	---	Adds a yearly timer operation to the weekly timer program. For details, refer to <i>About Yearly Programs</i> on page 18.	
Yearly pulse-output operation	---	Adds a yearly pulse-output operation to the weekly pulse-output program. For details, refer to <i>About Yearly Programs</i> on page 18.	
Temporary holiday setting	Sets temporary holidays (non-operating days) without having to revise the existing program. For details, refer to <i>Setting Temporary Holidays (Weekly) and Setting Temporary Holidays (Yearly)</i> on page 20.		
Day override operation	Executes the operation for one day temporarily on another day in the 7-day period starting from the current day. For details, refer to <i>Day Override Operation</i> on page 21.	---	
Program check	Consecutively displays the days and times when the output is set to turn ON and OFF over the course of one week in the sequence in which the Time Switch is to operate. For details, refer to <i>Program Check Function</i> on page 21.		

Item	Weekly 2-circuit Models (H5S-W□2)	Yearly 2-circuit Models (H5S-Y□2)	Yearly 4-circuit Models (H5S-Y□4)
Checking the settings	Consecutively displays the times when the output is set to turn ON and OFF for one day in the sequence in which the Time Switch is to operate. For details, refer to <i>Checking the Settings</i> on page 21.		
Forced ON/OFF operation	Allows the output to be forcibly turned ON/OFF by the Output ON/OFF Switch regardless of the control output setting.		
Override and automatic return operation	Allows the control output to be maintained in the ON (or OFF) state until the next OFF (or ON) time. This operation is controlled by using the Output ON/OFF Switch and Write Key. When completed, the Time Switch automatically resumes the previously set operation. For details, refer to <i>Override and Automatic Return Operation</i> on page 22.		
Summertime (DST) adjustment	Switches the current time from “current time” to “current time + 1 h” for daylight savings time. Yearly models also offer automatic switching to daylight savings time. For details, refer to <i>Manual Summer Time (DST) Adjustment</i> on page 21.		
Time counter/total counter display	Displays the total elapsed time and total count of external input. It also displays a warning when a set value is entered. For details, refer to <i>Time Counter/Total Counter Display (F2, F3, F4)</i> on page 23.	---	
Time adjustment input	Allows the time to be set to 00 min 00 s at the same time as an external input is applied. For details, refer to <i>Time Adjustment Input Function (F2)</i> on page 24.	---	
Manual operation on recovery from power failure	Allows the output state to be specified following recovery from a power failure. For details, refer to <i>Manual Operation on Recovery from Power Failure (F2)</i> on page 24.	---	
Bank switching	Allows two groups (banks) of programs to be registered and switched by external input. For details, refer to <i>Bank Switching (F2)</i> on page 24.	---	
Season switching	---	Allows weekly programs to be automatically switched in response to seasons throughout the year. For details, refer to <i>Season Switching/Period of Season (F8/F9)</i> on page 24.	
Power OFF settings	Allows the display to remain lit even when the power is turned OFF, and settings to be made for all functions except Override and Automatic Return Operation. <ul style="list-style-type: none"> • The display illumination will turn OFF when there has been no operation for 2 min. The display will light again when any key other than a slide switch is pressed for at least 1 s. • No output will be generated. 		

Connections

Terminal Arrangement

H5S-□A□/-□B□ Flush Mounting Models

Two-circuit Models

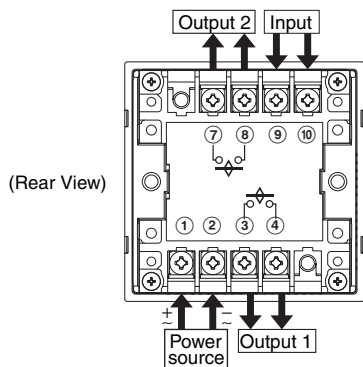

Four-circuit Models

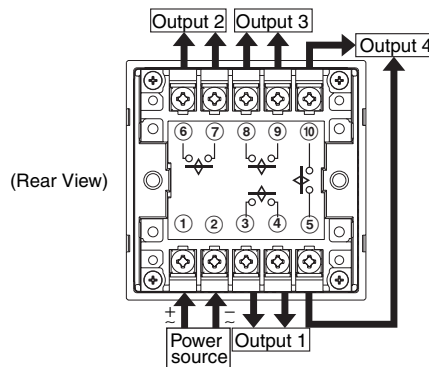

H5S-□FA□/-□FB□ Surface Mounting Models

Two-circuit Models

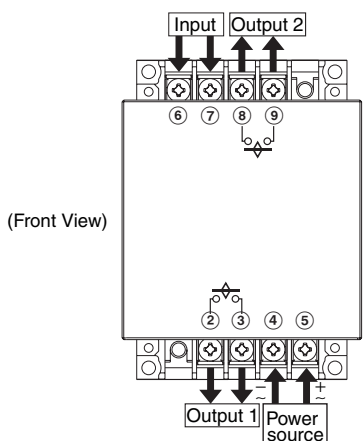

Four-circuit Models

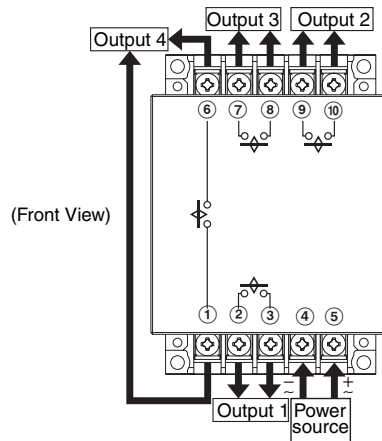

- Note:**
1. The Time Switch output uses a no-voltage contact. An external power supply is required for applications in which a load is driven.
 2. The output contact ratings are different for 2-circuit and 4-circuit models.

Input Connection (Two-circuit Models Only)

Use a switch or relay as the input contact.

Use a contact that is capable of operating with 5 V, 0.1 A (with a minimum signal input width of 100 ms).

Flush mounting models (H5S-□A2□/-□B2□)	⑨	⑩
Surface mounting models (H5S-□FA2□/-□FB2□)	⑥	⑦

One of the following functions can be assigned to the input.

- Time Counter/Total Counter Display
- Time Adjustment
- Manual Operation on Recovery from Power Failure
- Bank Switching

Note: Input must be selected using the “F2: Input selection” step of initial setting mode. For details, refer to *Using Advanced Functions* on page 23.

Nomenclature

Front Panel (with Cover Open)

Weekly Two-circuit Models

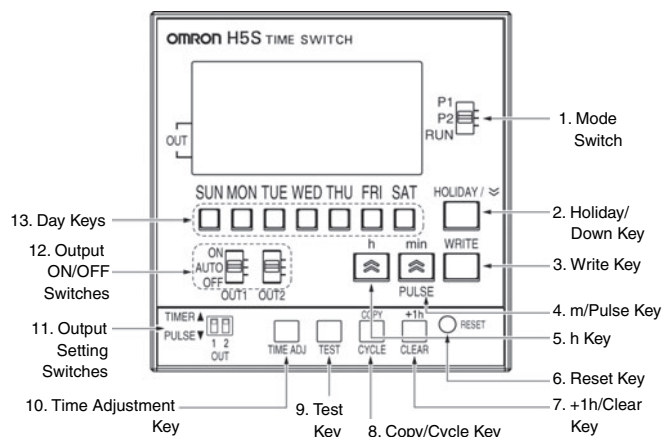

Yearly Two-circuit Models

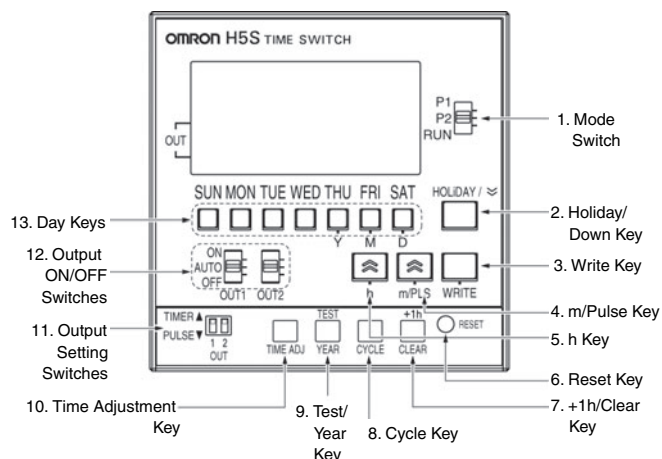

Yearly Four-circuit Models

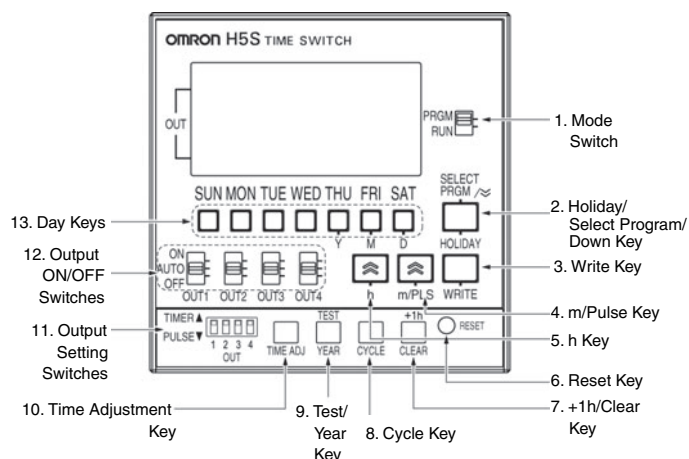

Key Operations

No.	Functions
1	Two-circuit Models P1: Circuit (output) 1 Setting mode P2: Circuit (output) 2 Setting mode RUN: RUN mode Four-circuit Models PRGM: Setting mode (allows use of the Select Program Key to set the circuit (output) number) RUN: RUN mode
2	Two-circuit Models In RUN mode, this key shifts the Time Switch to the Holiday Setting mode In Setting mode or Time Adjustment mode, this key decrements the value for the operation just completed. Four-circuit Models In RUN mode, this key shifts the Time Switch to the Holiday Setting mode. When selecting the output, this key is used to set the circuit (output) number. In Setting mode or Time Adjustment mode, this key decrements the value for the operation just completed.
3	Sets parameters.
4	Used to set the current time, ON/OFF time, or pulse width.
5	
6	Used to reset all parameters, including the current time.
7	In RUN mode, this key sets or cancels summer time (+1 h) In Setting mode, this key clears the parameter.
8	In RUN mode (weekly models only), this key shifts the Time Switch to the Day Override operation setting mode. In Setting mode, this key shifts the Time Switch to cyclic operation setting.
9	In RUN mode, this key shifts the Time Switch to the Program Check mode. In Setting mode (yearly models only), this key is used to set the yearly program.
10	This key shifts the Time Switch to the time adjustment mode.
11	TIMER: Executes a timer or cyclic operation. PULSE: Executes a pulse-output operation.
12	ON: Turns ON the output regardless of the setting. AUTO: Executes automatic operation as specified by these settings. OFF: Turns OFF the output regardless of the setting.
13	<ul style="list-style-type: none"> Used to set the current day, operating day, etc. Used to specify the date (yearly models only) In RUN mode, these keys are used to shift the Time Switch to the Checking the Settings mode.

Note: To enable operation according to the settings that you made, first make the settings and then set the Output ON/OFF Switch (12) to AUTO and the Mode Switch (1) to RUN.

Display

Weekly Two-circuit Models

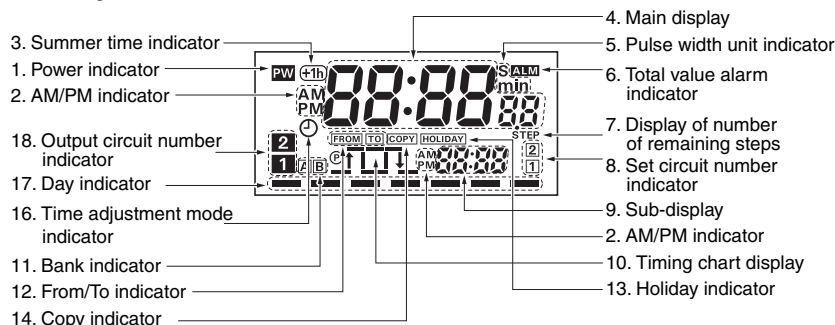

Yearly Two-circuit Models

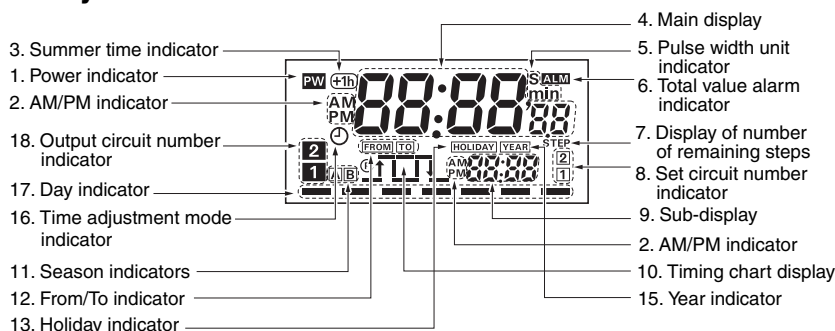

Yearly Four-circuit Models

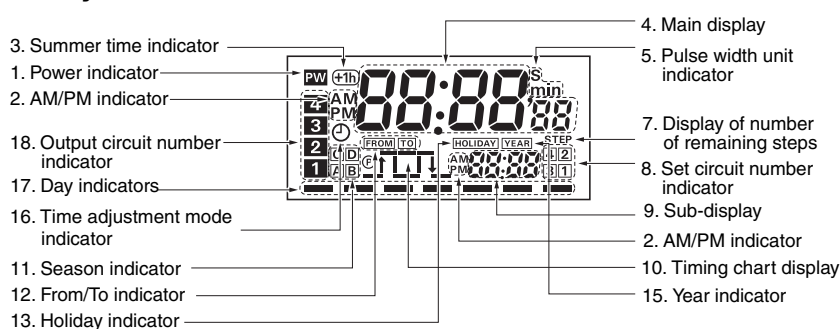

Display Description

No.	Function
1	Lights when power is supplied to the Time Switch.
2	When 12-hour display is selected, either AM or PM lights. (24-hour display is the default.)
3	Lights when summer time (+1 h) is activated.
4	Displays the current time and other values.
5	Displays the unit for the pulse width.
6	Lights when the total time or count value exceeds the alarm setting.
7	Displays the number of remaining steps for programming in setting mode.
8	Displays the number of the circuit (output) that has been set.
9	Displays the time for the next operation, the date (yearly models only), and other values.
10	Displays the next operation and other information in chart form.
11	Displays the bank name (weekly models) or season name (yearly models).
12	Lights when setting the ON/OFF time or when setting a day override operation.
13	Lit during the temporary holiday operation or when setting a temporary holiday.
14	Lit during the day override operation or when setting a day override operation.
15	Lit during setting a yearly program.
16	Flashes during the Time Adjustment mode.
17	Displays the current day or the day set for an operation.
18	Displays the number of the circuit (output) for which output is ON.

Dimensions

Note: All units are in millimeters unless otherwise indicated.

Digital Time Switch

Flush Mounting Model

H5S-□A□/-□B□

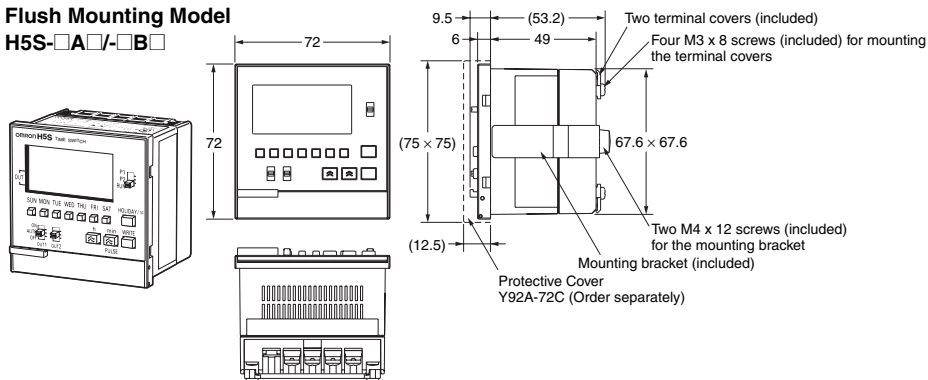

- Note: 1. The terminal screws are M3.5.
 2. This illustration shows a 2-circuit model. The 4-circuit model has the same dimensions.

Panel Cutout

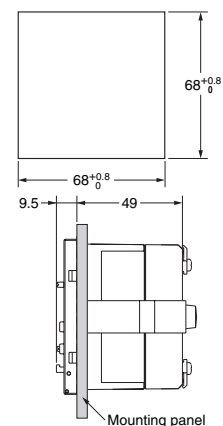

Note: Panel thickness: 1 to 5 mm

Surface Mounting Model

H5S-□FA□/-□FB□

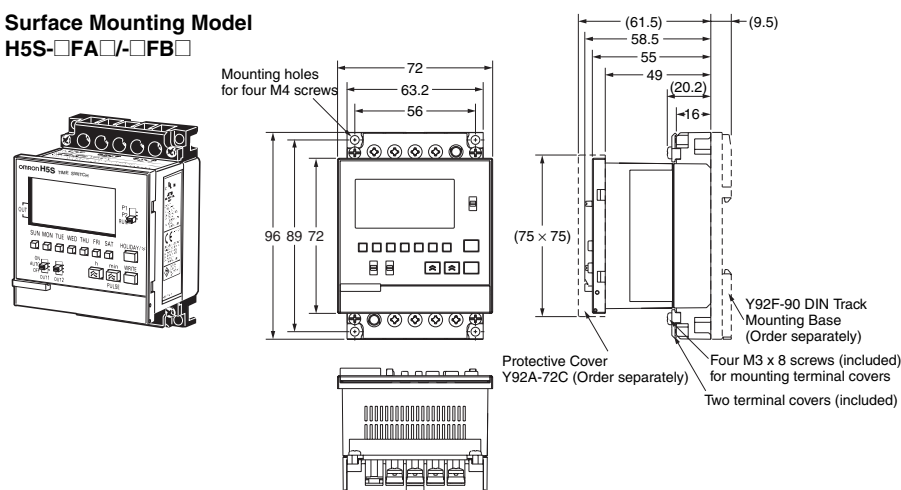

(Surface mounted) Mounting holes

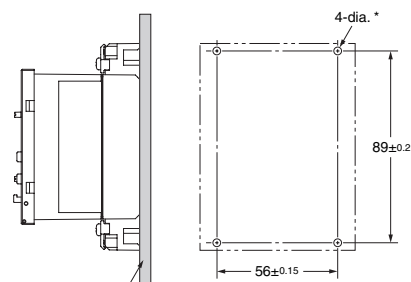

*Diameter of pilot holes for included M4 tapping screws (guideline)

Panel thickness t	0.8 to 1.2	1.6 to 4
Hole diameter	3.6	3.7

(With the large terminal cover (order separately) attached)

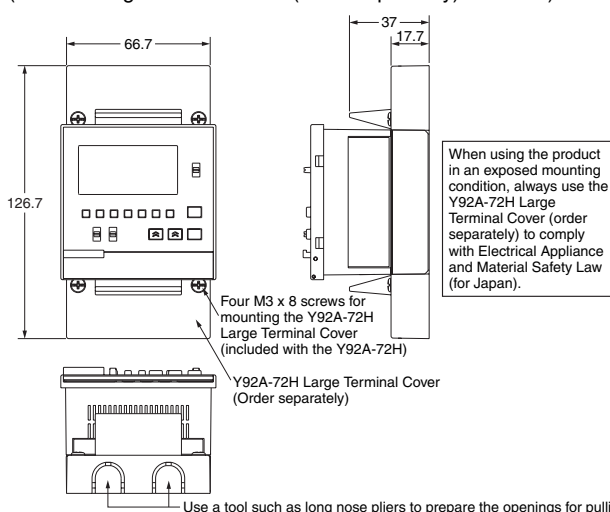

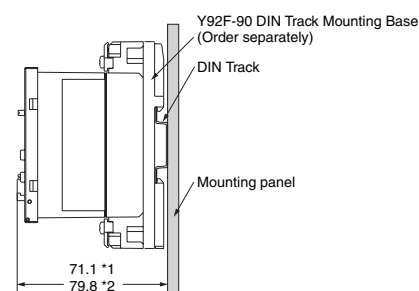

- Note: 1. The terminal screws are M3.5.
 2. This illustration shows a 2-circuit model. The 4-circuit model has the same dimensions.

(DIN track mounted)

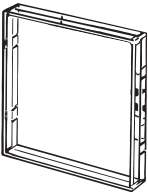

- Note: 1. Using a PFP-50N or PFP-100N Mounting Track.
 2. Using a PFP-100N2 Mounting Track.

■ Accessories (Order Separately)

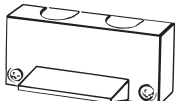
Protective Cover	DIN Track Mounting Base	Large Terminal Covers
<p>Y92A-72C</p> 	<p>Y92F-90</p>  <p>Note: The DIN Track Mounting Base can be used only with the surface mounting models (H5S-□FA□/-□FB□).</p>	<p>Y92A-72H (two per set)</p>  <p>Note: The Large Terminal Cover can be used only with the surface mounting models (H5S-□FA□/-□FB□).</p>

■ Track Mounting Accessories (Order Separately)

Mounting Track

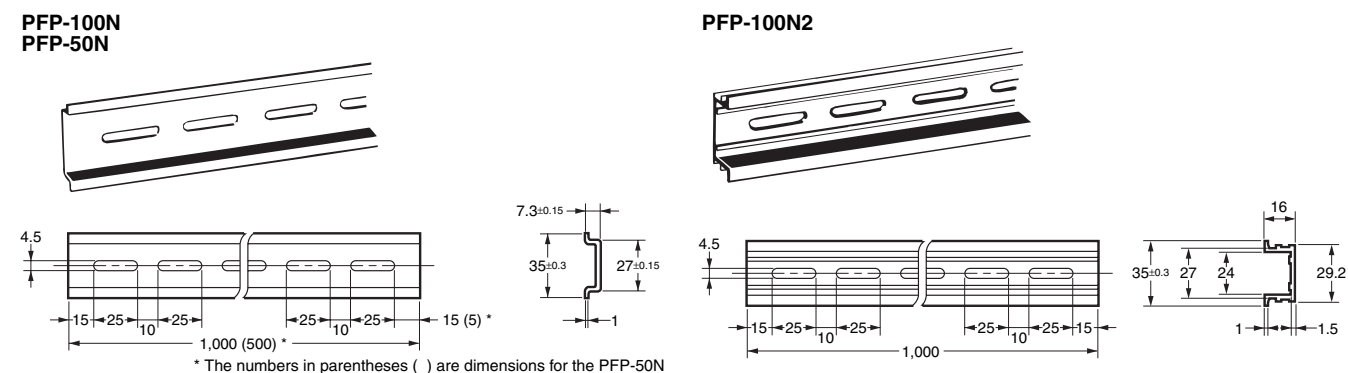

End Plate

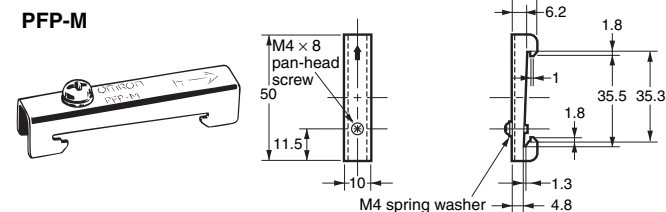

Spacer

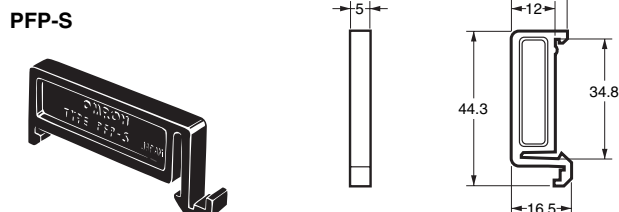

Safety Precautions

⚠ CAUTION

Minor injury by electric shock may occasionally occur. Do not touch any of the terminals while power is being supplied. Be sure to mount the terminal cover after wiring. When using a surface-mounting model in an exposed condition, always install the Y92A-72H terminal cover (separately purchased) to comply with Electrical Appliance and Material Safety Law (for Japan).



Minor injury due to explosion may occasionally occur. Do not use the product where subject to flammable or explosive gas.



Minor electric shock, fire or malfunction may occasionally occur. Never attempt to disassemble, modify, or repair the product or touch any of the internal parts.



Fire may occasionally occur. Tighten the terminal screws to the rated torque (from 0.98 to 1.17 N·m).



Unexpected operation may occasionally occur. Before changing times or other settings while power is being supplied, either turn OFF the power on the load side or set the output ON/OFF switch to OFF and confirm the safety of the system.



Minor electric shock, fire, or malfunction may occasionally occur. Do not allow metal fragments, lead wire scraps, or shavings from installation work to fall inside the Time Switch.



If the output relay is used beyond its life expectancy, its contacts may become fused or there may be a risk of burning. Use the product within its rated load and electrical life expectancy. The life expectancy of the output relay varies considerably according to its capacity and operating conditions.



Serious injury may occasionally occur due to fire or explosion of a battery, or leakage from a battery. Never attempt to short the positive and negative terminals, recharge, disassemble, deform by applying excessive pressure, or expose the battery to fire.



■ Precautions for Safe Use

Please comply strictly with the following instructions which are intended to ensure safe operation of the product.

1. Have the Time Switch installed only by qualified electrical workers.
2. Store the Time Switch within the specified ratings. If the Time Switch has been stored at temperatures of -10°C or lower, let it stand for three hours or longer at room temperature before turning ON the power supply.
3. Mounting the Time Switch side-by-side may reduce the life expectancies of internal components.
4. Use the Time Switch within the specified ratings for operating temperature and humidity.
5. Do not operate the Time Switch in any of the following locations.
 - Locations subject to sudden or extreme changes in temperature.
 - Locations where high humidity may result in condensation.
6. The Time Switch is not waterproof or oil resistant. Do not use it in locations subject to water or oil.
7. Do not use the Time Switch in locations subject to excessive dust, corrosive gas, or direct sunlight.
8. Install the Time Switch well away from any sources of excessive static electricity, such as pipes transporting molding materials, powders, or liquids.
9. Maintain voltage fluctuations in the power supply within the specified range.
10. Internal elements may be destroyed if a voltage outside the rated voltage is applied.
11. Be sure to wire the terminals correctly and use the correct polarity.

12. Separate equipment that produces input signals, input signal wiring, and the Time Switch from noise-generating sources and high-voltage lines containing noise.
13. Do not connect more than two crimp terminals to each Time Switch terminal.
14. Up to two wires of the same size and type can be inserted into a single terminals.
15. Use the specified wires for wiring.
Applicable wire: AWG 22 to AWG 14 (equal to a cross-sectional area of 0.326 to 2.081 mm²)
Solid wire or twisted wire
Material: Copper
16. Install a switch or circuit breaker that allows the operator to immediately turn OFF the power, and label it to clearly indicate its function.
17. Take adequate protective measures (such as a breaker, or fuse) for the power supply of the Time Switch.
18. When using heaters, be sure to use a thermal switch for the load circuit.
19. Always maintain the load current within specifications.
20. Use a switch, relay, or other contacts so that the rated power supply voltage will be reached within 0.1 s. If the power supply voltage is not reached quickly enough, the power source may fail to reset or the outputs may fail to operate correctly.
21. Use a switch, relay, or other contact to turn the power supply OFF instantaneously. Outputs may malfunction and memory errors may occur if the power supply voltage is decreased gradually.
22. The Time Switch utilizes a transformerless power supply. Do not touch the input terminal while power is being supplied; touching live terminals may result in electric shock.
23. Use the Time Switch within the specified ratings for vibration and shock.
24. Use a commercial power supply when using AC power supply voltage input.
Although some inverters specify their output frequency as 50/60 Hz, smoke or burning may occur from a rise in internal temperature. Do not use inverter output as the power supply.
25. Do not leave the Time Switch for long periods at a high temperature with output current in the ON state. Doing so may result in the premature deterioration of internal components (e.g., electrolytic capacitors).
26. Do not use organic solvents (such as paint thinner or benzene), strong alkaline, or strong acids to clean the case because they will damage the external finish.
27. None of the Time Switch components are user-replaceable, including the battery.
28. Use a tool such as long nose pliers to prepare the openings for pulling wires out of the optional Y92A-72H Large Terminal Cover. Attempts to form an opening by hand may result in injury.

■ Precautions for Correct Use

1. When the power is turned ON, an inrush current will flow for a short time (AC: Approx. 2.5 A (0.3 ms), DC: Approx. 1.1 A (3 ms)). Depending on the power supply capacity, operation may not start. Be sure to use a power supply with a sufficient capacity.
2. Inrush current generated by turning ON or OFF the power supply may deteriorate contacts on the power supply circuit. Use to turn ON or OFF devices with a rated current of 10 A min.
3. The timer functions and set program are backed up by a battery. If the life of the battery expires, the display will become irregular or may fail to function. The battery cannot be replaced by the user. Contact your OMRON representative.

EN/IEC Standards

- The insulation system between the power supply circuit and input-output terminals provides basic insulation. Therefore connect the output terminals only to circuits without exposed conductive parts. If a connection to a Safety Extra Low Voltage (SELV) circuit is desired, supplementary insulation must be provided.
- Use crimp type cable lug terminals with insulating sleeves for wiring.
- Be sure to mount a surface-mounting model (H5S-□FA□/-□FB□) in an enclosure.

- The relationship between load current and ambient air temperature is shown by the range below for 2-circuit models.

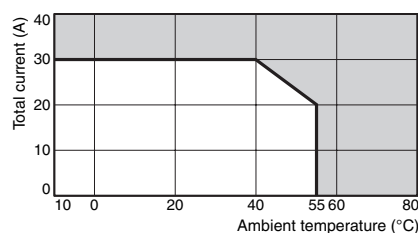

If wires with a temperature rating of 105 °C or higher are used, refer to the derating curve in *Specifications* on page 3.

- Control system: Electronic
- Types of automatic operation: Weekly models - Type 1 BSTU
Yearly models - Type 2 BSTU
- Protective class: Class 0
- Rated impulse withstand voltage: 2,500 V AC
- Ball-pressure test temperature (enclosure material): 125°C

Basic Use

Prior to Using

Before setting the parameters necessary for each operation, the operation of each circuit (output) must be determined. Begin by setting initial setting mode as required.

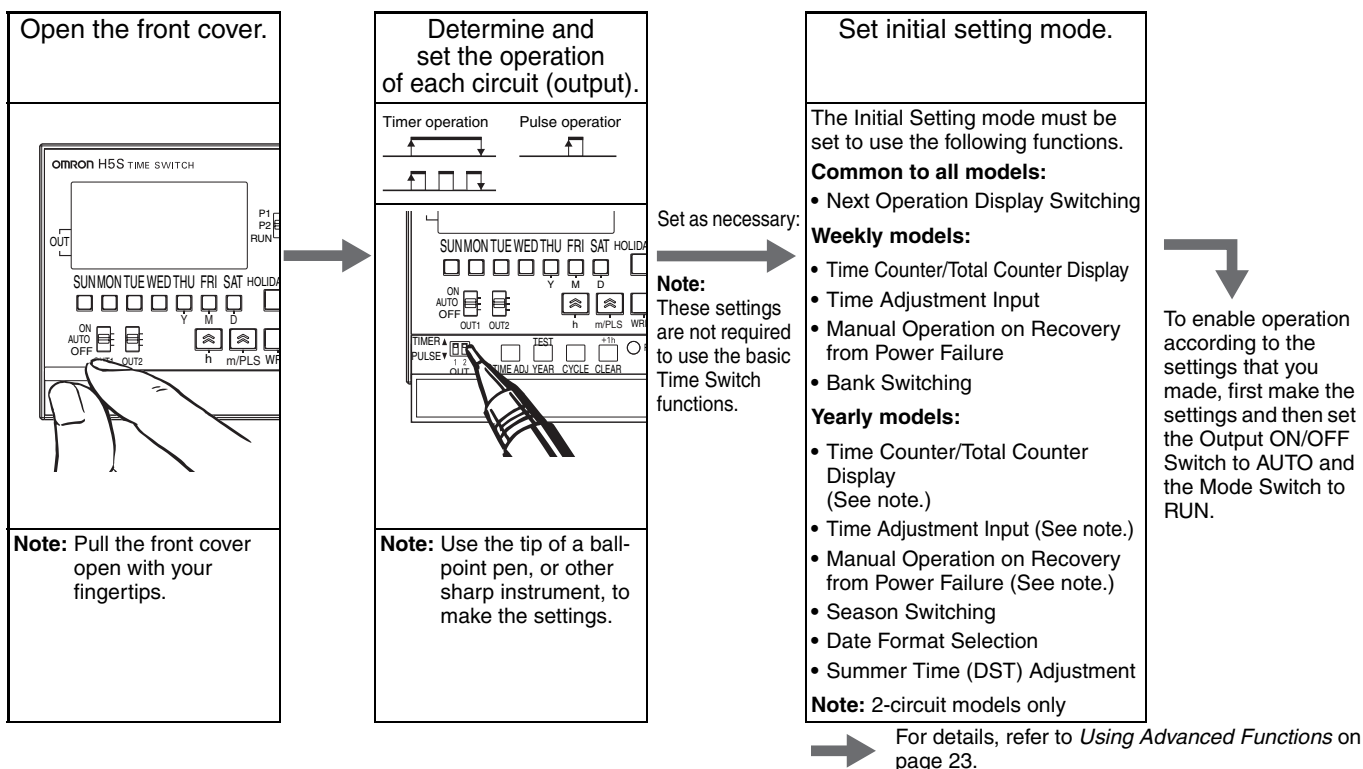

Time Adjustment (Weekly Models)

Weekly, 2 Circuits

Example: Set the current time to Saturday 17:28.

1. Set the Mode Switch to RUN.



Shaded portion indicates blinking of the indicator.

2. Press **TIME ADJ** for 2 s or more. The ☉ symbol flashes.



3. Press **SAT**. (The bar (—) mark at the Saturday position will turn ON.)

Set the time with **h** and **m**. *

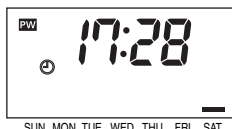

4. Press **WRITE** to enter the setting, and the Time Switch will start from 0 second.

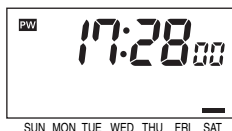

- * Holding down the **h** and **m** Keys rapidly advances the value. Pressing **☺** decrements the value of the key that was last pressed.

Note:

- When first turned ON or after a reset, the time adjustment display appears on the screen. Adjust the time by following steps 3 and 4.
- If **TIME ADJ** is pressed again before pressing **WRITE**, the setting is cancelled. (The setting is not revised.)

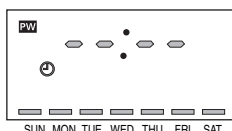

Time Adjustment (Yearly Models)

Yearly, 2 Circuits Yearly, 4 Circuits

Example: Set the current time to 17:28 on August 15, 2006.

1. Set the Mode Switch to RUN.

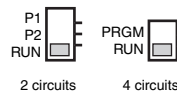

Shaded portion indicates blinking of the indicator.

2. Press **TIME ADJ** for 2 s or more. The ☉ symbol flashes.



3. Specify the date by pressing **Y**, **M** and **D**. *

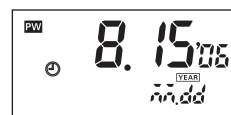

4. Press **WRITE**. Set the time with **h** and **m**. *

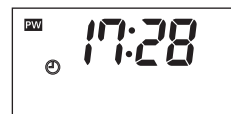

5. Press **WRITE** to enter the settings, and the Time Switch will start from 0 second.



- * Holding down the **h** and **m** Keys rapidly advances the value. Pressing **☺** decrements the value of the key that was last pressed.

Note:

- When first turned ON or after a reset, the time adjustment display appears on the screen. Adjust the time by following steps 3 through 5.
- If **TIME ADJ** is pressed again before pressing **WRITE**, the setting is cancelled. (The setting is not revised.)

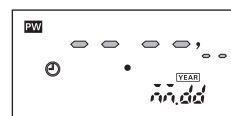

Ordinary Timer Operation

Weekly, 2 Circuits | Yearly, 2 Circuits | Yearly, 4 Circuits

Example: ON at 8:30 and OFF at 17:15 on Monday through Friday.

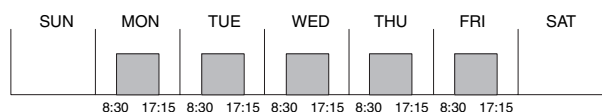

1. Set the Mode Switch to P1 or P2. *1
(The Time Switch enters program setting mode.)
→For 4-circuit models, refer to page 18.

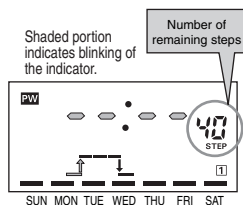
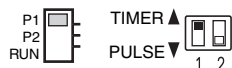

2. Press the Day Keys to turn ON the bars (—) at the positions of Monday through Friday.
Set the ON time with [h] and [m]. *2



3. Press [WRITE].
Set the OFF time with [h] and [m]. *2

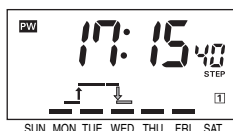

4. Press [WRITE] to enter the settings.

*1 If one or more programs have already been set, the display starts showing the set programs.

To add another program, press [WRITE] repeatedly until “-:-:-” is displayed.

*2 Holding down the [h] and [m] Keys rapidly advances the value.
Pressing [↵] decrements the value of the key that was last pressed.

Note:

- If multiple settings are required, repeat steps 2 through 4.
- Both the ON and OFF times must be set.
- All of the weekly programs for the selected circuit (output) can be checked by pressing [WRITE] in program setting mode.
- When the Mode Switch is set to P1 or P2 (to PRGM for 4-circuit models), the Time Switch stops automatic operation. To forcibly turn ON or OFF the output, use the Output ON/OFF Switches.
- The set data will be cleared if the Output Setting Switch is moved between the TIMER and PULSE positions after the data has been set.

Multiple-day Operation 1

Weekly, 2 Circuits | Yearly, 2 Circuits | Yearly, 4 Circuits

Example: ON continuously from 8:30 on Monday to 17:15 on Friday.

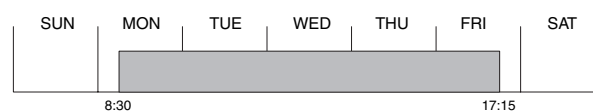

1. Set the Mode Switch to P1 or P2.*1
(The Time Switch enters program setting mode.)
→For 4-circuit models, refer to page 18.

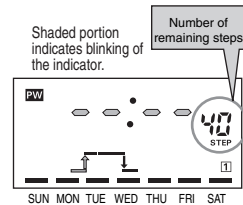
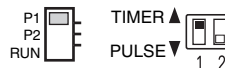

2. Press the Day Keys to turn ON the bar (—) at the Monday position. Set the ON time with [h] and [m]. *2

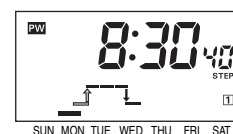

3. Press [WRITE].
Press [MON] to flash the bar (—) at all day positions and press [FRI] to turn ON the bar (—) at the Friday position.

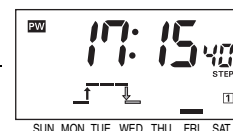

Set the OFF time with [h] and [m]. *2

4. Press [WRITE] to enter the settings.

*1 If one or more programs have already been set, the display starts showing the set programs.

To add another program, press [WRITE] repeatedly until “-:-:-” is displayed.

*2 Holding down the [h] and [m] Keys rapidly advances the value.
Pressing [↵] decrements the value of the key that was last pressed.

Multiple-day Operation 2

Weekly, 2 Circuits Yearly, 2 Circuits Yearly, 4 Circuits

Example: ON at 22:00 from Monday through Friday and OFF at 8:00 each following morning.

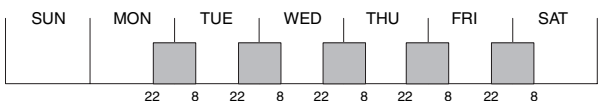

1. Set the Mode Switch to P1 or P2. *1
(The Time Switch enters program setting mode.)
→For 4-circuit models, refer to page 18.

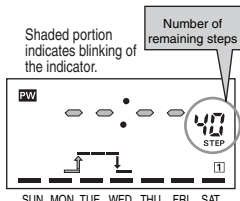
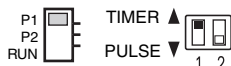

2. Press the Day Keys to turn ON the bar (—) at the positions of Monday through Friday.
Set the ON time with [h] and [m]. *2



3. Press [WRITE].

Press [MON] to turn OFF the bar (—) at the Monday position and press [SAT] to turn ON the bar (—) at the Friday position.

Set the OFF time with [h] and [m]. *2

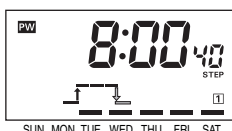

4. Press [WRITE] to enter the settings.

*1 If one or more programs have already been set, the display starts showing the set programs.

To add another program, press [WRITE] repeatedly until "--:--" is displayed.

*2 Holding down the [h] and [m] Keys rapidly advances the value.

Pressing [] decrements the value of the key that was last pressed.

Pulse-output Operation

Weekly, 2 Circuits Yearly, 2 Circuits Yearly, 4 Circuits

Example: ON for 30 seconds at 8:25 am from Monday through Saturday.

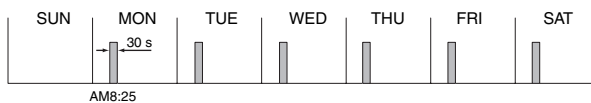

1. Set the Mode Switch to P1 or P2.*1
(The Time Switch enters program setting mode.)
→For 4-circuit models, refer to page 18.

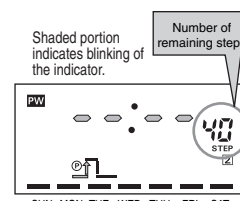
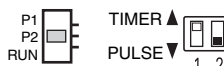

2. Press the Day Keys to turn ON the bars (—) at the positions of Monday through Saturday. Set the ON time with [h] and [m]. *2

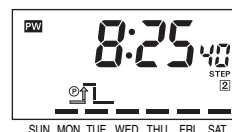

3. Press [WRITE].

Set the pulse width with [PLS]. *2
The displayed pulse width changes by pressing this key in the following order.
1s→2s...→59s→1m...→59m→60m→1s

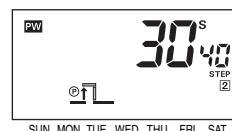

4. Press [WRITE] to enter the settings.

*1 If one or more programs have already been set, the display starts showing the set programs.

To add another program, press [WRITE] repeatedly until "--:--" is displayed.

*2 Holding down the [h] and [m] Keys rapidly advances the value.

Pressing [] decrements the value of the key that was last pressed.

Note:

- If multiple settings are required, repeat steps 2 through 4.
- Both the ON time and pulse width must be set.
- All of the weekly programs for the selected circuit (output) can be checked by pressing [WRITE] in program setting mode.
- When the Mode Switch is set to P1 or P2 (to PRGM for the 4-circuit model), the Time Switch stops automatic operation. To forcibly turn ON or OFF the output, use the Output ON/OFF switches.
- The set data will be cleared if the Output setting switch is moved between the TIMER and PULSE positions after the data has been set.

Cyclic Operation

Weekly, 2 Circuits Yearly, 2 Circuits Yearly, 4 Circuits

Example: ON for 5 minutes and OFF for 1 hour 55 minutes repeatedly from 8:00 to 19:00 on Sunday.

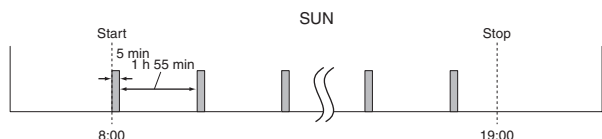

1. Set the Mode Switch to P1 or P2. *1
(The Time Switch enters program setting mode.)
→For 4-circuit models, refer to page 18.

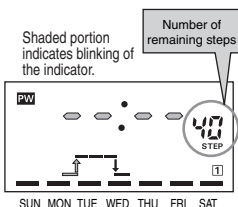
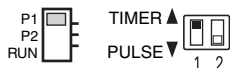

2. Press **CYCLE**.
(The Time Switch enters cyclic program setting mode.)

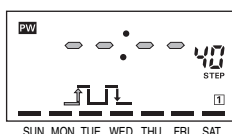

3. Press the Day Keys to turn ON the bar (—) at the Sunday position.
Set the start time to 8:00 with **h** and **m**. *2

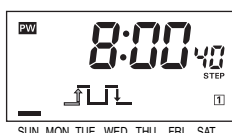

4. Press **WRITE**.
Set the stop time to 19:00 with **h** and **m**. *2

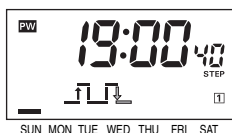

5. Press **WRITE**.
Set the ON time period with **h** and **m**. *2

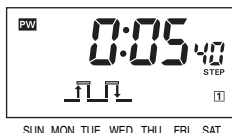

6. Press **WRITE**.
Set the OFF time period with **h** and **m**. *2

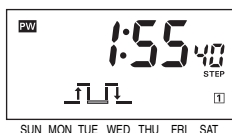

7. Press **WRITE** to enter the settings.

*1 If one or more programs have already been set, the display starts showing the set programs.

To add another program, press **WRITE** repeatedly until "--:--" is displayed.

*2 Holding down the **h** and **m** Keys rapidly advances the value.

Pressing **⊖** decrements the value of the key that was last pressed.

The ON time width and OFF time width can each be set to between 1 minute and 11 hours 59 minutes.

Note:

- If multiple settings are required, repeat steps 2 through 7.
- All the start/stop times, and ON/OFF time periods must be set.
- All of the weekly programs for the selected circuit (output) can be checked by pressing **WRITE** in program setting mode.
- When the Mode Switch is set to P1 or P2 (to PRGM for 4-circuit models), the Time Switch stops automatic operation. To forcibly turn ON or OFF the output, use the Output ON/OFF Switches.
- Set cyclic operation so as not to overlap other operations in individual circuits.
- The set data will be cleared if the Output Setting Switch is moved between the TIMER and PULSE positions after the data has been set.

Clearing the Settings

Weekly, 2 Circuits Yearly, 2 Circuits Yearly, 4 Circuits

Partial clearing

1. Set the Mode Switch to P1 or P2 and select the setting to be cleared. Shaded portion indicates blinking of the indicator.

2. Press **CLEAR** briefly.

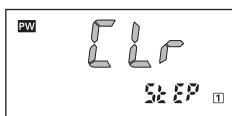

3. Press **WRITE** to clear the setting. *

Clearing all the settings in an entire circuit

1. Set the Mode Switch to the position for the circuit whose settings are to be cleared. Shaded portion indicates blinking of the indicator.

2. Press and hold **CLEAR** for 3 s or more.

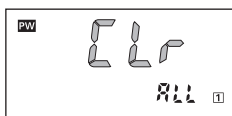

3. Press **WRITE** to clear all the settings of the circuit. *

* The clearing operation can be cancelled by pressing **CLEAR** while **ALL** is displayed.

Programming for 4-circuit models

Yearly, 4 Circuits

The following shows how to program (select the output circuit number) for 4-circuit models.

1. Set the Mode Switch to PRGM. (The Time Switch enters program setting mode.)



2. Select an output circuit with **SELECT PRGM**. Pressing the key changes the set circuit number displayed in the lower right corner of the LCD.

Shaded portion indicates blinking of the indicator.

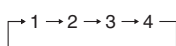
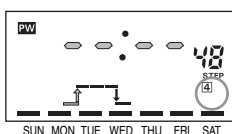

The rest of the procedure is the same as for 2-circuit models.

Note: The circuit number cannot be changed during the course of setting.

About Yearly Programs

Yearly, 2 Circuits Yearly, 4 Circuits

Yearly programs in addition to ordinary weekly programs can be set for 2- and 4-circuit yearly models.

Example: Extend ordinary weekly operation from 18:00 to 22:15 on March 25 only.

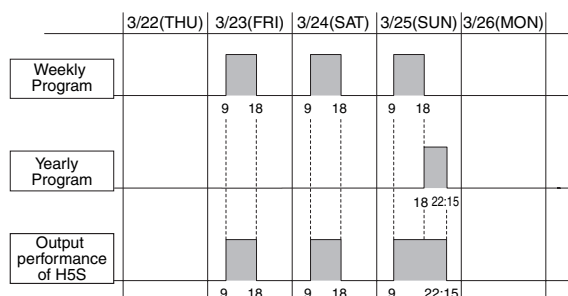

Note: 1. This example combines the following programs. For details on yearly programming, refer to page 19.
Weekly program
 Friday, Saturday, and Sunday: 9:00 (ON time), 18:00 (OFF time)

Yearly program
 March 25: 18:00 (ON time), 22:15 (OFF time)

2. For details on automatically switching the weekly program depending on the season, refer to page 24.

Example: ON continuously from 18:00 on March 25, 2006, to 12:00 on April 9, 2006.

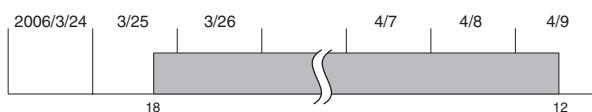

To set multiple-day operation for a yearly program, two yearly programs must be set as shown in the following example.

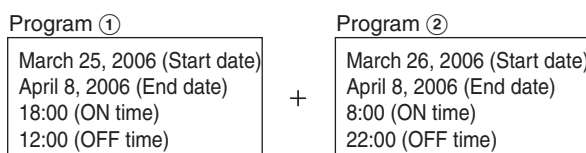

Note: Do not enter a weekly program.

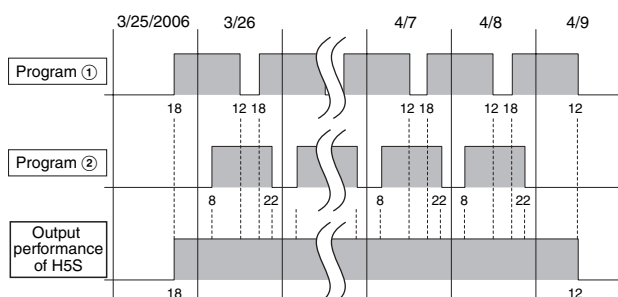

Yearly Timer Operation

Yearly, 2 Circuits Yearly, 4 Circuits

Example: ON at 18:00 and OFF at 22:15 on March 25 every year.

Set the program in the following order.

↓	Day period	March 25, 2006 (Start date)
	Time period	March 25, 2006 (End date)
		18:00 (ON time)
		22:15 (OFF time)

- Set the Mode Switch to P1 or P2.
→For 4-circuit models, refer to page 18.

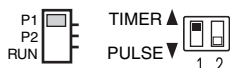

Shaded portion indicates blinking of the indicator.

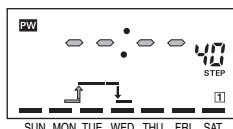

- Press **[YEAR]** for 1 s or more. (The Time Switch enters yearly program setting mode. *1)

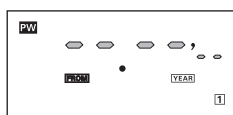

- Specify the start date using **[Y]**, **[m]** and **[D]**. *2
The year can be set from the current year to the next two years as shown in the example. If the year is set to "--", the operation performs every year.
<Example>
If the current year is 2006, the displayed year changes as follows.
-- → 06 → 07 → 08 → -- → 06 →



- Press **[WRITE]**.
Specify the end date using **[Y]**, **[m]** and **[D]**. *2
If the starting year has been set to "--", the ending year cannot be set.



- Press **[WRITE]**.
Set the ON time with **[h]** and **[m]**. *2

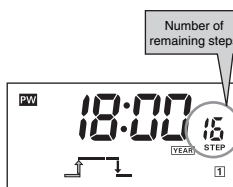

- Press **[WRITE]**.
Set the OFF time with **[h]** and **[m]**. *2

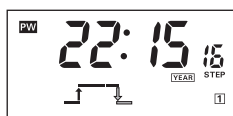

- Press **[WRITE]** to enter the settings.

*1 If one or more programs have already been set, the display starts showing the set programs.

To add another program, press **[WRITE]** repeatedly until "--:--" is displayed.
*2 Holding down the date- or time-setting keys rapidly advances the value.

Pressing **[<=>]** decrements the value of the key that was last pressed.

Note:

- Yearly programs are added to weekly programs.
- All the start/end dates and ON/OFF times must be set. the maximum number of yearly timer operations that can be set is four for each output circuit.
- If multiple settings are required, repeat steps 3 through 7.
- All of the yearly programs for the selected circuit (output) can be checked by pressing **[WRITE]** in yearly program setting mode.
- The set data will be cleared if the Output Setting Switch is moved between the TIMER and PULSE positions after the data has been set.

Yearly Pulse-output Operation

Yearly, 2 Circuits Yearly, 4 Circuits

Example: To produce output for 2 minutes at 18:00 from March 25 to April 9.

Set the program in the following order.

↓	Day period	March 25, 2006 (Start date)
	Time period	April 9, 2006 (End date)
		18:00 (ON time)
		2 minutes (Pulse width)

Shaded portion indicates blinking of the indicator.

- Set the Mode Switch to P1 or P2.
→For 4-circuit models, refer to page 18.

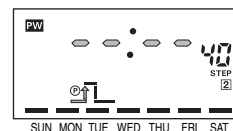
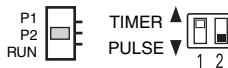

- Press **[YEAR]** for 1 s or more. (The Time Switch enters yearly program setting mode. *1)

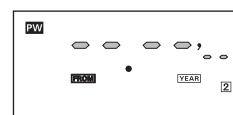

- Specify the start date using **[Y]**, **[m]** and **[D]**. *2
The year can be set from the current year to the next two years as shown in the example. If the year is set to "--", the operation performs every year.
<Example>
If the current year is 2006, the displayed year changes as follows.
-- → 06 → 07 → 08 → -- → 06 →



- Press **[WRITE]**.
Specify the end date using **[Y]**, **[m]** and **[D]**. *2
If the starting year has been set to "--", the ending year cannot be set.



- Press **[WRITE]**.
Set the ON time with **[h]** and **[m]**. *2

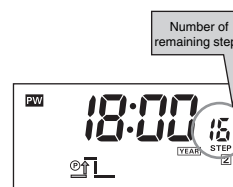

- Press **[WRITE]**.
Set the pulse width with **[PLS]**.
The displayed pulse width changes by pressing this key in the following order.
1 s → 2 s → ... 59 s → 1 m → ... 59 m → 60 m → 1 s

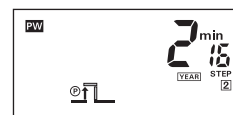

- Press **[WRITE]** to enter the settings.

*1 If one or more programs have already been set, the display starts showing the set programs.

To add another program, press **[WRITE]** repeatedly until "--:--" is displayed.
*2 Holding down the date- or time-setting keys rapidly advances the value.

Pressing **[<=>]** decrements the value of the key that was last pressed.

Note:

- Yearly programs are added to weekly programs.
- All the start/end dates, ON time, and pulse width must be set. The maximum number of yearly pulse output operations that can be set is four for each output circuit.
- If multiple settings are required, repeat steps 3 through 7.
- All of the yearly programs for the selected circuit (output) can be checked by pressing **[WRITE]** in yearly program setting mode.
- The set data will be cleared if the Output Setting Switch is moved between the TIMER and PULSE positions after the data has been set.

Convenient Functions

Setting Temporary Holidays (Weekly)

Weekly, 2 Circuits

Temporary holidays (non-operating days) can be easily set. Because the setting is automatically cleared after the set holiday has passed, temporary holidays are easily set without changing other settings, including those of the Output ON/OFF Switches.

Example: Friday and Saturday in the current week are set as holidays (non-operating days). The Time Switch then operates according to the ordinary (previous) settings from the following week onward.

Shaded portion indicates blinking of the indicator.

1. Press **[HOLIDAY]** for 2 s or more in RUN mode. (The Time Switch enters holiday setting mode.)

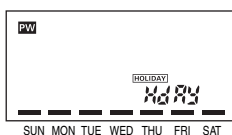

2. Turn OFF the bars (—) at the positions of the days to be set as holidays.
Bar ON: Operating day
Bar OFF: Holiday

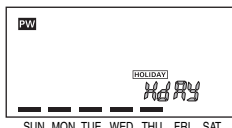

3. Press **[WRITE]** to enter the setting. After "HdRy" is displayed for approximately 1 s, the Time Switch returns to RUN mode.

Note:

- Any day in the 7-day period starting from the current day can be set as a holiday. The setting is automatically cleared after the set holiday has passed.
- All ON operations are cancelled on the holiday.
- The set holidays are valid for all the output circuits.
- You must be in RUN mode to enter to holiday setting mode.
- If the current day of the week is changed, the holiday settings will be cleared.
- Press **[HOLIDAY]** for 2 s in holiday setting mode to return to RUN mode. If you do nothing for 30 s, the Time Switch will automatically return to RUN mode.

Setting Temporary Holidays (Yearly)

Yearly, 2 Circuits Yearly, 4 Circuits

Temporary* holidays (non-operating days) can be set simply by specifying dates. The holidays will be OFF in both the weekly and yearly programs. Because the setting is automatically cleared after the set holiday has passed, temporary holidays are easily set without changing other settings, including those of the Output ON/OFF Switches.

* Annual holidays can also be set.

Example: The days from April 29 to May 7 in 2006 are set as holidays (non-operating days). The Time Switch then operates according to the ordinary (previous) settings from the following year onward.

Shaded portion indicates blinking of the indicator.

1. Press **[HOLIDAY]** for 2 s or more in RUN mode. *1 (The Time Switch enters holiday setting mode.)

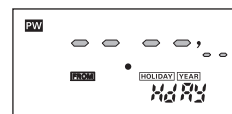

2. Specify the start date of holidays using **[Y]**, **[M]** and **[D]**. *2
The year is displayed in the following order by pressing **[Y]**. (The year can be set from the current year to the next two years.)



<Example> If the current year is 2006, the displayed year changes as follows.
06→07→08→--→06→

If the year is set to --, the holiday setting is executed every year.

3. Press **[WRITE]**.
In the same manner, specify the end date of holidays using **[Y]**, **[M]** and **[D]**. *2
If the starting year has been set to "--", the ending year cannot be set.



4. Press **[WRITE]** to enter the settings.

5. Press **[HOLIDAY]** for 2 s or more to return to RUN mode.

*1 If one or more programs have already been set, the display starts showing the set programs.

To add another program, press **[WRITE]** repeatedly until "--" is displayed.

*2 Holding down the date-setting keys rapidly advances the value.

Pressing **[<]** decrements the value of the key that was last pressed.

Note:

- Any date between the current date and December 31 in the year after the following year can be specified as a holiday.
- The setting is automatically cleared after the set holiday has passed (unless the year is set to --).
- Repeat steps 2 to 4 to make other settings.
- Both the start and end dates of holidays must be set. The maximum number of holidays that can be set is 16.
- You must be in RUN mode to enter to holiday setting mode.
- If the current date is changed, the holiday settings will be cleared.
- When you specify the year, be sure to set the end date so that it is after the start date.
- Press **[HOLIDAY]** for 2 s in holiday setting mode to return to RUN mode. If you do nothing for 30 s, the Time Switch will automatically return to RUN mode.
- All ON operations are cancelled on the holiday.
- The set holidays are valid for all the output circuits.

Program Check Function

Weekly, 2 Circuits **Yearly, 2 Circuits** **Yearly, 4 Circuits**

The days and times when output is set to turn ON and OFF over the course of one week can be displayed in the sequence in which the Time Switch is to operate.

However, for timer operation, only the OFF time will be displayed for the programming that is currently being executed. The ON time will not be displayed.

For a program that is not being executed, all of the programming for circuit 1 will be displayed and then the programming for circuit 2 and later will be displayed.

Shaded portion indicates blinking of the indicator.

1. Press **TEST** for 2 s or more in RUN mode. ("E5t" flashes and the day and time of the next change in output state are displayed.)

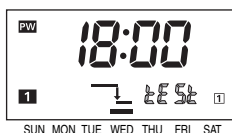

2. Press **WRITE**.
The display shows the time of the next change in output state.
Each time **WRITE** is pressed, the display shows the days and times for one week.

Note: A yearly program cannot be tested.

Checking the Settings

Weekly, 2 Circuits **Yearly, 2 Circuits** **Yearly, 4 Circuits**

The program can be checked for one week from the current day. Change to the setting mode to check the year program past one week.

Shaded portion indicates blinking of the indicator.

1. Press one of the Day Keys for 2 s or more in RUN mode to check settings for the day. ("HEt" flashes and the time of the first ON time is displayed.)

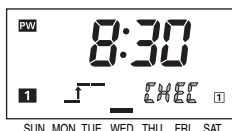

2. Press **WRITE**.
The display shows the time of the next change in output state.

Day Override Operation

Weekly, 2 Circuits

Operation for one day can be temporarily (for only one week) executed on another day.

Example: The operation set for Sunday is executed this Saturday. The Time Switch performs the ordinary operation (according to the previous settings) from next Saturday onward.

Shaded portion indicates blinking of the indicator.

1. Press **COPY** for 2 s or more in RUN mode. (The Time Switch enters day override operation setting mode.)

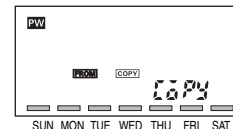

2. Turn ON the bar (—) at the position of the day for which the set operation is to be executed on another day. ("OPY" will flash.)

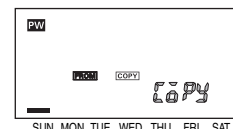

3. Press **WRITE** to select the day on which the operation is to be executed.

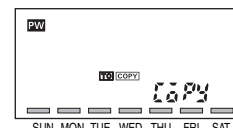

4. Turn ON the bar (—) at the position of the day. More than one day can be selected.



5. Press **WRITE** to enter the setting.

Note:

- Any day in the 7-day period starting from the current day can be set as a day on which another day's operation is to be executed. The setting is automatically cleared after the day has passed.
- All ON operations are executed on another day.
- The day override operation settings are valid for all the output circuits.

Manual Summer Time (DST)

Adjustment

Weekly, 2 Circuits **Yearly, 2 Circuits** **Yearly, 4 Circuits**

Each time **+1h** is pressed for 2 s or more in RUN mode, the current time switches between the current time and the current time +1 hour.

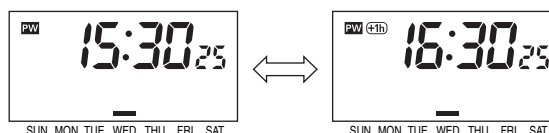

Note: With Yearly models, the current time can also be automatically switched to DST. For details, refer to functions F6 and F7 on page 25.

Switching between 12-hour and 24-hour display

Weekly, 2 Circuits Yearly, 2 Circuits Yearly, 4 Circuits

Each time **[h]** is pressed for 2 s or more in RUN mode, the current time switches between 12-hour (AM/PM) and 24-hour display.

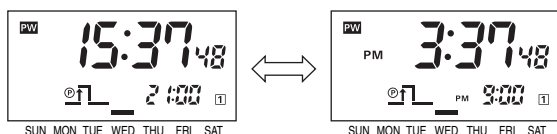

Display Switching

Each time **[m]** is pressed for 2 s or more in RUN mode, the displayed content switches as shown below.

Weekly, 2 Circuits

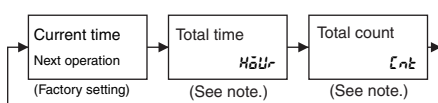

Note: Displays only when Input selection (see function F2 on page 23) is set to **k&Lk**.

Yearly, 2 Circuits

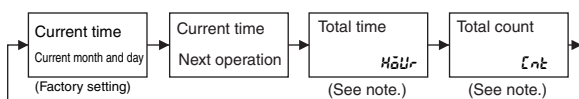

Note: Displays only when Input selection (see function F2 on page 23) is set to **k&Lk**.

Yearly, 4 Circuits

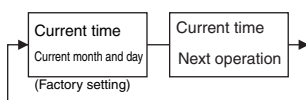

Override and Automatic Return Operation

Weekly, 2 Circuits Yearly, 2 Circuits Yearly, 4 Circuits

Helps to cope with sudden schedule changes without having to revise the existing program. This function allows ON/OFF states that were forcibly set using the Output ON/OFF Switch to be maintained until the next ON/OFF time.

Turn output OFF while maintaining AUTO operation

1. Change the setting of the Output ON/OFF Switch from AUTO to OFF.
2. Return the Output ON/OFF Switch from OFF to AUTO while pressing **[WRITE]**. (Output remains in the OFF state.)
3. The regular operation will be performed from the next ON time.



Turn output ON while maintaining AUTO operation

1. Change the setting of the Output ON/OFF Switch from AUTO to ON.
2. Return the Output ON/OFF Switch from ON to AUTO with **[WRITE]** pressed. (Output remains in the ON state.)
3. The regular operation will be performed from the next OFF time.



Using Advanced Functions

About Advanced Functions

Set the advanced functions as required to perform more advanced operation. Outlines of the advanced functions are provided on the following pages.

Refer to the *Instruction Manual* enclosed with the H5S for details.

Initial Setting Mode

Weekly, 2 Circuits **Yearly, 2 Circuits** **Yearly, 4 Circuits**

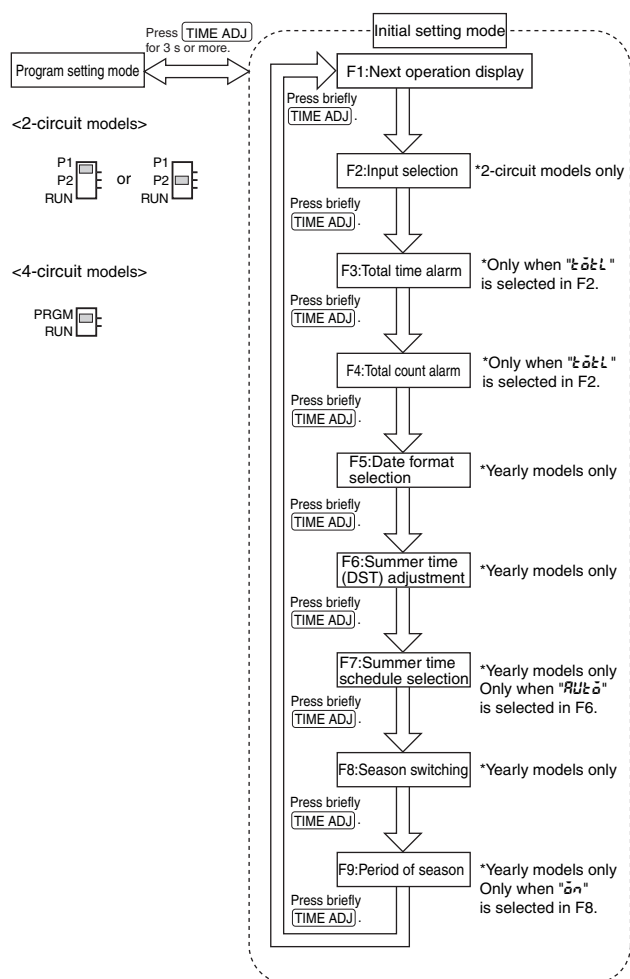

Time Counter/Total Counter Display (F2, F3, F4)

Yearly, 2 Circuits **Yearly, 2 Circuits**

This function displays the total elapsed time and total input count for an external input.

The alarm indicator can also be displayed if an alarm value has been set.

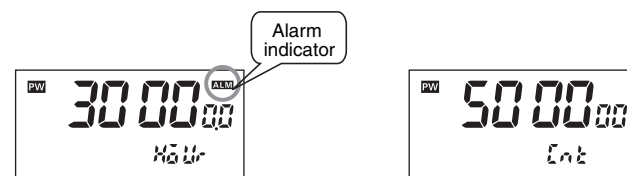

Time counter display (Example shows display when the total elapsed time is 30,000 hours.)

Total counter display (Example shows display when the total input count is 500,000.)

Note: For display details, refer to *Display Switching* on page 22.

<Resetting the total time and count>

1. Press **CLEAR** for 3 s or more while the total time or count is displayed.
 2. Press **WRITE** to reset the total time and total count
- * The resetting is cancelled by pressing **CLEAR** again while "ELr" is flashing.

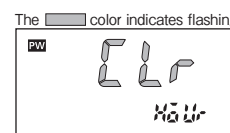

Input selection (F2)

- Set Input selection (F2) in initial setting mode to Time Counter/Total Counter.

Shaded portion indicates blinking of the indicator.

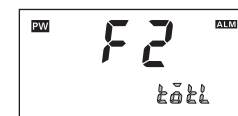

1. Press **h** or **m** to change the display to tōtL.
2. Press **WRITE** to enter the setting.

Alarm for time counter (F3)

Shaded portion indicates blinking of the indicator.



1. The display will automatically change to the alarm setting screen 2 s after switching to F3.
Press the **h** or **m**.
h Key: Increments in units of 1,000 h*
m Key: Increments in units of 10 h*
2. Press **WRITE** to enter the setting.
* Pressing **↓** decrements the value of the key that was last pressed.

Note: The default setting is 0 (no alarm display).

Alarm for total counter (F4)

Shaded portion indicates blinking of the indicator.



1. The display will automatically change to the alarm setting screen 2 s after switching to F4.
Press the **h** or **m**.
h Key: Increments in units of 10,000*
m Key: Increments in units of 100*
2. Press **WRITE** to enter the setting.
* Pressing **↓** decrements the value of the key that was last pressed.

Note: The default setting is 0 (no alarm display).

Time Adjustment Input Function (F2)

Weekly, 2 Circuits Yearly, 2 Circuits

The time can be set to 00 min 00 s at the same time as external input is applied. (The hours is rounded up for 30 minutes or higher and rounded down for 29 minutes or lower.)
When using two or more Time Switches, their times can be synchronized.

Input selection (F2)

- Set Input selection (F2) in initial setting mode to Time Adjustment Input.

Shaded portion indicates blinking of the indicator.

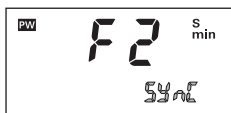

- Press **[h]** or **[m]** to change the display to **SYN**.
- Press **[WRITE]** to enter the setting.

Manual Operation on Recovery from Power Failure (F2)

Weekly, 2 Circuits Yearly, 2 Circuits

After power is restored to the H5S, it is possible to set the Time Switch to stop turning ON output until external input is applied.

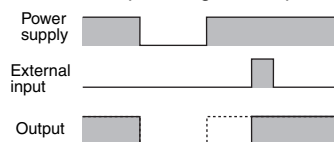

indicator (in the upper left corner of the screen)

Input selection (F2)

- Set Input selection (F2) in initial setting mode to Manual Operation on Recovery from Power Failure.

Shaded portion indicates blinking of the indicator.



- Press **[h]** or **[m]** to change the display to **b00:00**.
- Press **[WRITE]** to enter the setting.

Bank Switching (F2)

Weekly, 2 Circuits

Two groups (banks) of programs can be registered with the Time Switch. Banks can be switched by external input.

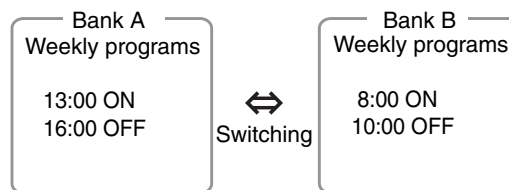

Input selection (F2)

- Set Input selection (F2) in initial setting mode to Bank Switching.

Shaded portion indicates blinking of the indicator.

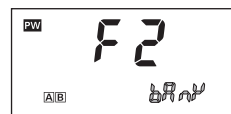

- Press **[h]** or **[m]** to change the display to **b00:00**.
- Press **[WRITE]** to enter the setting.

Switching banks in RUN mode

Banks are switched as shown in the following table depending on the external input state.

	Open-circuited	Short-circuited
Bank	A	B

Programming a bank

Press **[TIME ADJ]** in program setting mode to switch banks.

Different programs can be set for each bank.

Season Switching/Period of Season (F8/F9)

Yearly, 2 Circuits Yearly, 4 Circuits

Weekly programs can be set to automatically switch throughout the year in response to seasons.

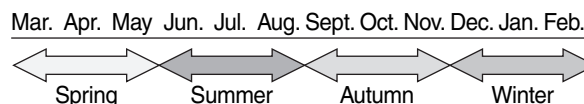

Seasons(*)	Spring	Summer	Autumn	Winter
Setting	17:30 ON 21:00 OFF	19:00 ON 22:00 OFF	18:00 ON 21:00 OFF	17:00 ON 21:00 OFF

* Up to four seasons can be set for 4-circuit models, and up to two seasons for 2-circuit models.

Season switching (F8)

- Turn ON Season switching (F8) in initial setting mode.

Shaded portion indicates blinking of the indicator.



- Press **[h]** or **[m]** to change the display to **00**.
- Press **[WRITE]** to enter the setting.

Note: The "C" and "D" indications are not displayed in 2-circuit models.

Period of Season (F9)

Shaded portion indicates blinking of the indicator.

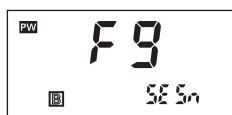

1. Press **[h]** or **[m]** to select the desired season.

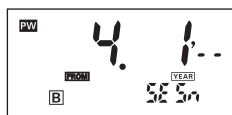

2. Press **[WRITE]** to enter the setting. The display then changes to the start period of season input screen. Press **[M]** or **[D]** to designate the starting date.



3. Press **[WRITE]** to enter the setting. The display then changes to the end period of season input screen. Press **[M]** or **[D]** to designate the ending date.

4. Press **[WRITE]** to enter the setting.

Note:

- The following is set as the default period of season.
A: 1.1 to 12.31 (1/1 to 12/31)
B to D: --.-- to --.-- (no setting)
*The "C" and "D" indications are not displayed in 2-circuit models.
- If overlapping periods are set, the priority becomes A<B<C<D.
For example, setting A (1/1 to 12/31) and B (4/1 to 9/30) will result in the following: 1/1 to 3/31: A, 4/1 to 9/30: B, 10/1 to 12/31: A.
- All outputs are OFF in the weekly program for all dates that do not come in any period.

Switching seasons

One group of programs is automatically switched to another, according to the seasons set in initial setting mode.*

* The season switching functions apply only to weekly programs, not yearly programs.

Programming a season

Press **[TIME ADJ]** in program setting mode to switch seasons. Different weekly programs can be set for each season.

Next Operation Display (F1)

Weekly, 2 Circuits Yearly, 2 Circuits Yearly, 4 Circuits

The order of the output channels for which the next operation (the next ON or OFF time) is set can be selected for the sub-display.

This function is useful when an operation in a particular circuit is to be monitored.

Parameters

- only 1** -----Displays the next operation for circuit 1 only.
- only 2** -----Displays the next operation for circuit 2 only.
- only 3** -----Displays the next operation for circuit 3 only.
- only 4** -----Displays the next operation for circuit 4 only.
- ALL 1234** -----Displays the next operation for all circuits.

Note: 1. Circuits 3 and 4 are not displayed for 2-circuit models.
2. **The inverted characters** indicate the default.

Setting method

Shaded portion indicates blinking of the indicator.

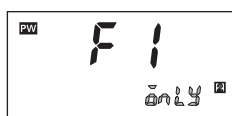

- Select one of the parameters using **[h]** or **[m]**.
- Press **[WRITE]** to enter the setting.

Date Format Selection (F5)

Yearly, 2 Circuits Yearly, 4 Circuits

The displayed date format is selectable between "month. day" and "day. month".

Parameters

mm.dd: "month. day"

dd.mm: "day. month"

Note: **The inverted characters** indicate the default.

Setting method

Shaded portion indicates blinking of the indicator.

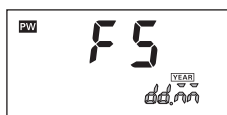

- Press **[h]** or **[m]** to select one of the parameters.
- Press **[WRITE]** to enter the setting.

Summer Time (DST) Adjustment (F6)

Yearly, 2 Circuits Yearly, 4 Circuits

Manual or automatic summer time adjustment can be selected.

Parameters

off: Manual adjustment

Auto: Automatic adjustment (Select summer time schedule in F7.)

Note: **The inverted characters** indicate the default.

Setting method

Shaded portion indicates blinking of the indicator.

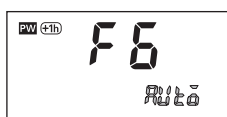

- Press **[h]** or **[m]** to select one of the parameters.
- Press **[WRITE]** to enter the setting.

Summer Time Schedule Selection (F7)

Yearly, 2 Circuits Yearly, 4 Circuits

The time and date when the Time Switch automatically switches to and from summer time can be selected with reference to the following regions.

Parameters

Regions	Summer time start date and time	Summer time end date and time
US (North America)	At 2:00 on the second Sunday in March	At 2:00 on the first Sunday in November
EU (Europe)	At 2:00 on the last Sunday in March	At 3:00 on the last Sunday in October
AUS (Australia)	At 2:00 on the last Sunday in October	At 3:00 on the last Sunday in March

Note: **The inverted characters** indicate the default.

Setting method

Shaded portion indicates blinking of the indicator.

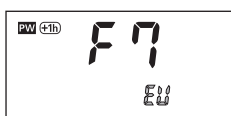

1. Press **[h]** or **[m]** to select one of the parameters.
2. Press **[WRITE]** to enter the setting.

About the Self Diagnosis Function

The following indications will be displayed when an error is generated.

Indication	Description	Output	Remedy
E1	CPU error	OFF	Press "RESET"
E2	Memory error	OFF	Press "RESET"

ALL DIMENSIONS SHOWN ARE IN MILLIMETERS.

To convert millimeters into inches, multiply by 0.03937. To convert grams into ounces, multiply by 0.03527.

In the interest of product improvement, specifications are subject to change without notice.

Read and Understand This Catalog

Please read and understand this catalog before purchasing the products. Please consult your OMRON representative if you have any questions or comments.

Warranty and Limitations of Liability

WARRANTY

OMRON's exclusive warranty is that the products are free from defects in materials and workmanship for a period of one year (or other period if specified) from date of sale by OMRON.

OMRON MAKES NO WARRANTY OR REPRESENTATION, EXPRESS OR IMPLIED, REGARDING NON-INFRINGEMENT, MERCHANTABILITY, OR FITNESS FOR PARTICULAR PURPOSE OF THE PRODUCTS. ANY BUYER OR USER ACKNOWLEDGES THAT THE BUYER OR USER ALONE HAS DETERMINED THAT THE PRODUCTS WILL SUITABLY MEET THE REQUIREMENTS OF THEIR INTENDED USE. OMRON DISCLAIMS ALL OTHER WARRANTIES, EXPRESS OR IMPLIED.

LIMITATIONS OF LIABILITY

OMRON SHALL NOT BE RESPONSIBLE FOR SPECIAL, INDIRECT, OR CONSEQUENTIAL DAMAGES, LOSS OF PROFITS OR COMMERCIAL LOSS IN ANY WAY CONNECTED WITH THE PRODUCTS, WHETHER SUCH CLAIM IS BASED ON CONTRACT, WARRANTY, NEGLIGENCE, OR STRICT LIABILITY.

In no event shall the responsibility of OMRON for any act exceed the individual price of the product on which liability is asserted.

IN NO EVENT SHALL OMRON BE RESPONSIBLE FOR WARRANTY, REPAIR, OR OTHER CLAIMS REGARDING THE PRODUCTS UNLESS OMRON'S ANALYSIS CONFIRMS THAT THE PRODUCTS WERE PROPERLY HANDLED, STORED, INSTALLED, AND MAINTAINED AND NOT SUBJECT TO CONTAMINATION, ABUSE, MISUSE, OR INAPPROPRIATE MODIFICATION OR REPAIR.

Application Considerations

SUITABILITY FOR USE

OMRON shall not be responsible for conformity with any standards, codes, or regulations that apply to the combination of products in the customer's application or use of the products.

At the customer's request, OMRON will provide applicable third party certification documents identifying ratings and limitations of use that apply to the products. This information by itself is not sufficient for a complete determination of the suitability of the products in combination with the end product, machine, system, or other application or use.

The following are some examples of applications for which particular attention must be given. This is not intended to be an exhaustive list of all possible uses of the products, nor is it intended to imply that the uses listed may be suitable for the products:

- Outdoor use, uses involving potential chemical contamination or electrical interference, or conditions or uses not described in this catalog.
- Nuclear energy control systems, combustion systems, railroad systems, aviation systems, medical equipment, amusement machines, vehicles, safety equipment, and installations subject to separate industry or government regulations.
- Systems, machines, and equipment that could present a risk to life or property.

Please know and observe all prohibitions of use applicable to the products.

NEVER USE THE PRODUCTS FOR AN APPLICATION INVOLVING SERIOUS RISK TO LIFE OR PROPERTY WITHOUT ENSURING THAT THE SYSTEM AS A WHOLE HAS BEEN DESIGNED TO ADDRESS THE RISKS, AND THAT THE OMRON PRODUCTS ARE PROPERLY RATED AND INSTALLED FOR THE INTENDED USE WITHIN THE OVERALL EQUIPMENT OR SYSTEM.

PROGRAMMABLE PRODUCTS

OMRON shall not be responsible for the user's programming of a programmable product, or any consequence thereof.

Disclaimers

CHANGE IN SPECIFICATIONS

Product specifications and accessories may be changed at any time based on improvements and other reasons.

It is our practice to change model numbers when published ratings or features are changed, or when significant construction changes are made. However, some specifications of the products may be changed without any notice. When in doubt, special model numbers may be assigned to fix or establish key specifications for your application on your request. Please consult with your OMRON representative at any time to confirm actual specifications of purchased products.

DIMENSIONS AND WEIGHTS

Dimensions and weights are nominal and are not to be used for manufacturing purposes, even when tolerances are shown.

PERFORMANCE DATA

Performance data given in this catalog is provided as a guide for the user in determining suitability and does not constitute a warranty. It may represent the result of OMRON's test conditions, and the users must correlate it to actual application requirements. Actual performance is subject to the OMRON Warranty and Limitations of Liability.

ERRORS AND OMISSIONS

The information in this document has been carefully checked and is believed to be accurate; however, no responsibility is assumed for clerical, typographical, or proofreading errors, or omissions.

2012.8

In the interest of product improvement, specifications are subject to change without notice.

OMRON Corporation
Industrial Automation Company

<http://www.ia.omron.com/>

(c)Copyright OMRON Corporation 2012 All Right Reserved.

Mouser Electronics

Authorized Distributor

Click to View Pricing, Inventory, Delivery & Lifecycle Information:

Omron:

[H5S-WB2D](#) [H5S-YFB2-X](#) [H5S-FB](#) [H5S-B](#) [H5S-YB2-X](#) [H5S-YB2D-X](#)