

Automotive high efficiency ultrafast diode

Features

- Suited for SMPS
- Low losses
- Low forward and reverse recovery times
- High junction temperature
- Low leakage current
- AEC-Q101 qualified

Description

Dual center tap rectifier suited for switch mode power supplies and high frequency DC to DC converters.

Packaged in DPAK and D²PAK, this device is intended for use in low voltage, high frequency inverters, free wheeling and polarity protection for automotive applications.

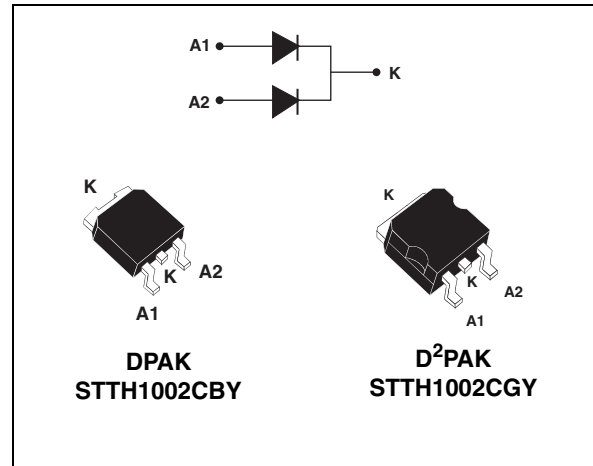

Table 1. Device summary

Symbol	Value
$I_{F(AV)}$	Up to 2 x 8 A
V_{RRM}	200 V
T_j (max)	175 °C
V_F (typ)	0.78 V
t_{rr} (typ)	20 ns

1 Characteristics

Table 2. Absolute ratings (limiting values, per diode)

Symbol	Parameter		Value	Unit	
V_{RRM}	Repetitive peak reverse voltage		200	V	
$I_{F(RMS)}$	Forward rms current	D ² PAK	20	A	
		DPAK	10		
$I_{F(AV)}$	Average forward current $\delta = 0.5$	$T_c = 155\text{ }^\circ\text{C}$	Per diode	5	A
		$T_c = 150\text{ }^\circ\text{C}$	Per device	10	
		$T_c = 135\text{ }^\circ\text{C}$	Per diode	8	
		$T_c = 125\text{ }^\circ\text{C}$	Per device	16	
I_{FSM}	Surge non repetitive forward current	$t_p = 10\text{ ms}$ sinusoidal	50	A	
T_{stg}	Storage temperature range		-65 to + 175	$^\circ\text{C}$	
T_j	Operating junction temperature range		-40 to + 175	$^\circ\text{C}$	

Table 3. Thermal parameters

Symbol	Parameter		Value (max)	Unit
$R_{th(j-c)}$	Junction to case	Per diode	4.0	$^\circ\text{C/W}$
		Per device	2.5	
$R_{th(j-c)}$	Coupling		1.0	

When the diodes 1 and 2 are used simultaneously:

$$\Delta T_j (\text{diode1}) = P(\text{diode1}) \times R_{th(j-c)} (\text{per diode}) + P(\text{diode2}) \times R_{th(c)}$$

Table 4. Static electrical characteristics (per diode)

Symbol	Parameter	Test conditions		Min.	Typ.	Max.	Unit
$I_R^{(1)}$	Reverse leakage current	$T_j = 25\text{ }^\circ\text{C}$	$V_R = V_{RRM}$			5	μA
		$T_j = 125\text{ }^\circ\text{C}$			3	40	
$V_F^{(2)}$	Forward voltage drop	$T_j = 25\text{ }^\circ\text{C}$	$I_F = 5\text{ A}$			1.1	V
		$T_j = 25\text{ }^\circ\text{C}$	$I_F = 10\text{ A}$			1.25	
		$T_j = 150\text{ }^\circ\text{C}$	$I_F = 5\text{ A}$		0.78	0.89	
		$T_j = 150\text{ }^\circ\text{C}$	$I_F = 10\text{ A}$			1.05	

1. Pulse test: $t_p = 5\text{ ms}$, $\delta < 2\%$

2. Pulse test: $t_p = 380\text{ }\mu\text{s}$, $\delta < 2\%$

To evaluate the conduction losses use the following equation:

$$P = 0.73 \times I_{F(AV)} + 0.032 I_{F(RMS)}^2$$

Table 5. Dynamic electrical characteristics

Symbol	Parameter	Test conditions		Min.	Typ.	Max.	Unit
t_{rr}	Reverse recovery time	$T_j = 25\text{ °C}$	$I_F = 1\text{ A}$ $V_R = 30\text{ V}$ $di_F/dt = 100\text{ A}/\mu\text{s}$		20	25	ns
I_{RM}	Reverse recovery current	$T_j = 125\text{ °C}$	$I_F = 5\text{ A}$ $V_R = 160\text{ V}$ $di_F/dt = 200\text{ A}/\mu\text{s}$		5.9	7.6	A
t_{fr}	Forward recovery time	$T_j = 25\text{ °C}$	$I_F = 5\text{ A}$ $di_F/dt = 100\text{ A}/\mu\text{s}$ $V_{FR} = 1.1 \times V_{Fmax}$			110	ns
V_{FP}	Forward recovery voltage	$T_j = 25\text{ °C}$	$I_F = 5\text{ A}$ $di_F/dt = 100\text{ A}/\mu\text{s}$		2.4		V

Figure 1. Peak current versus duty cycle (per diode)

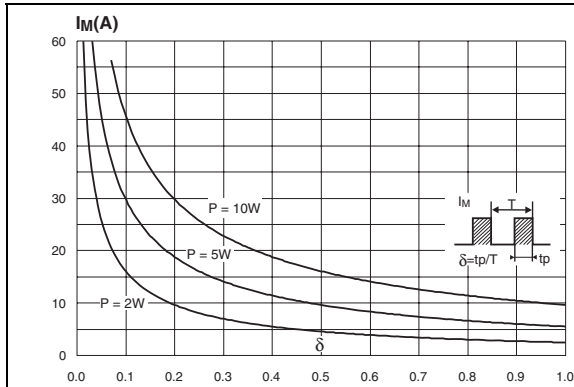

Figure 2. Forward voltage drop versus forward current (typical values, per diode)

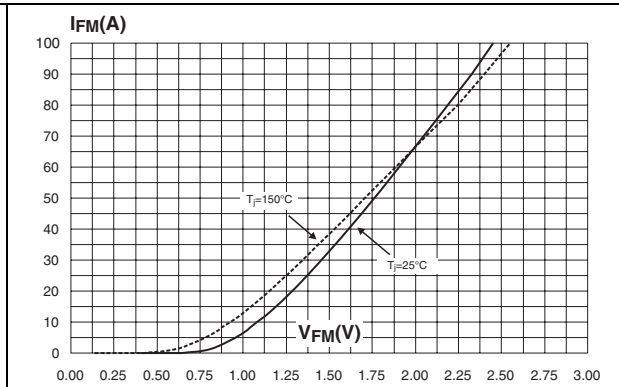

Figure 3. Forward voltage drop versus forward current (maximum values, per diode)

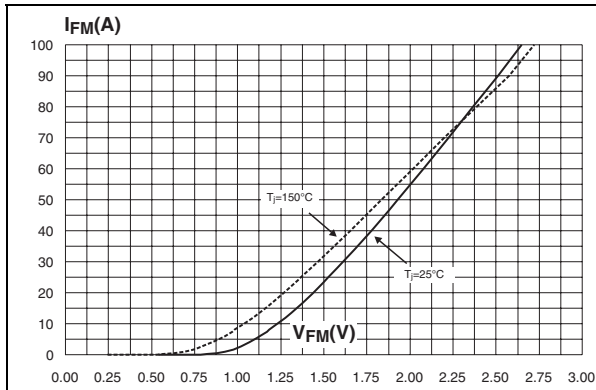

Figure 4. Relative variation of thermal impedance junction to case versus pulse duration

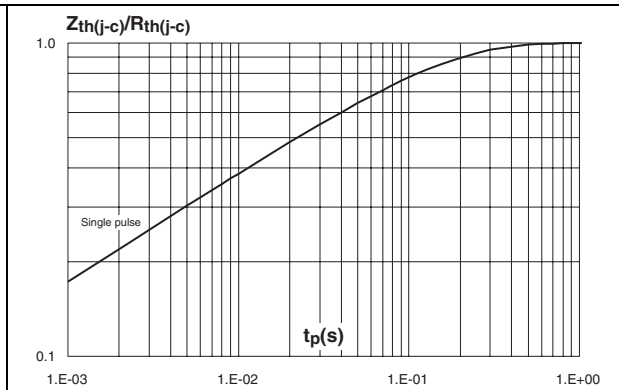

Figure 5. Junction capacitance versus reverse voltage applied (typical values, per diode)

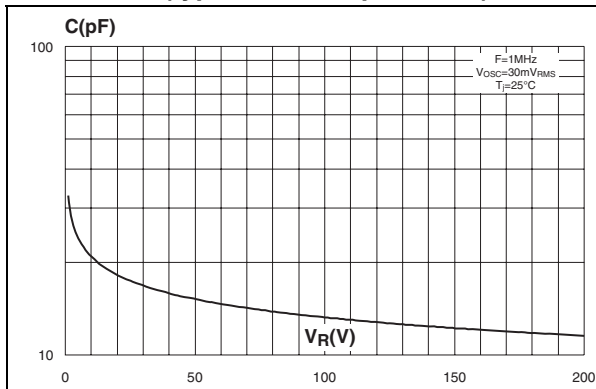

Figure 6. Reverse recovery charges versus dI_F/dt (typical values, per diode)

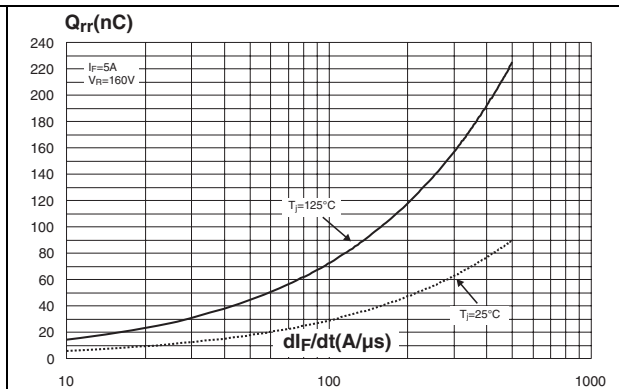

Figure 7. Reverse recovery time versus di_F/dt (typical values, per diode)

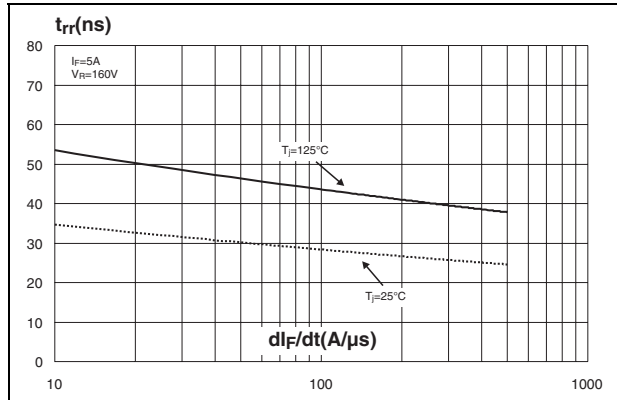

Figure 8. Peak reverse recovery current versus di_F/dt (typical values, per diode)

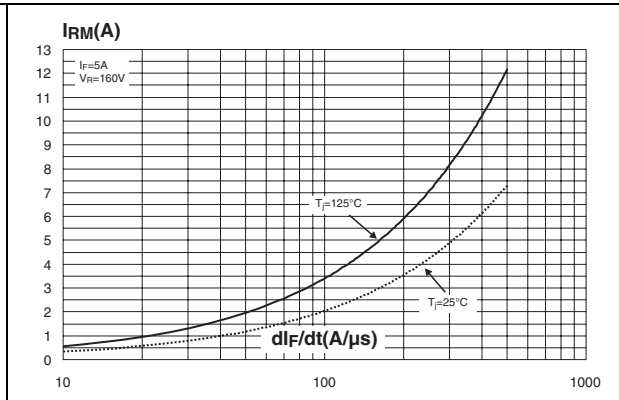

Figure 9. Dynamic parameters versus junction temperature

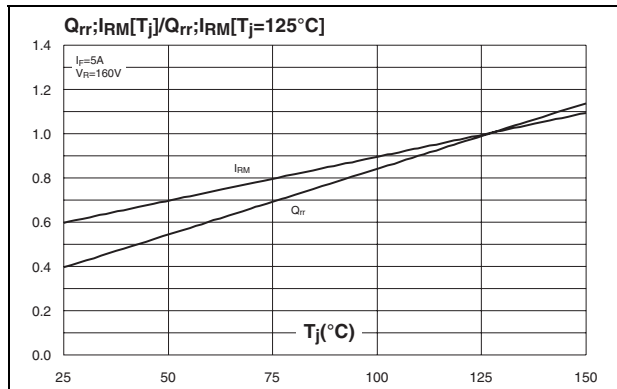

Figure 10. Thermal resistance junction to ambient versus copper surface under tab for D²PAK

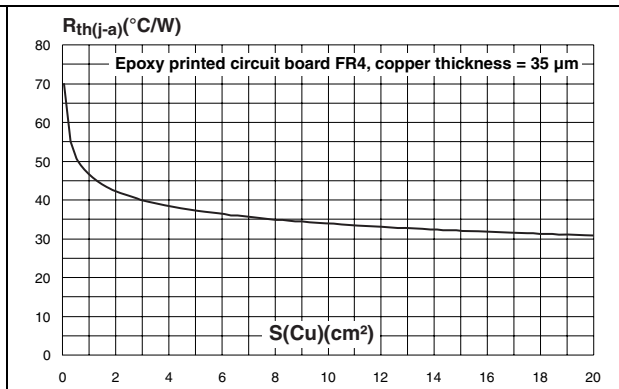
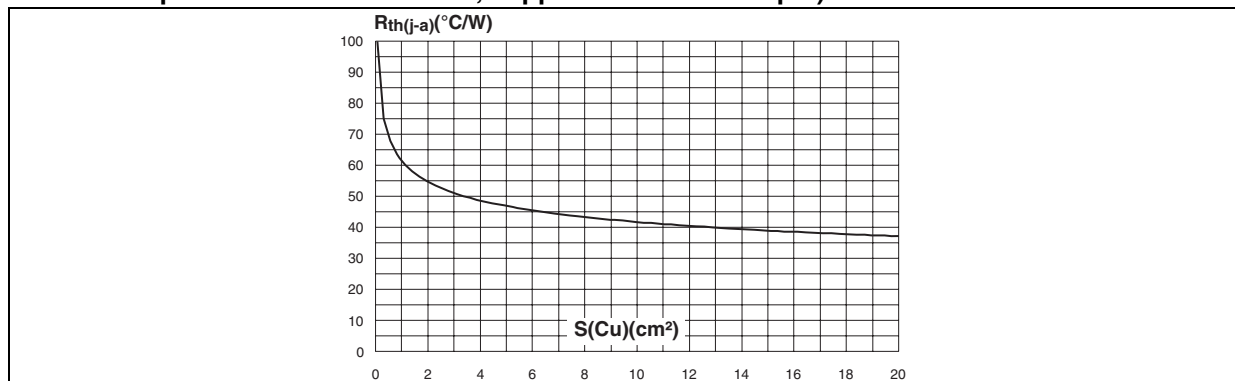

Figure 11. Thermal resistance junction to ambient versus copper surface under tab (Epoxy printed circuit board FR4, copper thickness = 35 μm) for DPAK



2 Package mechanical data

- Epoxy meets UL94, V0
- Cooling method: by conduction (method C)

In order to meet environmental requirements, ST offers these devices in different grades of ECOPACK® packages, depending on their level of environmental compliance. ECOPACK® specifications, grade definitions and product status are available at: www.st.com. ECOPACK® is an ST trademark.

Table 6. DPAK dimensions

Ref.	Dimensions			
	Millimeters		Inches	
	Min.	Max.	Min.	Max.
A	2.20	2.40	0.086	0.094
A1	0.90	1.10	0.035	0.043
A2	0.03	0.23	0.001	0.009
B	0.64	0.90	0.025	0.035
B2	5.20	5.40	0.204	0.212
C	0.45	0.60	0.017	0.023
C2	0.48	0.60	0.018	0.023
D	6.00	6.20	0.236	0.244
E	6.40	6.60	0.251	0.259
G	4.40	4.60	0.173	0.181
H	9.35	10.10	0.368	0.397
L2	0.80 typ.		0.031 typ.	
L4	0.60	1.00	0.023	0.039
V2	0°	8°	0°	8°

Figure 12. Footprint (dimensions in mm)

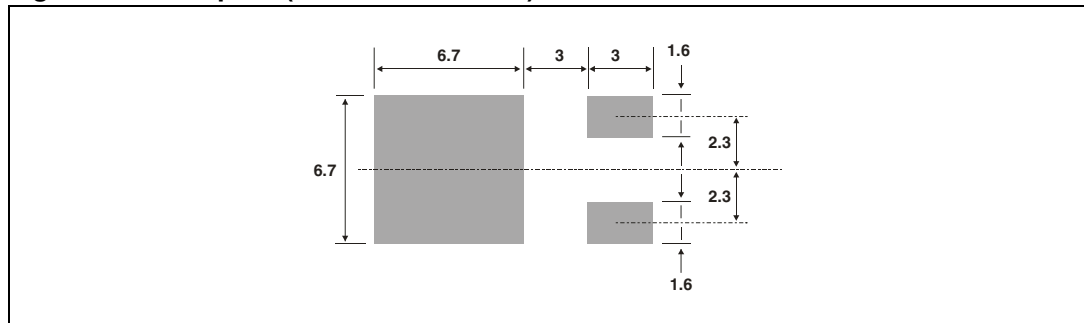
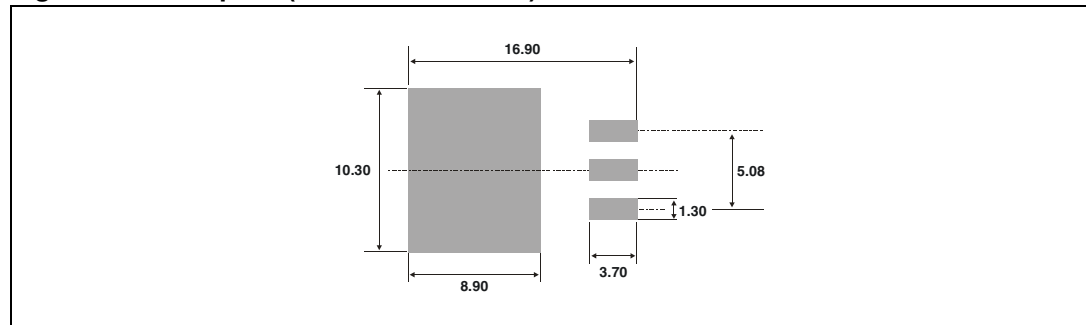

Table 7. D²PAK dimensions

Ref.	Dimensions			
	Millimeters		Inches	
	Min.	Max.	Min.	Max.
A	4.40	4.60	0.173	0.181
A1	2.49	2.69	0.098	0.106
A2	0.03	0.23	0.001	0.009
B	0.70	0.93	0.027	0.037
B2	1.14	1.70	0.045	0.067
C	0.45	0.60	0.017	0.024
C2	1.23	1.36	0.048	0.054
D	8.95	9.35	0.352	0.368
E	10.00	10.40	0.393	0.409
G	4.88	5.28	0.192	0.208
L	15.00	15.85	0.590	0.624
L2	1.27	1.40	0.050	0.055
L3	1.40	1.75	0.055	0.069
M	2.40	3.20	0.094	0.126
R	0.40 typ.		0.016 typ.	
V2	0°	8°	0°	8°

Figure 13. Footprint (dimensions in mm)



3 Ordering information

Table 8. Ordering information

Order code	Marking	Package	Weight	Base qty	Delivery mode
STTH1002CBY-TR	STTH1002CY	DPAK	0.3 g	2500	Tape and reel
STTH1002CGY-TR	STTH1002CGY	D ² PAK	1.48 g	1000	

4 Revision history

Table 9. Document revision history

Date	Revision	Changes
21-Oct-2010	1	First issue.
03-Nov-2011	2	Updated Table 7 and Table 8 .

Please Read Carefully:

Information in this document is provided solely in connection with ST products. STMicroelectronics NV and its subsidiaries ("ST") reserve the right to make changes, corrections, modifications or improvements, to this document, and the products and services described herein at any time, without notice.

All ST products are sold pursuant to ST's terms and conditions of sale.

Purchasers are solely responsible for the choice, selection and use of the ST products and services described herein, and ST assumes no liability whatsoever relating to the choice, selection or use of the ST products and services described herein.

No license, express or implied, by estoppel or otherwise, to any intellectual property rights is granted under this document. If any part of this document refers to any third party products or services it shall not be deemed a license grant by ST for the use of such third party products or services, or any intellectual property contained therein or considered as a warranty covering the use in any manner whatsoever of such third party products or services or any intellectual property contained therein.

UNLESS OTHERWISE SET FORTH IN ST'S TERMS AND CONDITIONS OF SALE ST DISCLAIMS ANY EXPRESS OR IMPLIED WARRANTY WITH RESPECT TO THE USE AND/OR SALE OF ST PRODUCTS INCLUDING WITHOUT LIMITATION IMPLIED WARRANTIES OF MERCHANTABILITY, FITNESS FOR A PARTICULAR PURPOSE (AND THEIR EQUIVALENTS UNDER THE LAWS OF ANY JURISDICTION), OR INFRINGEMENT OF ANY PATENT, COPYRIGHT OR OTHER INTELLECTUAL PROPERTY RIGHT.

UNLESS EXPRESSLY APPROVED IN WRITING BY TWO AUTHORIZED ST REPRESENTATIVES, ST PRODUCTS ARE NOT RECOMMENDED, AUTHORIZED OR WARRANTED FOR USE IN MILITARY, AIR CRAFT, SPACE, LIFE SAVING, OR LIFE SUSTAINING APPLICATIONS, NOR IN PRODUCTS OR SYSTEMS WHERE FAILURE OR MALFUNCTION MAY RESULT IN PERSONAL INJURY, DEATH, OR SEVERE PROPERTY OR ENVIRONMENTAL DAMAGE. ST PRODUCTS WHICH ARE NOT SPECIFIED AS "AUTOMOTIVE GRADE" MAY ONLY BE USED IN AUTOMOTIVE APPLICATIONS AT USER'S OWN RISK.

Resale of ST products with provisions different from the statements and/or technical features set forth in this document shall immediately void any warranty granted by ST for the ST product or service described herein and shall not create or extend in any manner whatsoever, any liability of ST.

ST and the ST logo are trademarks or registered trademarks of ST in various countries.

Information in this document supersedes and replaces all information previously supplied.

The ST logo is a registered trademark of STMicroelectronics. All other names are the property of their respective owners.

© 2011 STMicroelectronics - All rights reserved

STMicroelectronics group of companies

Australia - Belgium - Brazil - Canada - China - Czech Republic - Finland - France - Germany - Hong Kong - India - Israel - Italy - Japan - Malaysia - Malta - Morocco - Philippines - Singapore - Spain - Sweden - Switzerland - United Kingdom - United States of America

www.st.com

Mouser Electronics

Authorized Distributor

Click to View Pricing, Inventory, Delivery & Lifecycle Information:

[STMicroelectronics:](#)

[STTH1002CGY-TR](#) [STTH1002CBY-TR](#)