

LOC		DIST		P		F		ZONE		LTR		REVISIONS		DATE	APPD	
CM	53												D	REV PER EC 061B-0103-98	6-11-98	JH RS

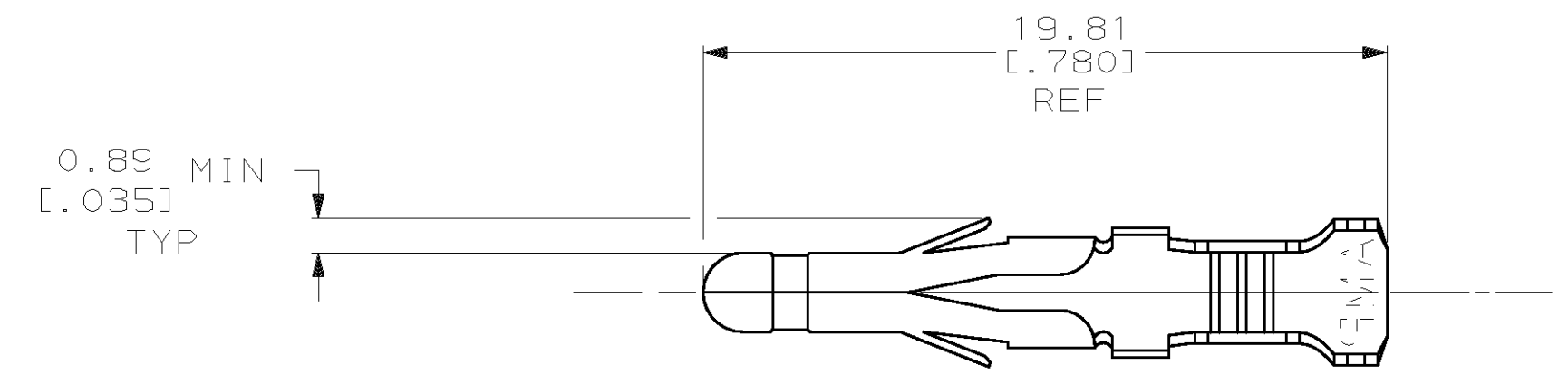

- 1 0.00076 [.000030] MIN GOLD IN LOCALIZED GOLD PLATE AREA OVER 0.00127 [.000050] MIN NICKEL.
- 2 WIRE RANGE: 0.3 - 0.84mm² (24-18 AWG).
- 3 INSULATION RANGE: 2.79 [.110] MAX. DIA.
- 4 DIMENSIONS IN BRACKETS ARE IN INCHES.

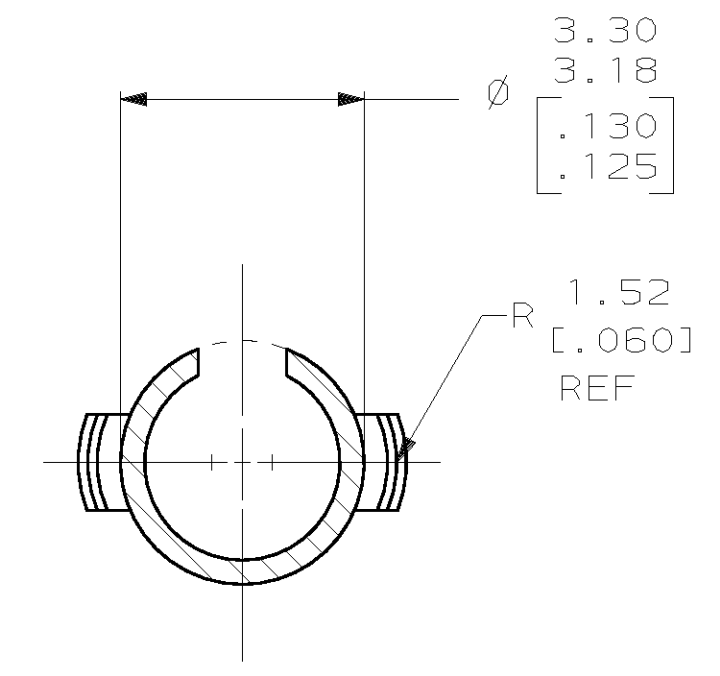
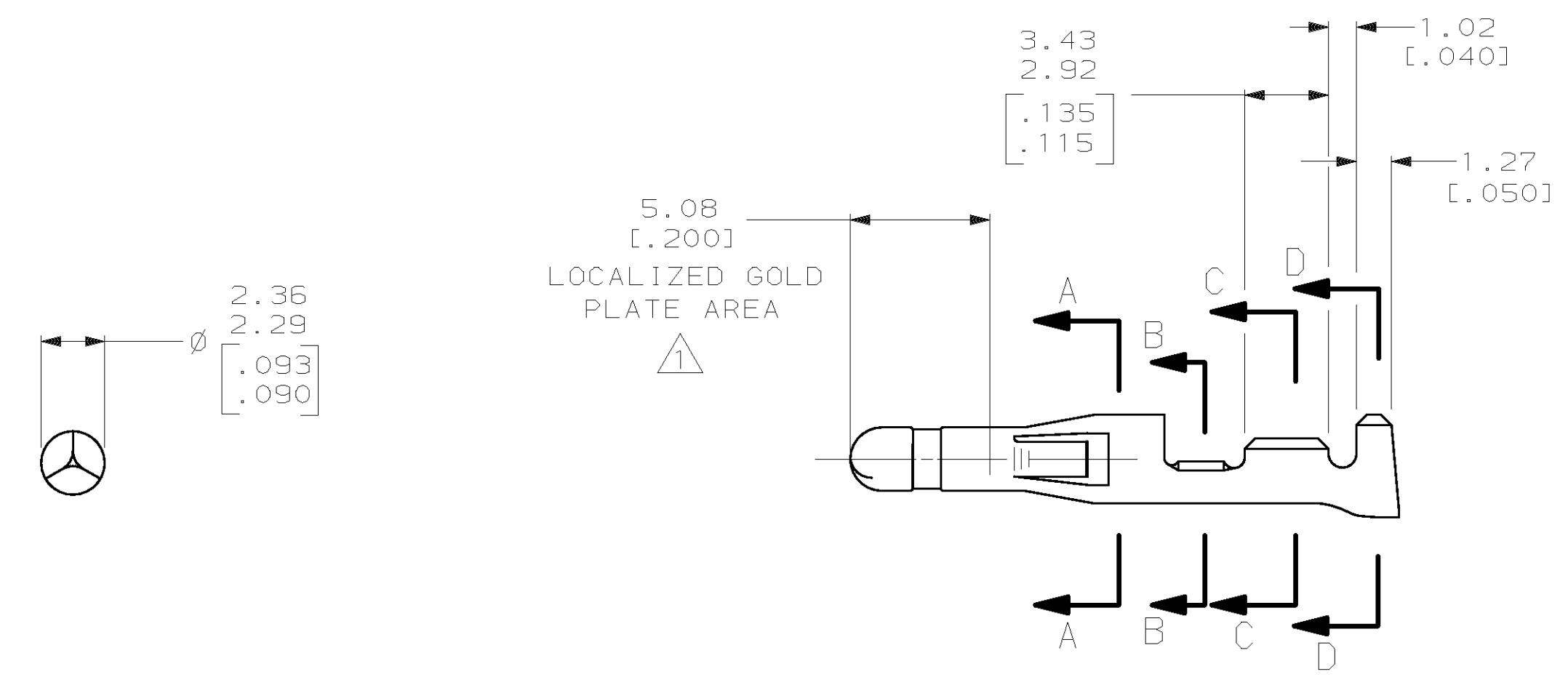

SECTION A-A
SCALE 10:1

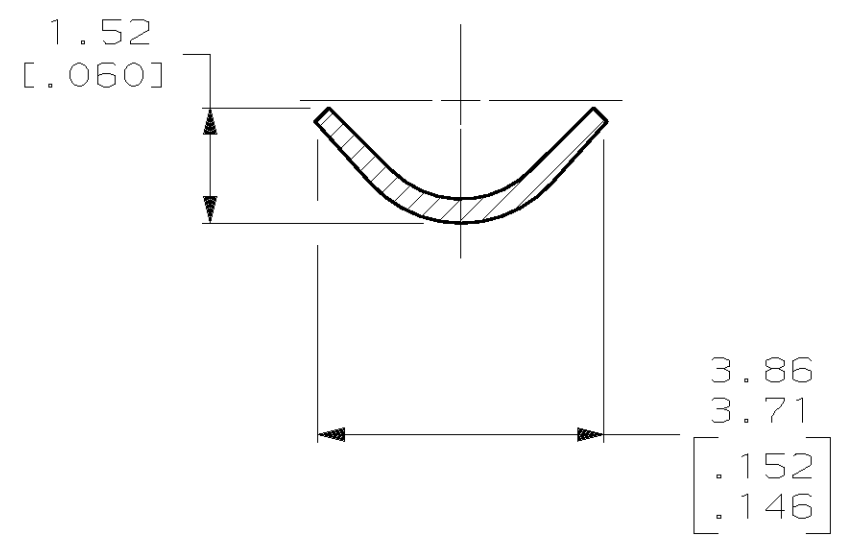

SECTION B-B
SCALE 10:1

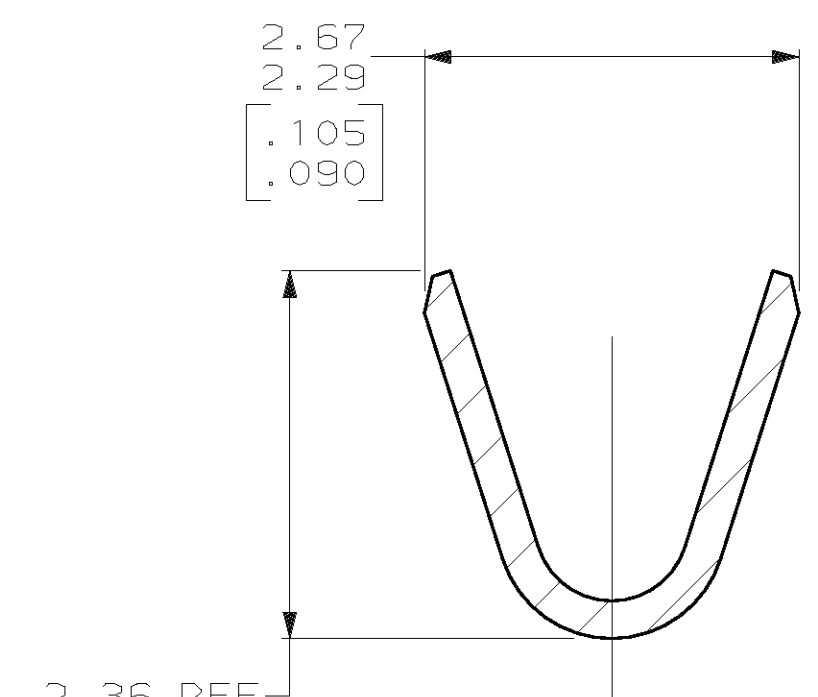

SECTION C-C
SCALE 10:1

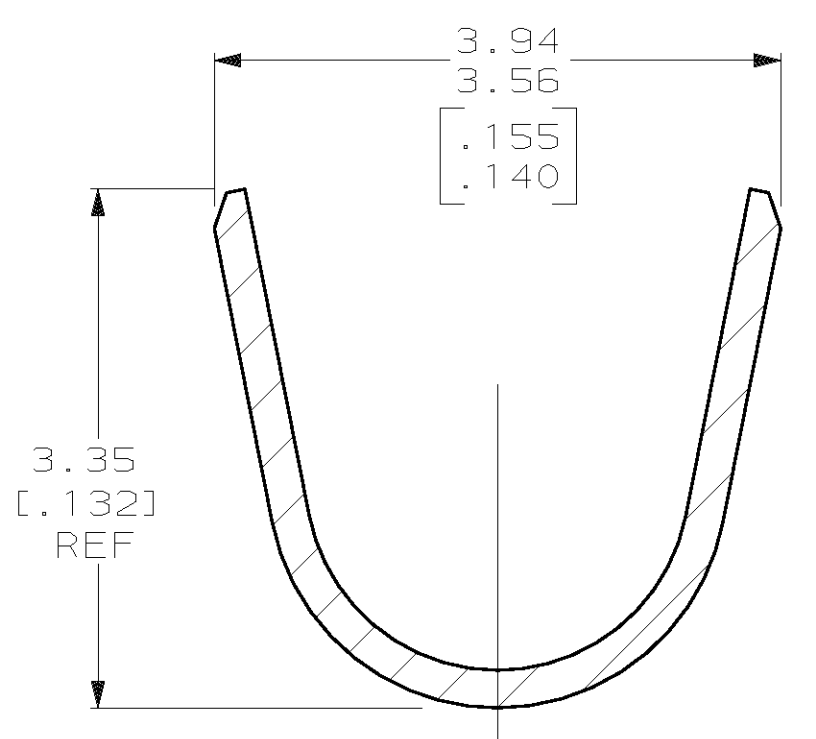

SECTION D-D
SCALE 10:1

METRIC

THIS DRAWING IS A CONTROLLED DOCUMENT FOR AMP INCORPORATED. IT IS SUBJECT TO CHANGE AND THE CONTROLLING ENGINEERING ORGANIZATION SHOULD BE CONTACTED FOR THE LATEST REVISION.

FINISH	MATERIAL	PART NO
△	0.25 [.010] BRASS	770147-5
PRE-TIN	0.25 [.010] BRASS	770147-1

DO NOT SCALE PRINT. UNLESS SPECIFIED DIMENSIONS IN mm [INCHES]	DR 11-3-93 R. VESTAL
TOLERANCES ON:	CHK 11-3-93 R. SWING
2 PLC DEC ± 0.13 [.005]	APPD 11-3-93 C. CASH
3 PLC DEC ± -	APPD 11-3-93 C. CASH
ANGLES ± -	PRODUCT SPEC
MATERIAL	SEE TABLE
FINISH	SEE TABLE
APPLICATION SPEC	-
WEIGHT	-

AMP AMP Incorporated Harrisburg, PA 17105-3608		
NAME PIN, .093, LOOSE PIECE, COMMERCIAL PIN AND SOCKET		
SIZE	CAGE CODE	DRAWING NO
D	00779	C-770147
SCALE	5:1	SHEET 1 OF 1

Mouser Electronics

Authorized Distributor

Click to View Pricing, Inventory, Delivery & Lifecycle Information:

[TE Connectivity:](#)

[770147-5](#)