

THIS DOCUMENT IS THE PROPERTY OF
KEYSTONE ELECTRONICS CORP. AND
SHALL NOT BE REPRODUCED, DISTRIBUTED
OR USED AS A BASIS FOR MANUFACTURE
WITHOUT PRIOR WRITTEN PERMISSION
FROM KEYSTONE ELECTRONICS CORP.

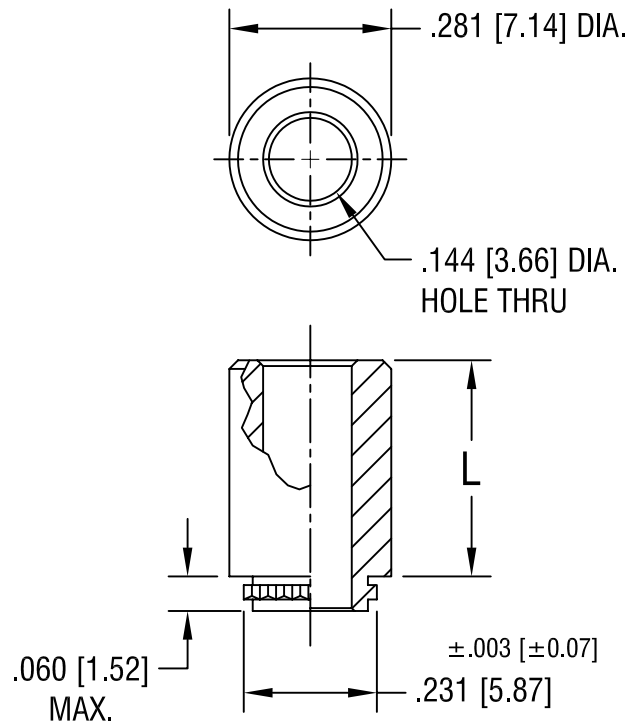

PART NO.	'L' DIM.
4855	.065 [1.65]
4856	.125 [3.18]
4857	.250 [6.35]
4858	.375 [9.53]
4859	.500 [12.70]

KEYSTONE ELECTRONICS CORP.

ASTORIA, N.Y. 11105-2017

PART NAME

FORCE-FIT STANDOFF, CLEAR HOLE

MATERIAL

STAINLESS STEEL

FINISH

-

DRN BY

BOONE

DATE

4.22.96

APP'D

LN

SCALE

3X

12.19.05 CHANGE AS PER ECN 05-084

A

TOLERANCES

INCH [MM]

DECIMAL ±.005 [±0.15]

ANGULAR ± 1°
UNLESS OTHERWISE SPECIFIED

CODE

C/M

DWG NO.

4855-4859

DATE

DESCRIPTION

REV.

Mouser Electronics

Authorized Distributor

Click to View Pricing, Inventory, Delivery & Lifecycle Information:

[Keystone Electronics:](#)

[4856](#)