

24-V Input Voltage, 150-mA, Ultralow I_Q Low-Dropout Regulators

FEATURES

- **Wide Input Voltage Range: 2.5 V to 24 V**
- **Low 3.2- μ A Quiescent Current**
- **Ground Pin Current: 3.4 μ A at 100-mA I_{OUT}**
- **Stable with Any Capacitor (> 0.47 μ F)**
- **Available in SOT23-5 Package**
- **Operating Junction Temperature:
–40°C to +125°C**

APPLICATIONS

- **Ultralow Power Microcontrollers**
- **E-Meters**
- **Fire Alarms/Smoke Detector Systems**
- **Handset Peripherals**
- **Industrial/Automotive Applications**
- **Remote Controllers**
- **Zigbee™ Networks**
- **PDA's**
- **Portable, Battery-Powered Equipment**

DESCRIPTION

The TLV701xx series of low-dropout (LDO) regulators are ultralow quiescent current devices designed for extremely power-sensitive applications. Quiescent current is virtually constant over the complete load current and ambient temperature range. These devices are an ideal power management attachment to low-power microcontrollers, such as the [MSP430](#).

The TLV701xx operates over a wide operating input voltage of 2.5 V to 24 V. Thus, it is an excellent choice for both battery-powered systems as well as industrial applications that see large line transients.

The TLV701xx is available in a 3-mm \times 3-mm SOT23-5 package that is ideal for cost-effective board manufacturing.

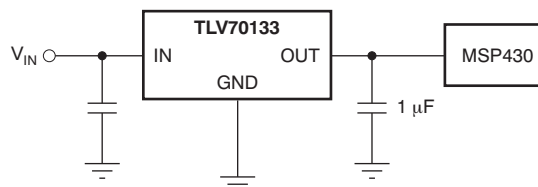
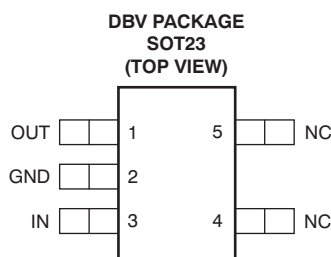

Please be aware that an important notice concerning availability, standard warranty, and use in critical applications of Texas Instruments semiconductor products and disclaimers thereto appears at the end of this data sheet.

ZigBee is a trademark of ZigBee Alliance.

All other trademarks are the property of their respective owners.



This integrated circuit can be damaged by ESD. Texas Instruments recommends that all integrated circuits be handled with appropriate precautions. Failure to observe proper handling and installation procedures can cause damage.

ESD damage can range from subtle performance degradation to complete device failure. Precision integrated circuits may be more susceptible to damage because very small parametric changes could cause the device not to meet its published specifications.

AVAILABLE OPTIONS⁽¹⁾

PRODUCT	V _{OUT}
TLV701xxyyyz	XX is nominal output voltage (for example, 30 = 3.0 V) YYY is Package Designator Z is Package Quantity

- (1) For the most current package and ordering information, see the Package Option Addendum at the end of this document, or visit the device product folder at www.ti.com.

ABSOLUTE MAXIMUM RATINGS⁽¹⁾

Over operating free-air temperature range, unless otherwise noted.

		VALUE		UNIT
		MIN	MAX	
Voltage ⁽²⁾	IN	-0.3	24	V
Current source	OUT	Internally limited		
Temperature	Operating junction, T _J	-40	+150	°C
	Storage, T _{stg}	-65	+150	°C
Electrostatic Discharge Rating ⁽³⁾	Human body model (HBM) QSS 009-105 (JESD22-A114A)		2	kV
	Charged device model (CDM) QSS 009-147 (JESD22-C101B.01)		500	V

- (1) Stresses beyond those listed under *absolute maximum ratings* may cause permanent damage to the device. These are stress ratings only, and functional operation of the device at these or any other conditions beyond those indicated under *recommended operating conditions* is not implied. Exposure to absolute-maximum-rated conditions for extended periods may affect device reliability.
- (2) All voltages are with respect to network ground terminal.
- (3) ESD testing is performed according to the respective JESD22 JEDEC standard.

THERMAL INFORMATION

THERMAL METRIC ⁽¹⁾		TLV701XX	UNITS
		DBV	
		5 PINS	
θ_{JA}	Junction-to-ambient thermal resistance	213.1	°C/W
θ_{JcTop}	Junction-to-case (top) thermal resistance	110.9	
θ_{JB}	Junction-to-board thermal resistance	97.4	
ψ_{JT}	Junction-to-top characterization parameter	22.0	
ψ_{JB}	Junction-to-board characterization parameter	78.4	
θ_{JcBot}	Junction-to-case (bottom) thermal resistance	n/a	

- (1) For more information about traditional and new thermal metrics, see the *IC Package Thermal Metrics* application report, [SPRA953](http://www.ti.com).

ELECTRICAL CHARACTERISTICS: $T_A = +25^\circ\text{C}$

All values are at $T_A = +25^\circ\text{C}$, $V_{IN} = V_{OUT(nom)} + 1\text{ V}$, $I_{OUT} = 1\text{ mA}$, and $C_{OUT} = 1\text{ }\mu\text{F}$, unless otherwise noted.

PARAMETER	TEST CONDITIONS	TLV701xx			UNIT	
		MIN	TYP	MAX		
V_O	Input voltage range			24	V	
	Output voltage range	1.2		5	V	
V_{OUT}	DC output accuracy	-2		2	%	
ΔV_O for ΔV_{IN}	Line regulation	$V_{OUT(NOM)} + 1\text{ V} < V_{IN} < 24\text{ V}$		20	50	mV
ΔV_O for ΔI_{OUT}	Load regulation	$1\text{ mA} < I_{OUT} < 10\text{ mA}$		6		mV
		$1\text{ mA} < I_{OUT} < 50\text{ mA}$		19		mV
		$1\text{ mA} < I_{OUT} < 100\text{ mA}$		29	50	mV
V_{DO}	Dropout voltage ⁽¹⁾	$I_{OUT} = 10\text{ mA}$		75		mV
		$I_{OUT} = 50\text{ mA}$		400		mV
I_{CL}	Output current limit	$V_{OUT} = 0\text{ V}$		160	1000	mA
I_{GND}	Ground pin current	$I_{OUT} = 0\text{ mA}$		3.2	4.5	μA
		$I_{OUT} = 100\text{ mA}$		3.4	5.5	μA
PSRR	Power-supply rejection ratio	$f = 100\text{ kHz}$, $C_{OUT} = 10\text{ }\mu\text{F}$		60		dB

(1) $V_{IN} = V_{OUT(NOM)} - 0.1\text{ V}$.

FUNCTIONAL BLOCK DIAGRAM

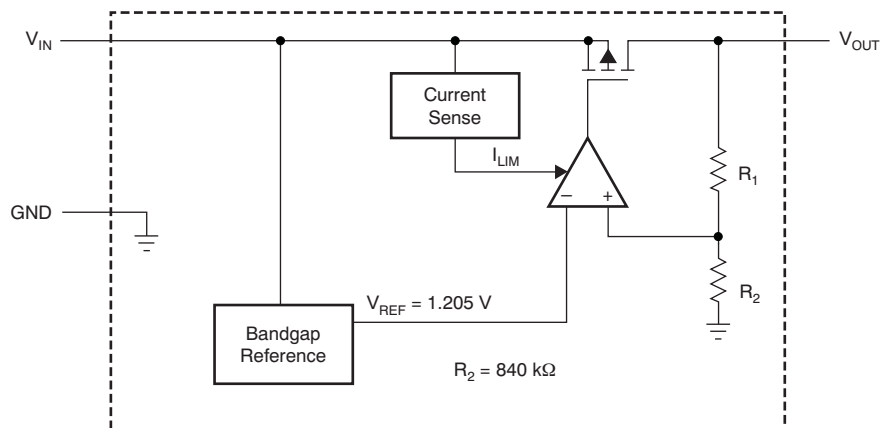

PRODUCT PREVIEW

PIN CONFIGURATIONS

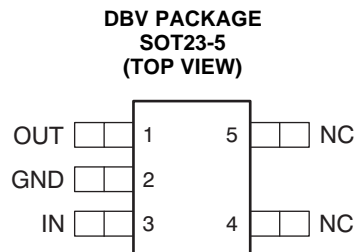

Table 1. Pin Descriptions

TLV701xx		
NAME	DBV	DESCRIPTION
GND	2	Ground
IN	3	Unregulated input voltage.
OUT	1	Regulated output voltage. Any capacitor 1 μ F or greater between this pin and ground is needed for stability.
NC	4, 5	No connection. This pin can be left open or tied to ground for improved thermal performance.

TYPICAL CHARACTERISTICS

LINE REGULATION

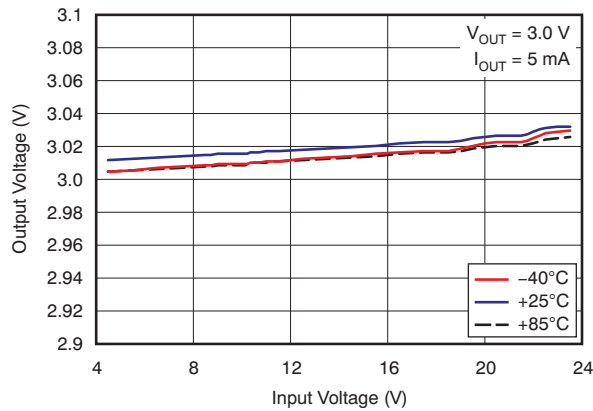

Figure 1.

LOAD REGULATION
($V_{OUT} = 3.0\text{ V}$)

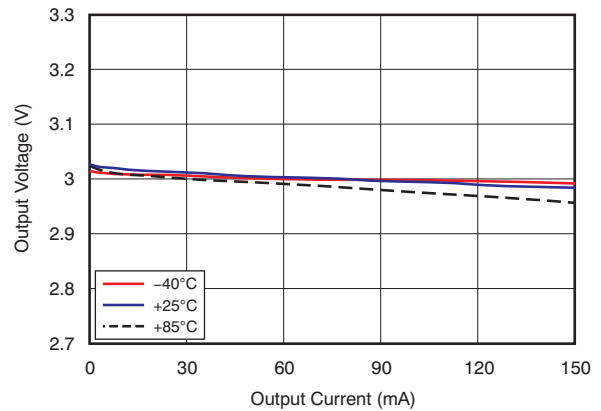

Figure 2.

OUTPUT VOLTAGE vs
JUNCTION TEMPERATURE

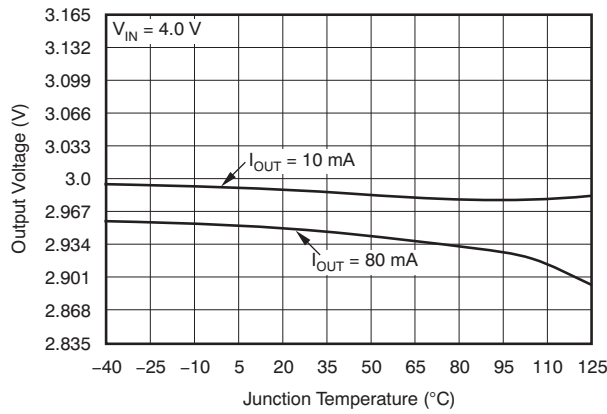

Figure 3.

DROPOUT VOLTAGE vs INPUT VOLTAGE

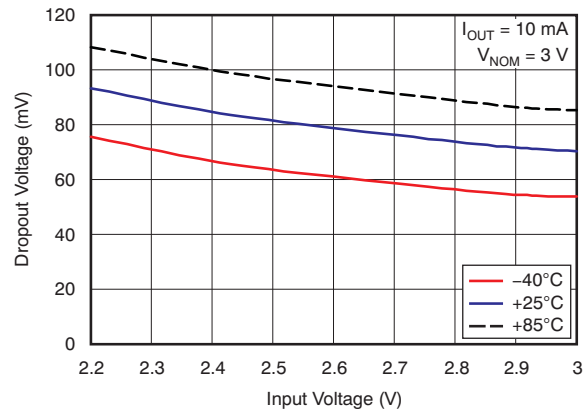

Figure 4.

DROPOUT VOLTAGE vs OUTPUT CURRENT

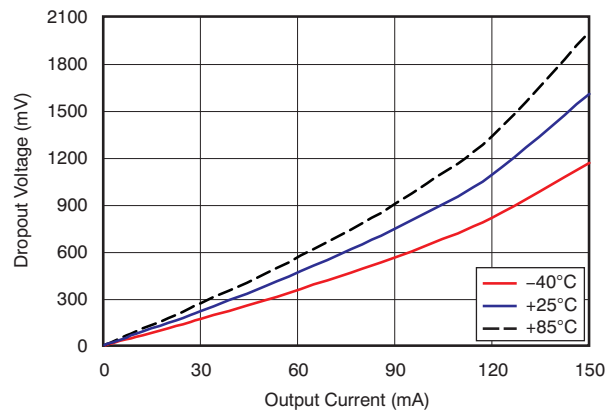

Figure 5.

GROUND CURRENT vs JUNCTION TEMPERATURE

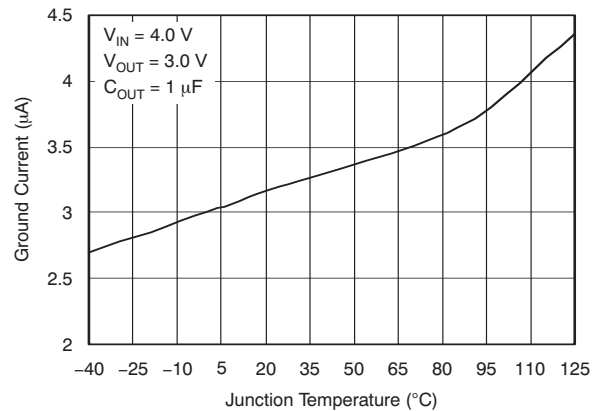

Figure 6.

PRODUCT PREVIEW

TYPICAL CHARACTERISTICS (continued)

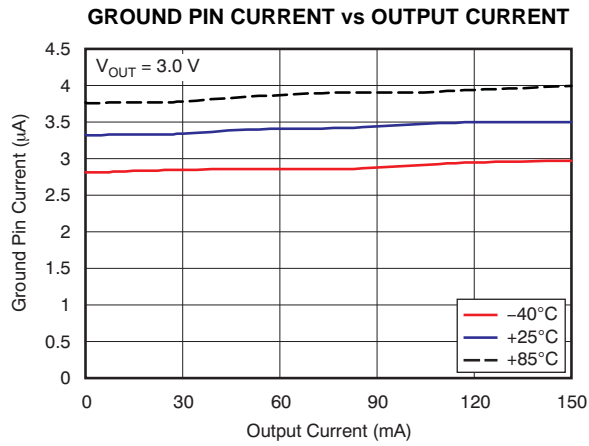

Figure 7.

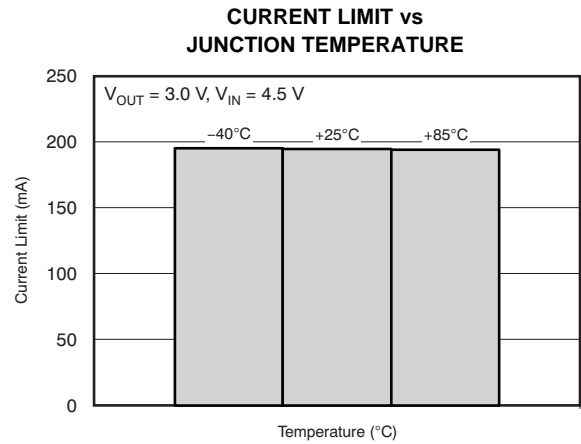

Figure 8.

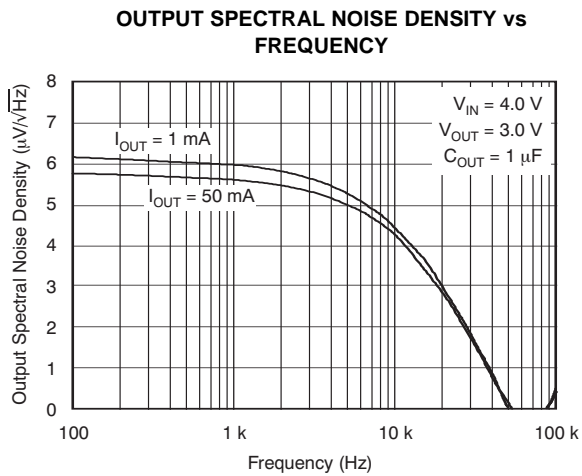

Figure 9.

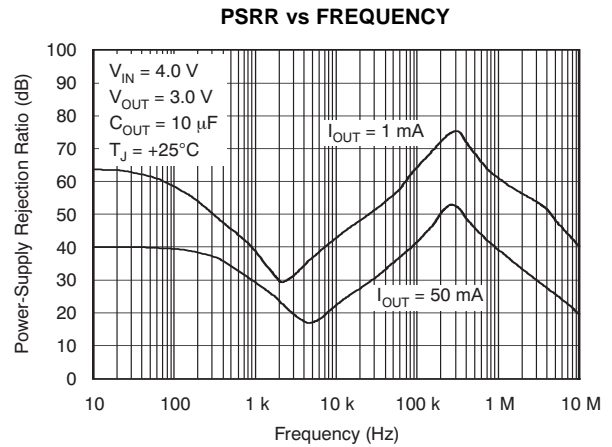

Figure 10.

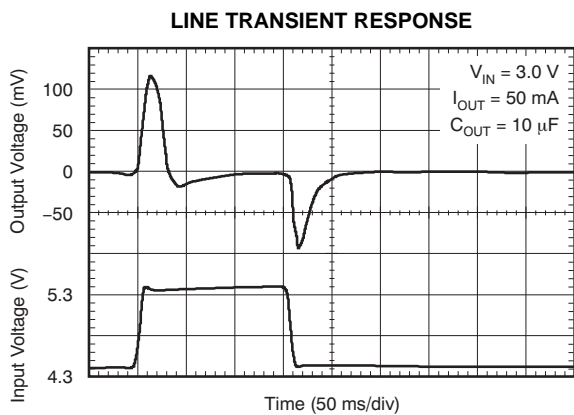

Figure 11.

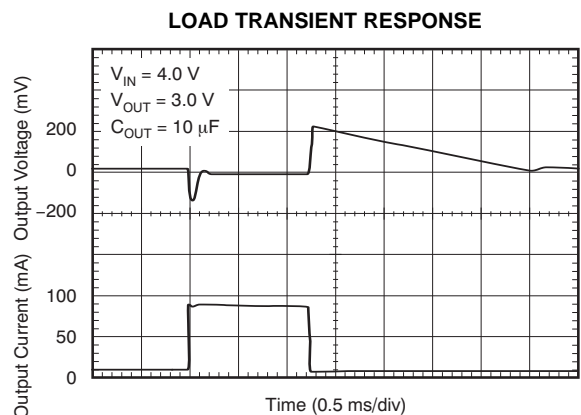

Figure 12.

PRODUCT PREVIEW

APPLICATION INFORMATION

The TLV701xx series of devices belong to a family of ultralow, I_Q , low-dropout (LDO) regulators. I_Q remains fairly constant over the complete output load current and temperature range. The devices are ensured to operate over a temperature range of -40°C to $+125^{\circ}\text{C}$.

INPUT AND OUTPUT CAPACITOR REQUIREMENTS

The TLV701 requires a 1- μF or larger capacitor connected between OUT and GND for stability. Ceramic or tantalum capacitors can be used. Larger value capacitors result in better transient and noise performance.

Although an input capacitor is not required for stability, when a 0.1- μF or larger capacitor is placed between IN and GND, it counteracts reactive input sources and improves transient and noise performance. Higher value capacitors are necessary if large, fast rise time load transients are anticipated.

BOARD LAYOUT RECOMMENDATIONS

Input and output capacitors should be placed as close to the device pins as possible. To avoid interference of noise and ripple on the board, it is recommended that the board be designed with separate ground planes for V_{IN} and V_{OUT} , with the ground plane connected only at the device GND pin. In addition, the ground connection for the output capacitor should be connected directly to the device GND pin.

POWER DISSIPATION AND JUNCTION TEMPERATURE

To ensure reliable operation, worst-case junction temperature should not exceed $+125^{\circ}\text{C}$. This restriction limits the power dissipation the regulator can handle in any given application. To ensure the junction temperature is within acceptable limits, calculate the maximum allowable dissipation, $P_{D(\text{max})}$, and the actual dissipation, P_D , which must be less than or equal to $P_{D(\text{max})}$.

The maximum power dissipation limit is determined using [Equation 1](#):

$$P_{D(\text{max})} = \frac{T_{J\text{max}} - T_A}{R_{\theta\text{JA}}} \quad (1)$$

where:

$T_{J\text{max}}$ is the maximum allowable junction temperature.

$R_{\theta\text{JA}}$ is the thermal resistance junction-to-ambient for the package.

T_A is the ambient temperature.

The regulator dissipation is calculated using [Equation 2](#):

$$P_D = (V_{\text{IN}} - V_{\text{OUT}}) \times I_{\text{OUT}} \quad (2)$$

Power dissipation that results from quiescent current is negligible.

REGULATOR PROTECTION

The TLV701xx series of LDO regulators use a PMOS-pass transistor that has a built-in back diode that conducts reverse current when the input voltage drops below the output voltage (for example, during power-down). Current is conducted from the output to the input and is not internally limited. If extended reverse voltage operation is anticipated, external limiting might be appropriate.

The TLV701xx features internal current limiting. During normal operation, the TLV701xx limits output current to approximately 250 mA. When current limiting engages, the output voltage scales back linearly until the overcurrent condition ends. Take care not to exceed the rated maximum operating junction temperature of $+125^{\circ}\text{C}$. Continuously running the device under conditions where the junction temperature exceeds $+125^{\circ}\text{C}$ degrades device reliability.

The ability to remove heat from the die is different for each package type, presenting different considerations in the printed circuit board (PCB) layout. The PCB area around the device that is free of other components moves the heat from the device to the ambient air. Using heavier copper increases the effectiveness in removing heat from the device. The addition of plated through-holes to heat-dissipating layers also improves heatsink effectiveness. Power dissipation depends on input voltage and load conditions. Power dissipation (P_D) is equal to the product of the output current and the voltage drop across the output pass element, as shown in [Equation 2](#).

PACKAGING INFORMATION

Orderable Device	Status (1)	Package Type	Package Drawing	Pins	Package Qty	Eco Plan (2)	Lead/Ball Finish (6)	MSL Peak Temp (3)	Op Temp (°C)	Device Marking (4/5)	Samples
TLV70130DBVR	ACTIVE	SOT-23	DBV	5	3000	Green (RoHS & no Sb/Br)	NIPDAU	Level-1-260C-UNLIM	-40 to 125	YBVA	Samples
TLV70130DBVT	ACTIVE	SOT-23	DBV	5	250	Green (RoHS & no Sb/Br)	NIPDAU	Level-1-260C-UNLIM	-40 to 125	YBVA	Samples
TLV70133DBVR	ACTIVE	SOT-23	DBV	5	3000	Green (RoHS & no Sb/Br)	NIPDAU	Level-1-260C-UNLIM	-40 to 125	YBWA	Samples
TLV70133DBVT	ACTIVE	SOT-23	DBV	5	250	Green (RoHS & no Sb/Br)	NIPDAU	Level-1-260C-UNLIM	-40 to 125	YBWA	Samples

(1) The marketing status values are defined as follows:

ACTIVE: Product device recommended for new designs.

LIFEBUY: TI has announced that the device will be discontinued, and a lifetime-buy period is in effect.

NRND: Not recommended for new designs. Device is in production to support existing customers, but TI does not recommend using this part in a new design.

PREVIEW: Device has been announced but is not in production. Samples may or may not be available.

OBSELETE: TI has discontinued the production of the device.

(2) **RoHS:** TI defines "RoHS" to mean semiconductor products that are compliant with the current EU RoHS requirements for all 10 RoHS substances, including the requirement that RoHS substance do not exceed 0.1% by weight in homogeneous materials. Where designed to be soldered at high temperatures, "RoHS" products are suitable for use in specified lead-free processes. TI may reference these types of products as "Pb-Free".

RoHS Exempt: TI defines "RoHS Exempt" to mean products that contain lead but are compliant with EU RoHS pursuant to a specific EU RoHS exemption.

Green: TI defines "Green" to mean the content of Chlorine (Cl) and Bromine (Br) based flame retardants meet JS709B low halogen requirements of <=1000ppm threshold. Antimony trioxide based flame retardants must also meet the <=1000ppm threshold requirement.

(3) MSL, Peak Temp. - The Moisture Sensitivity Level rating according to the JEDEC industry standard classifications, and peak solder temperature.

(4) There may be additional marking, which relates to the logo, the lot trace code information, or the environmental category on the device.

(5) Multiple Device Markings will be inside parentheses. Only one Device Marking contained in parentheses and separated by a "-" will appear on a device. If a line is indented then it is a continuation of the previous line and the two combined represent the entire Device Marking for that device.

(6) Lead/Ball Finish - Orderable Devices may have multiple material finish options. Finish options are separated by a vertical ruled line. Lead/Ball Finish values may wrap to two lines if the finish value exceeds the maximum column width.

Important Information and Disclaimer:The information provided on this page represents TI's knowledge and belief as of the date that it is provided. TI bases its knowledge and belief on information provided by third parties, and makes no representation or warranty as to the accuracy of such information. Efforts are underway to better integrate information from third parties. TI has taken and

continues to take reasonable steps to provide representative and accurate information but may not have conducted destructive testing or chemical analysis on incoming materials and chemicals. TI and TI suppliers consider certain information to be proprietary, and thus CAS numbers and other limited information may not be available for release.

In no event shall TI's liability arising out of such information exceed the total purchase price of the TI part(s) at issue in this document sold by TI to Customer on an annual basis.

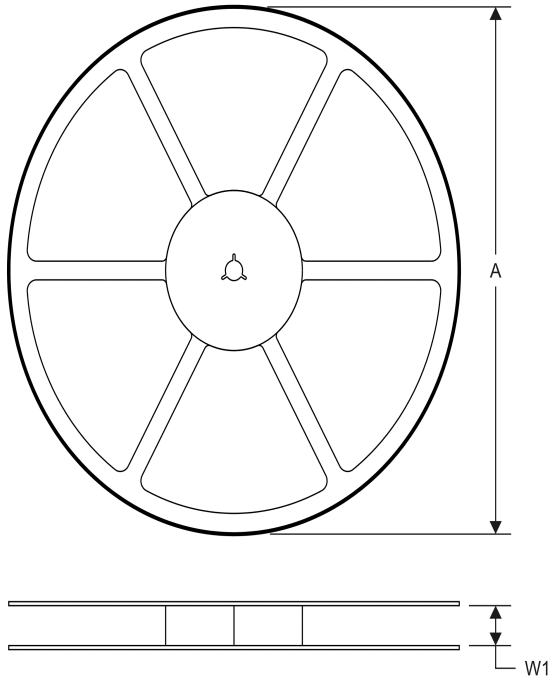
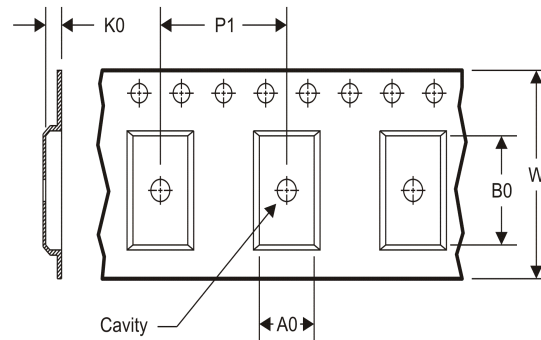
TAPE AND REEL INFORMATION
REEL DIMENSIONS

TAPE DIMENSIONS

A0	Dimension designed to accommodate the component width
B0	Dimension designed to accommodate the component length
K0	Dimension designed to accommodate the component thickness
W	Overall width of the carrier tape
P1	Pitch between successive cavity centers

TAPE AND REEL INFORMATION

*All dimensions are nominal

Device	Package Type	Package Drawing	Pins	SPQ	Reel Diameter (mm)	Reel Width W1 (mm)	A0 (mm)	B0 (mm)	K0 (mm)	P1 (mm)	W (mm)	Pin1 Quadrant
TLV70130DBVR	SOT-23	DBV	5	3000	178.0	9.0	3.23	3.17	1.37	4.0	8.0	Q3
TLV70130DBVT	SOT-23	DBV	5	250	178.0	9.0	3.23	3.17	1.37	4.0	8.0	Q3
TLV70133DBVR	SOT-23	DBV	5	3000	178.0	9.0	3.23	3.17	1.37	4.0	8.0	Q3
TLV70133DBVT	SOT-23	DBV	5	250	178.0	9.0	3.23	3.17	1.37	4.0	8.0	Q3

TAPE AND REEL BOX DIMENSIONS

*All dimensions are nominal

Device	Package Type	Package Drawing	Pins	SPQ	Length (mm)	Width (mm)	Height (mm)
TLV70130DBVR	SOT-23	DBV	5	3000	180.0	180.0	18.0
TLV70130DBVT	SOT-23	DBV	5	250	180.0	180.0	18.0
TLV70133DBVR	SOT-23	DBV	5	3000	180.0	180.0	18.0
TLV70133DBVT	SOT-23	DBV	5	250	180.0	180.0	18.0

EXAMPLE BOARD LAYOUT

DBV0005A

SOT-23 - 1.45 mm max height

SMALL OUTLINE TRANSISTOR

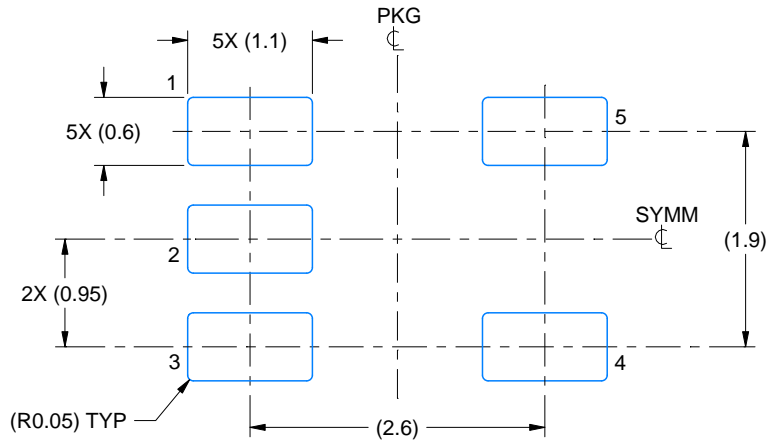

LAND PATTERN EXAMPLE
EXPOSED METAL SHOWN
SCALE:15X

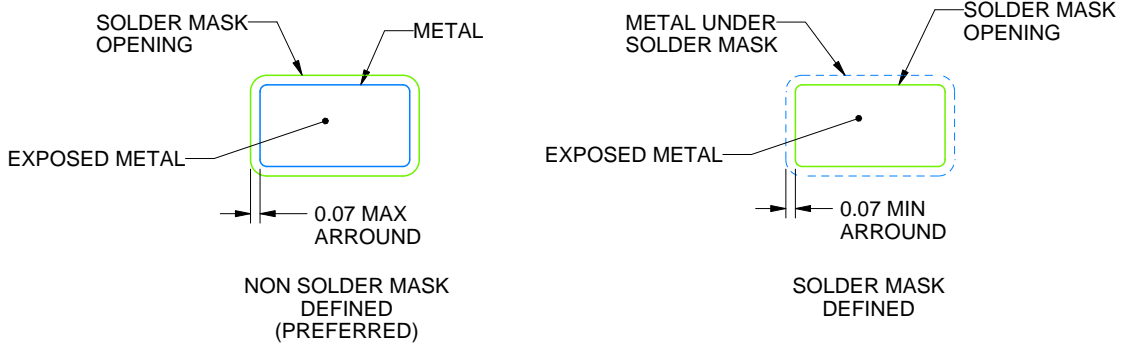

SOLDER MASK DETAILS

4214839/E 09/2019

NOTES: (continued)

- 5. Publication IPC-7351 may have alternate designs.
- 6. Solder mask tolerances between and around signal pads can vary based on board fabrication site.

EXAMPLE STENCIL DESIGN

DBV0005A

SOT-23 - 1.45 mm max height

SMALL OUTLINE TRANSISTOR

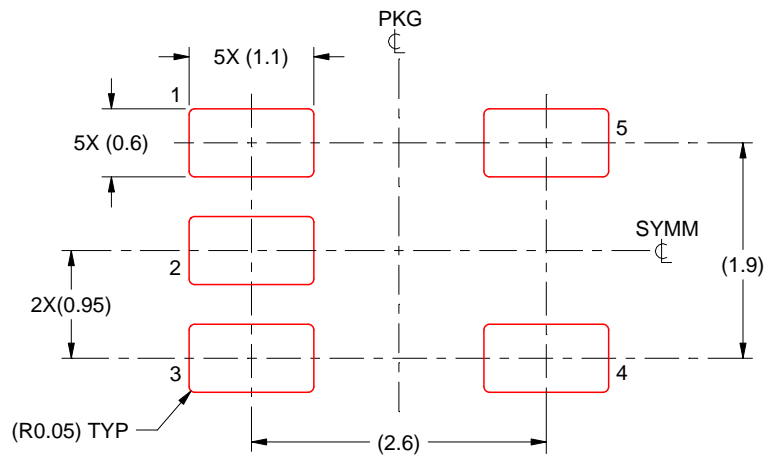

SOLDER PASTE EXAMPLE
BASED ON 0.125 mm THICK STENCIL
SCALE:15X

4214839/E 09/2019

NOTES: (continued)

7. Laser cutting apertures with trapezoidal walls and rounded corners may offer better paste release. IPC-7525 may have alternate design recommendations.
8. Board assembly site may have different recommendations for stencil design.

IMPORTANT NOTICE AND DISCLAIMER

TI PROVIDES TECHNICAL AND RELIABILITY DATA (INCLUDING DATASHEETS), DESIGN RESOURCES (INCLUDING REFERENCE DESIGNS), APPLICATION OR OTHER DESIGN ADVICE, WEB TOOLS, SAFETY INFORMATION, AND OTHER RESOURCES "AS IS" AND WITH ALL FAULTS, AND DISCLAIMS ALL WARRANTIES, EXPRESS AND IMPLIED, INCLUDING WITHOUT LIMITATION ANY IMPLIED WARRANTIES OF MERCHANTABILITY, FITNESS FOR A PARTICULAR PURPOSE OR NON-INFRINGEMENT OF THIRD PARTY INTELLECTUAL PROPERTY RIGHTS.

These resources are intended for skilled developers designing with TI products. You are solely responsible for (1) selecting the appropriate TI products for your application, (2) designing, validating and testing your application, and (3) ensuring your application meets applicable standards, and any other safety, security, or other requirements. These resources are subject to change without notice. TI grants you permission to use these resources only for development of an application that uses the TI products described in the resource. Other reproduction and display of these resources is prohibited. No license is granted to any other TI intellectual property right or to any third party intellectual property right. TI disclaims responsibility for, and you will fully indemnify TI and its representatives against, any claims, damages, costs, losses, and liabilities arising out of your use of these resources.

TI's products are provided subject to TI's Terms of Sale (www.ti.com/legal/termsofsale.html) or other applicable terms available either on ti.com or provided in conjunction with such TI products. TI's provision of these resources does not expand or otherwise alter TI's applicable warranties or warranty disclaimers for TI products.

Mailing Address: Texas Instruments, Post Office Box 655303, Dallas, Texas 75265
Copyright © 2020, Texas Instruments Incorporated