

TL3240 SERIES TACT SWITCH

ANTI-VANDAL SWITCHES
 DETECTOR SWITCHES
 DIP SWITCHES
 KEYLOCK SWITCHES
 NAVIGATION SWITCHES
 PUSHBUTTON SWITCHES
 ROCKER SWITCHES
 ROTARY SWITCHES
 SLIDE SWITCHES
 SNAP ACTION SWITCHES
TACTILE SWITCHES
 TOGGLE SWITCHES
 CAP OPTIONS

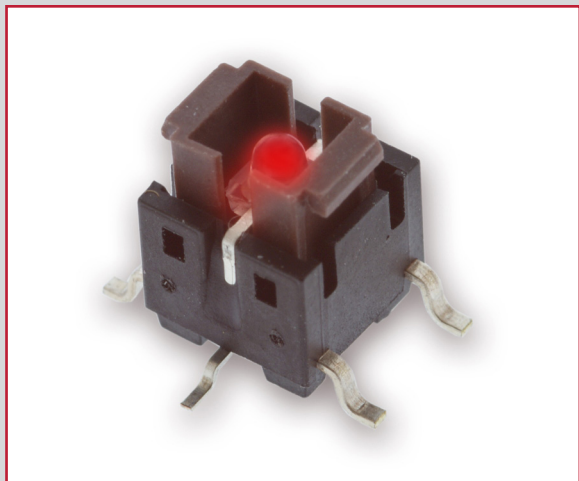

APPLICATIONS / MARKETS

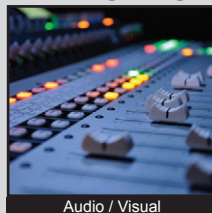

Audio / Visual

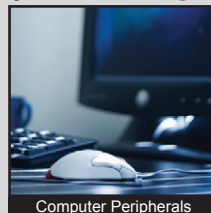

Computer Peripherals



Consumer Electronics

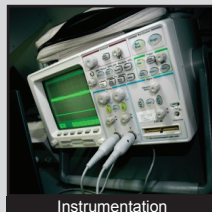

Instrumentation



Telecommunication



Medical Equipment

RoHS

SPECIFICATIONS

Electrical Rating: 50mA @ 12VDC
Life Expectancy: 200,000 Cycles
Contact Resistance: 100mΩ Max.
Insulation Resistance: 100 MΩ Min. at 500VDC
Dielectric Strength: 250VAC for 1 min.
Operating Temperature: -25°C to 70°C
Storage Temperature: -30°C to 80°C
Operating Force: 100 gf; 160 gf; 260 gf
Travel: 0.2mm
Contact Arrangement: SPST, Normally Open

FEATURES & BENEFITS

- Illumination options
- Tape & Reel packaging: 450 pieces per reel
- Caps sold separately
- Surface Mount

PART NUMBER CONFIGURATOR

Series	Model	Force	LED	Cap*	Cap Insert Color
TL	3240	F100 - 100 gf F160 - 160 gf F260 - 260 gf	B - Blue R - Red G - Green Y - Yellow	TL3240R1CAP TL3240S1CAP	BLK - Black RED - Red BLU - Blue IVR - Ivory GRN - Green YEL - Yellow

* Cap to be ordered separately. *They cannot go thru the reflow soldering process.*

Specifications subject to change without notice



E-SWITCH®

www.e-switch.com

800.867.2717

2

TL3240 SERIES TACT SWITCH

BODY DIMENSIONS

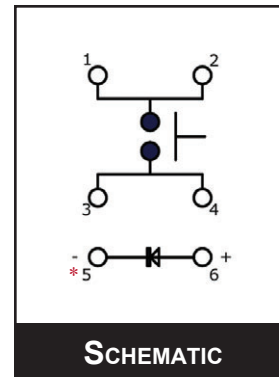
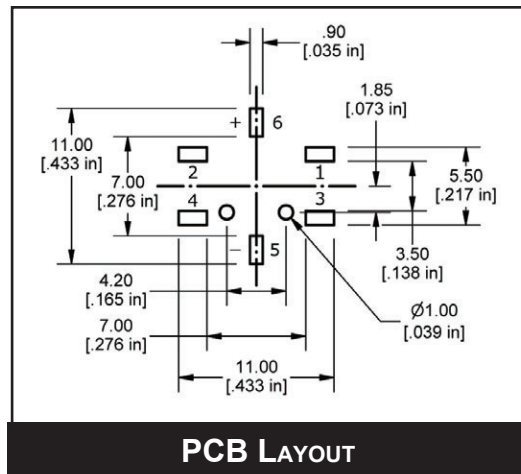
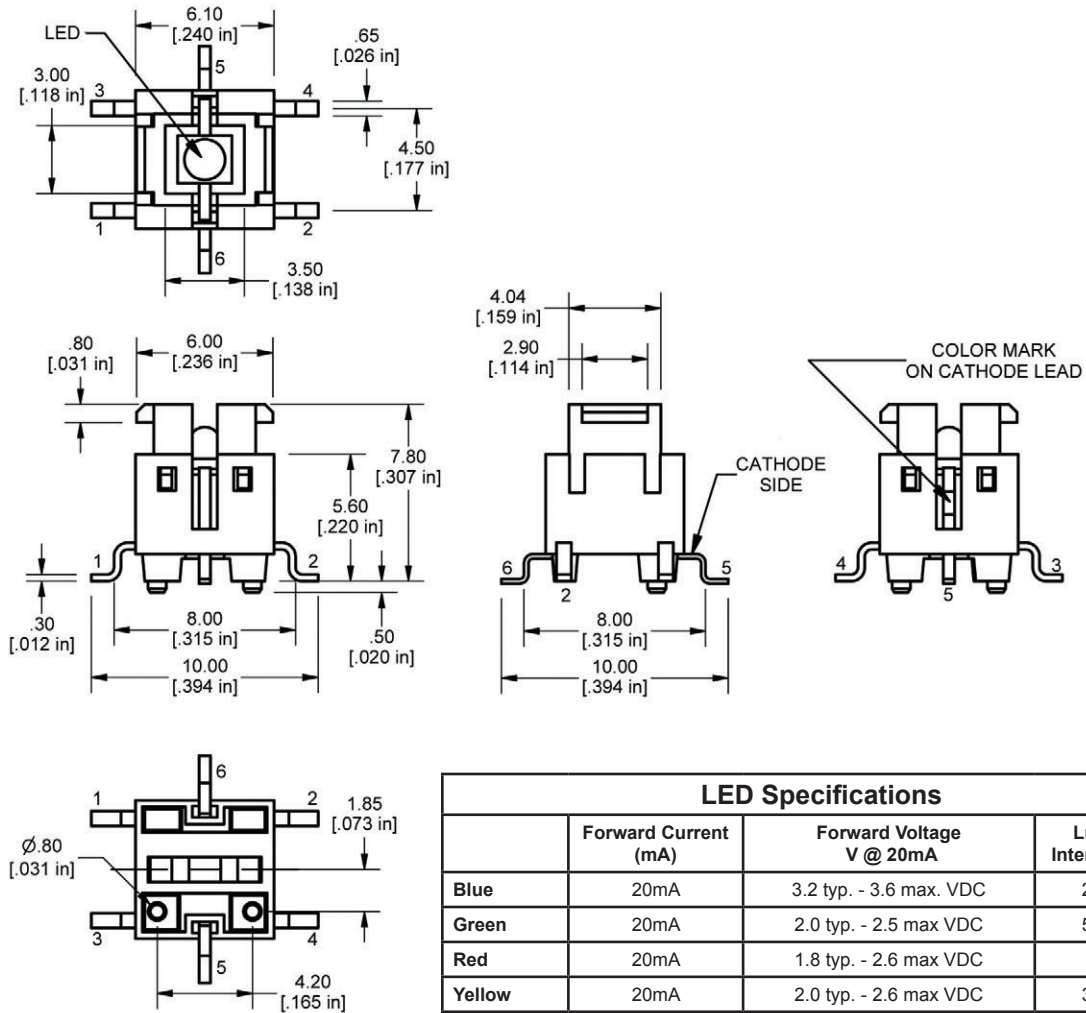

* For the RED LED option, Pin #5 is the anode and Pin #6 is the cathode side of the LED.



ANTI-VANDAL SWITCHES
DETECTOR SWITCHES
DIP SWITCHES
KEYLOCK SWITCHES
NAVIGATION SWITCHES
PUSHBUTTON SWITCHES
ROCKER SWITCHES
ROTARY SWITCHES
SLIDE SWITCHES
SNAP ACTION SWITCHES
TACTILE SWITCHES
TOGGLE SWITCHES
CAP OPTIONS

CAP OPTIONS

Caps are sold separately with a unique part number, as shown in the ordering code on the first page. They CANNOT GO THROUGH THE REFLOW SOLDERING PROCESS. Colors available include red, blue, green, black, ivory and yellow.

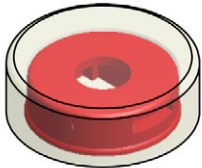

R1 Cap

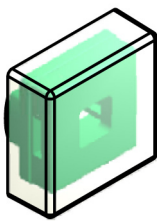
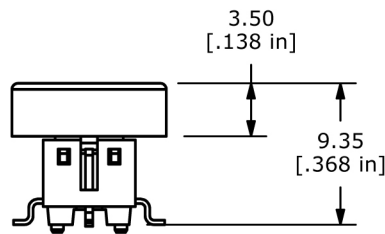
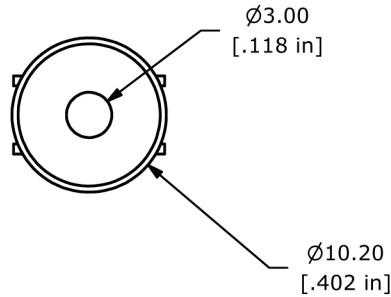

S1 Cap

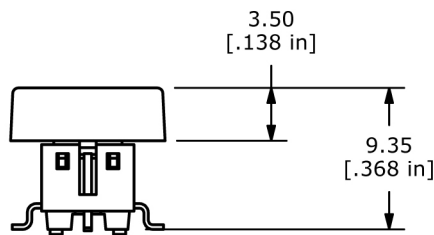
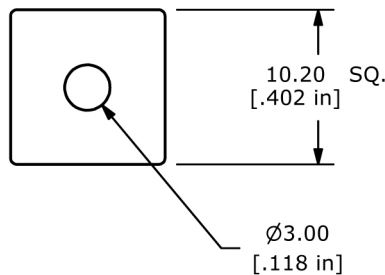

Mouser Electronics

Authorized Distributor

Click to View Pricing, Inventory, Delivery & Lifecycle Information:

E-Switch:

[TL3240F100R](#) [TL3240S1CAPRED](#) [TL3240R1CAPBLK](#) [TL3240R1CAPRED](#) [TL3240F160R](#) [TL3240F160Y](#)
[TL3240S1CAPYEL](#) [TL3240R1CAPIVR](#) [TL3240F260Y](#) [TL3240S1CAPBLK](#) [TL3240S1CAPIVR](#) [TL3240F160B](#)
[TL3240R1CAPBLU](#) [TL3240S1CAPBLU](#) [TL3240R1CAPYEL](#) [TL3240S1CAPGRN](#) [TL3240F160G](#) [TL3240F260B](#)
[TL3240R1CAPGRN](#) [TL3240F100B](#) [TL3240F100Y](#) [TL3240F260G](#) [TL3240F100G](#) [TL3240F260R](#) [TL3240F100PG](#)